

JANUARY, 1925

25 CENTS

RADIO

(Reg. U. S. Patent Off.)



W
ANDREWS

IMPROVED
45,000 CYCLE
SUPER-HETERODYNE

RADIO FREQUENCY
AMPLIFICATION

HARMONIC
TRANSMISSION

ENERGY COUPLING



Hear Him
by RADIO
in your home

Funny? He's a Riot, a Laugh Factory, A Fifth Alarm!!! The whole nation knows his name and fame.

But how few can actually see him in person!!!

Radio leaps the Barriers of Time and Distance. Listen-in when next he's on the air. Cunningham Radio Tubes make Clear Reception a Certainty. Why gamble on sub-standard equipment for the nerve-center of your set? More than ever — Quality Counts.



Since 1915
Standard for All Sets

Types C-301A, C-299, C-300, C-11 and C-12, in the Orange and Blue Carton.

PATENT NOTICE: *Cunningham Tubes* are covered by patents dated 2-18-12, 12-30-13, 10-23-17, 10-23-17, and others issued and pending.

Cunningham 40-page Data Book fully explaining care and operation of Radio Tubes now available by sending 10c in stamps to San Francisco Office.

Cunningham **RADIO TUBES**

E. J. Cunningham Inc.

Branch
CHICAGO

Home Office:
182 SECOND ST.,
SAN FRANCISCO, CALIF.

Branch
NEW YORK

Tower's

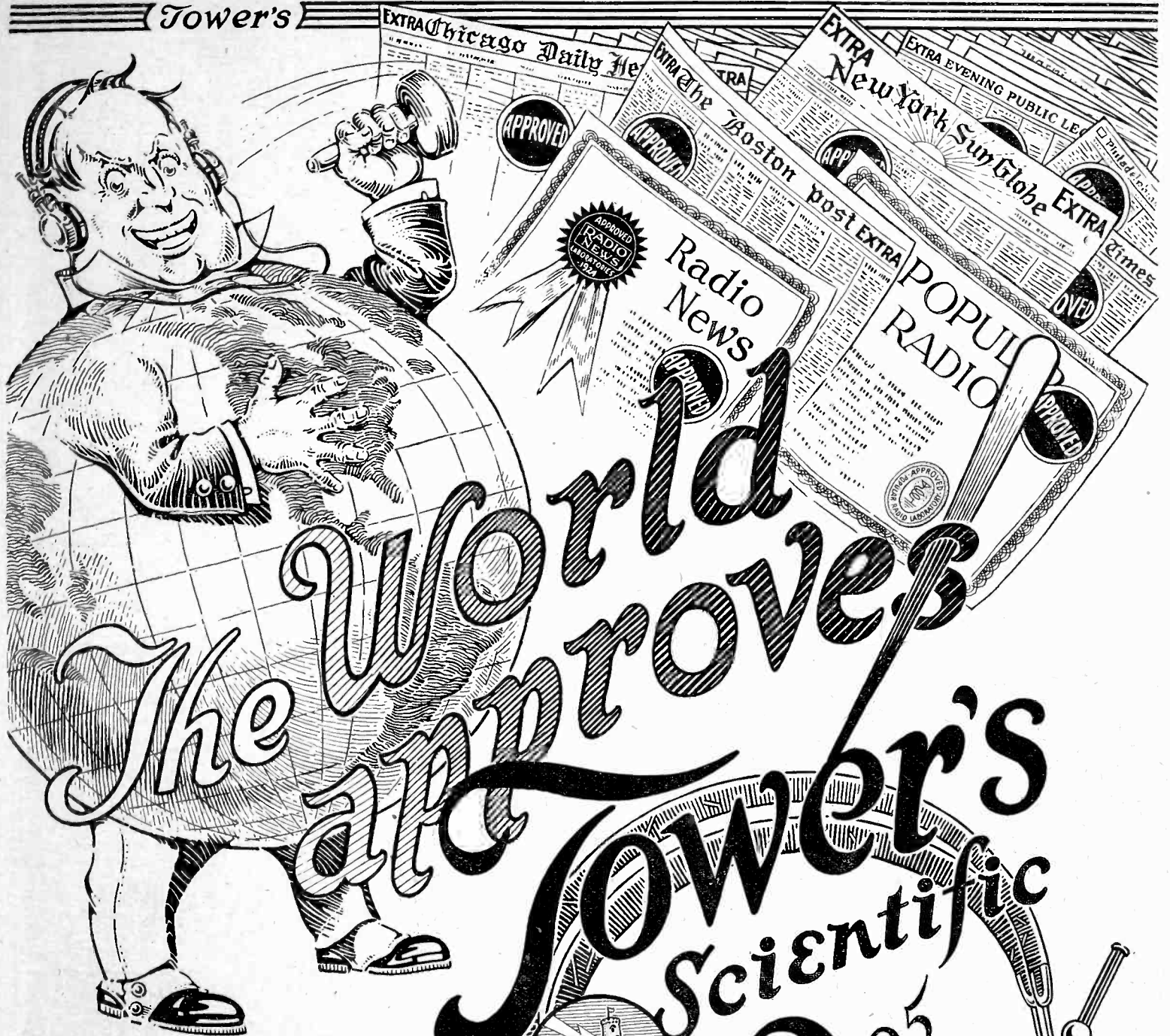

Undisputed leadership

Every Set Tested and approved by Government licensed Radio operators, thus guaranteeing uniform tone quality and accuracy.

TOWERS SCIENTIFICS have been approved by the Testing Laboratories of The Leading Newspapers and Magazines the World Over.

Such recognized merit guarantees positive assurance of Supreme Quality, making TOWERS SCIENTIFICS the logical phone to buy.

Tower's *Scientific* Headsets are guaranteed to be made of the best materials money can buy---highest test enamel, insulated magnet wire, best grade five-foot tinsel cord, unbreakable caps, polished aluminum cases, using the famous scientific head-band constructed for maximum comfort.



If your dealer cannot supply you, order direct by post card, and we will ship immediately Parcel Post, C. O. D., plus a few cents postage.

THE TOWER MFG. CORP., 98 Brookline Ave., Dept. E BOSTON, MASS.

Scientific

Tell them that you saw it in RADIO

RADIO

Established 1917

Published Monthly by the Pacific Radio Publishing Co.

ARTHUR H. HALLORAN, Editor

LAWRENCE MOTT,
Associate Editor

H. W. DICKOW,
Advertising Manager

Branch Offices:

New York City—17 W. 42nd St.
Chicago—157 E. Ontario St.
Boston—52 Irving St.
Kansas City, Mo.—1102 Republic Bldg.

Rates:

Issued Monthly, 25c a copy.
Subscription price \$2.50 per year
in the U. S., \$3.00 per year
elsewhere.

Entered as second-class matter at the Post Office at San Francisco, Calif.
Copyright 1924, by the Pacific Radio Publishing Co.

Correct Addresses:

Instructions for change of address should be sent to the publisher two weeks before the date they are to go into effect. Both old and new addresses must always be given.

Advertising:

Advertising Forms Close on the First of the Month Preceding Date of Issue.

Address all communications to

Pacific Radio Publishing Company

Pacific Building, San Francisco, California

VOLUME VII

JANUARY, 1925

NUMBER 1

CONTENTS

RADIOTORIAL COMMENT	9
THE IMPROVED 45,000 CYCLE SUPER-HETERODYNE	10
ROUND'S ROUND GROUND	15
<i>By Ferd Humphreys</i>	
SOME NOVEL IDEAS IN RECEIVER CONSTRUCTION	17
<i>By E. E. Griffin</i>	
THE COMMERCIAL TESTING OF A REGENERATIVE SET	20
<i>By H. Diamond</i>	
MAKING THE SINGLE CIRCUIT SELECTIVE	22
<i>By H. A. Nickerson</i>	
THE JONAH OF JASMINE BJONES	23
<i>By George Sumner Albee</i>	
THE REACTANCE COUPLED AMPLIFIER	24
<i>By L. R. Felder</i>	
AN IMPROVED INTERFERENCE ELIMINATOR	26
<i>By F. L. Ulrich</i>	
RESISTANCE CONTROL OF REGENERATION IN TUNED CIRCUIT RADIO FREQUENCY AMPLIFIERS	
<i>By C. M. Jansky, Jr.</i>	
MORE ABOUT THE HARMONIC TRANSMITTER	29
<i>By F. Dawson Bliley</i>	
A USEFUL MOLDABLE MATERIAL	30
<i>By Samuel G. McMeen</i>	
A NEW COUPLING SYSTEM FOR TRANSMITTING STATIONS	31
<i>By D. B. McGown</i>	
A FEATHERWEIGHT MAST	32
<i>By F. K. Leslie</i>	
THE "C" BATTERY PRODUCES A SURPRISE	33
<i>By L. W. Hatry</i>	
QUALIFYING FOR AN OPERATOR'S LICENSE	34
<i>By Kennard McClees</i>	
A RADIO SET TROUBLE SHOOTER	35
<i>By Sidney L. Goodwin and Arthur L. Smith</i>	
QUERIES AND REPLIES	37
LETTERS TO THE EDITOR	39
CALLS HEARD	40
WITH THE AMATEUR OPERATORS	41
NEW APPARATUS AND SUPPLIES	42

Forecast of Contributions for February Issue

C. M. Jansky, Jr., continues his illuminating comment on various types of radio frequency amplification.

Volney G. Mathison has designed a receiver capable of efficiently covering the range from 300 to 30,000 meters and bringing in all the trans-oceanic high-power stations of the world to any location. He gives full details of the how and why of its construction.

In this day of an ever-increasing number of radiocast stations especial interest attaches to Maurice Buchbinder's article on "Selectivity, and How to Get It."

The man who wants to work six loudspeakers off of one receiving set will be greatly encouraged and helped by B. F. McNamee's account of "The Multi-Speaker Amplifier," which he recently installed.

An experimenter's short wave, low loss tuner, simple in construction and low in cost, is described by Carlos G. Mundt.

E. F. Kierman discusses "Reactance, Capacity and Phase Angle" in terms that can be comprehended by the dumbest of us.

Howard F. Mason asks and answers the question, "Are the Short Waves New?" in a most interesting manner. Incidentally he is now back in Seattle and will be a frequent contributor to these columns in the future.

Mickey Doran, in the third of his series of "Letters of a Deep Sea Op." discusses a novel method of long wave reception with the Navy type receivers.

Brainard Foote submits a helpful contribution on a one-tube combination receiver and transmitter which gets its high voltage supply from a spark coil, these requiring no other power supply beyond a storage battery.

L. R. Felder describes the "Mechanism of Radiophone Reception" for the benefit of the novices. Another simple article is "The Elements of Tuning" by Kennard McClees.

Three fine articles have been prepared especially for the amateur interested in short wave transmission. Gaston B. Ashe presents some excellent material on "Short Wave Antennas." L. J. N. du Treil gives constructional details for a wavemeter having a range from 18 to 350 meters. D. B. McGown describes "A Constant Frequency Tube Transmitter."

The fiction feature is an unusual radio story by Earle Ennis, "C Q' Watts—Bum!"

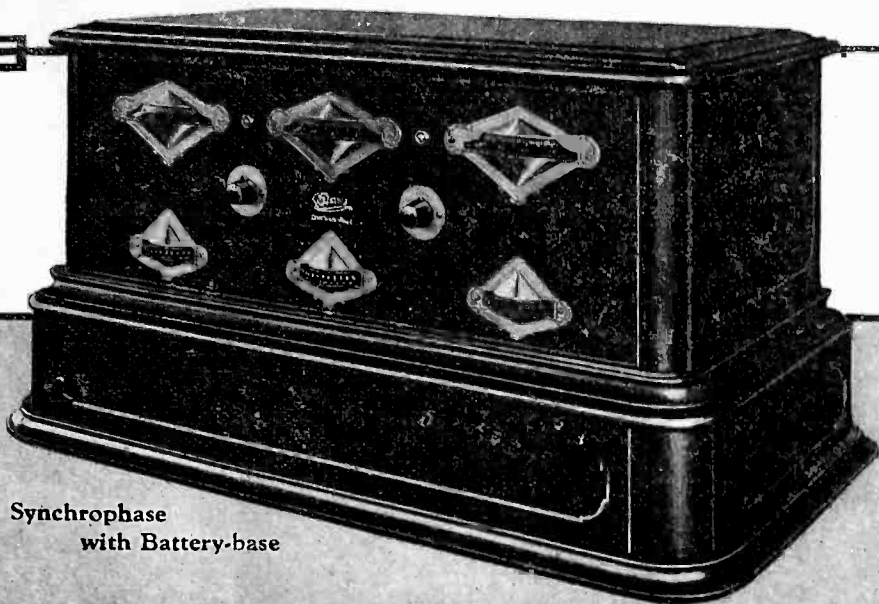

Synchrophase
with Battery-base

It Is WRITTEN:

"A slight deviation
leads to a great er-
ror."

There are no devia-
tions, however slight,
in the making of a
Synchrophase; each
is a masterpiece.

Doctor Mu

THE GREBE

SYNCHROPHASE

TRADE MARK

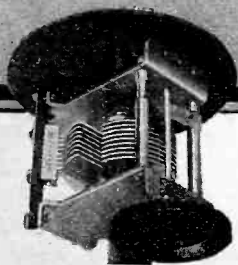

Synchrophase Secrets
No. 2 The S-L-F Condenser
(Straight line frequency)

This ingenious device elim-
inates the crowding of low
wave stations toward the lower
end of the dials; the settings
for the various broadcast sta-
tions being spaced at equal in-
tervals around the dials. The
circuits are so arranged that
the settings for a given station
are identical on all three dials.

The S-L-F Condenser makes
the Synchrophase a receiver
that is unrivalled in its sim-
plicity and ease of dependable
operation.

INTO this masterpiece of design and craftsmanship are
built the knowledge and experience gained during
fifteen years by the manufacturer who stands pre-emi-
nent in the industry.

Binocular coils give the Synchrophase a degree of
selectivity found in no other receiver. Two stages of bal-
anced tuned radio frequency—the result of exhaustive
research—are responsible for its unsurpassed sensitivity.
Its thorough ease of operation is made possible by the
S-L-F condensers and a volume control giving an un-
broken range of six variations of audio amplification.

To see the Synchrophase is to appreciate its charm;
to operate it, is to realize its true excellence.

Ask your dealer, or write us for literature.

A. H. GREBE & COMPANY, INC.

Van Wyck Blvd., Richmond Hill, N.Y.

Western Branch: 443 So. San Pedro St., Los Angeles, Cal.

All Grebe apparatus is covered by patents granted and pending.



TRADE MARK
REG. U.S. PAT. OFF.

THIS COMPANY OWNS AND OPERATES STATION WAHG.



ALL-AMERICAN

Fills Every Radio Requirement

If You Want to Improve Your Present Set ~



If You Want to Build a High Grade Receiver ~



Install genuine ALL-AMERICAN Audio Transformers. Two of these instruments, fitted into any set not already equipped with them, will give the receiver greater loud-speaker volume with remarkable purity of tone. ALL-AMERICAN Transformers are so designed that they amplify fundamentals and harmonics equally, throughout practically the entire audible range. Hence, voice and tones are reproduced *faithfully*.

The standards of precision to which ALL-AMERICANS are made, have led to their adoption as standard equipment on all the better sets.

Insist upon ALL-AMERICANS: the Audio Transformers which, through sheer merit, have become the largest selling transformers in the world. 3 to 1 Ratio, \$4.50; 5 to 1 Ratio, \$4.75; 10 to 1 Ratio, \$4.75.

Use ALL-AMERICAN Super-Fine Parts, and you can have an intermediate-frequency receiver embodying all the most advanced features known in Radio.

Super-Fine Parts are easily installed. No critical adjustments are necessary. Operation is smooth and flawless. And every part is ALL-AMERICAN—if you are a Radio Fan you know what that means! Sets built with Super-Fine Parts are unsurpassed for selectivity, range, volume, and tone quality. Practically any station in the country can be brought in on the loud-speaker. Interference from local stations is completely eliminated. Reliability is assured through ALL-AMERICAN precision in manufacturing. Super-Fine Parts represent in a very real sense *the ultimate* in radio broadcast reception. Price, \$26.00

ALL-AMAX JUNIOR

An All-American One-Tube Reflex

This is the ideal set for the youthful beginner in Radio. It comes completely mounted on panel and baseboard, and can be easily wired in one delightful evening with the aid of clear photographs and a 43-page instruction book. Easy to tune—as selective as a multi-tube set—has “crystal” tone quality—volume enough for speaker operation. It brings in far-distant stations, and tunes out the locals.

Price, complete (semi-finished) \$22.00

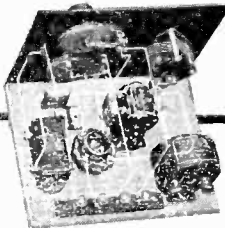

The Radio Key Book

Will help anyone to hear farther and better. Contains practical hints for the set builder—tested hookups—diagrams of All-Amax and other circuits. Sent for 10 cents, coin or stamps

RAULAND MFG. CO.

2654 Coyne St., Chicago

Pioneers in the Industry

ALL-AMAX SENIOR

An All-American Three-Tube Reflex

A complete receiver of the highest type. Great range and selectivity are provided by three stages of tuned and SELF-TUNED Radio Frequency Amplification. A crystal detector and two stages of Standard ALL-AMERICAN-equipped Audio, insure speaker volume on distant stations, with undistorted tone quality. Completely assembled—full directions for wiring.

Price, complete (semi-finished) \$42.00

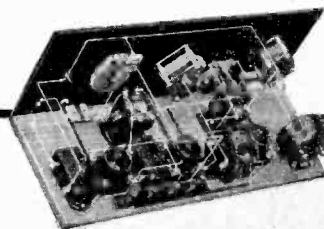

Largest Selling Transformers in the World

A Message FROM **MARS**

THE possibility of radio communication with Mars is doubtful but the merit of the Rectigon battery charger is a certainty.

Tune up your radio batteries with the Rectigon. Keep the A and B batteries of your set in constant readiness to receive distant stations.

The Rectigon charges radio batteries over-night at less than one-tenth of the price paid for the same service at the battery station.

It charges Automobile batteries, too.

The Rectigon weighs only a few pounds and is no more trouble to install than a light bulb. Send for folders F-4584 and F-4585, they are revelations on battery charging.

Westinghouse Electric & Manufacturing Company
George Cutter Works, South Bend, Indiana
Sales Offices in All Principal Cities of
the United States and Foreign Countries



Westinghouse

Tell them that you saw it in RADIO

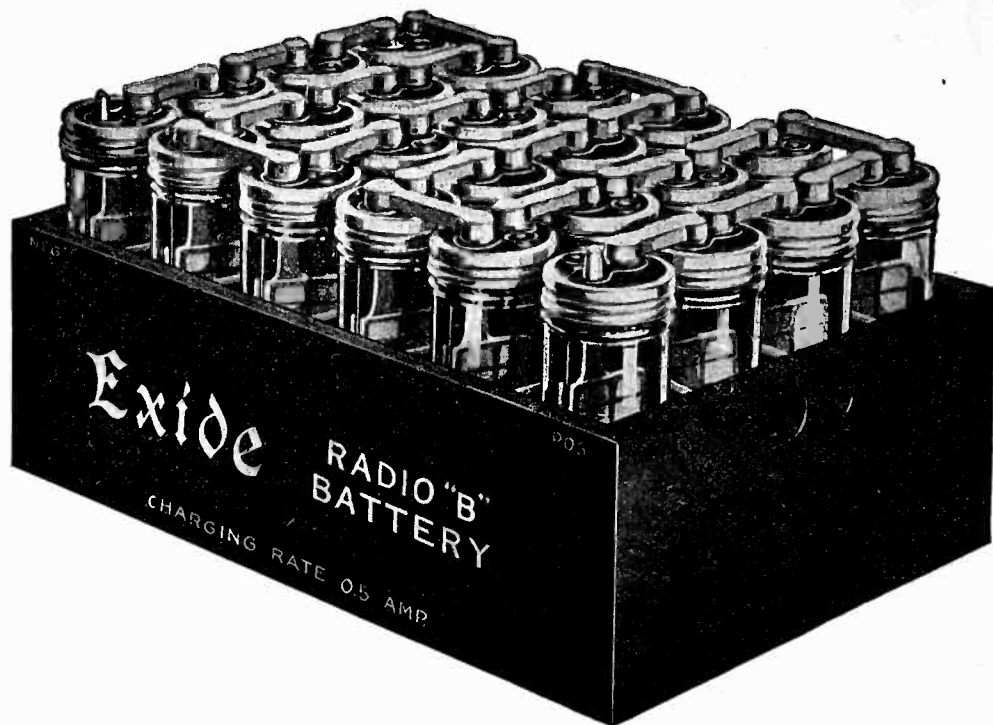

This new "B" battery has capacity and visibility

IF you are fortunate enough to own one of the larger sets you should be specially interested in the new Exide "B" Battery.

This new "B" battery, which is obtainable in 24-volt and 48-volt units, has a capacity of 6000 milliampere hours. It is full-powered and noiseless, maintaining a constant voltage on the plate at all times.

The cells are made of glass, which enables you to see at a glance the condition of plates and separators and the amount of electrolyte. The cell covers are of hard rubber and hold the plates suspended. You need not fear breakage in this battery.

A complete line of Radio Batteries

The new Exide Rectifier, compact and efficient, in a heavy glass jar, makes it possible

to recharge your "B" battery from your house current at a cost that is insignificant.

You can find in the Exide Radio line the right battery for every need. In addition to the glass jar "B" batteries, there are 6-volt, 4-volt and 2-volt "A" batteries—all conservatively rated and all long-lived.

Remember: Exide Batteries are used by a majority of the government and commercial radio plants. They are made by the largest manufacturer in the world of storage batteries for every purpose.

Ask to see the Exide Radio line at any Exide Service Station or at your Radio Dealer's.

THE ELECTRIC STORAGE BATTERY COMPANY
PHILADELPHIA

In Canada, Exide Batteries of Canada, Limited
153 Dufferin Street, Toronto

Exide

RADIO BATTERIES

FOR BETTER RADIO RECEPTION USE STORAGE BATTERIES

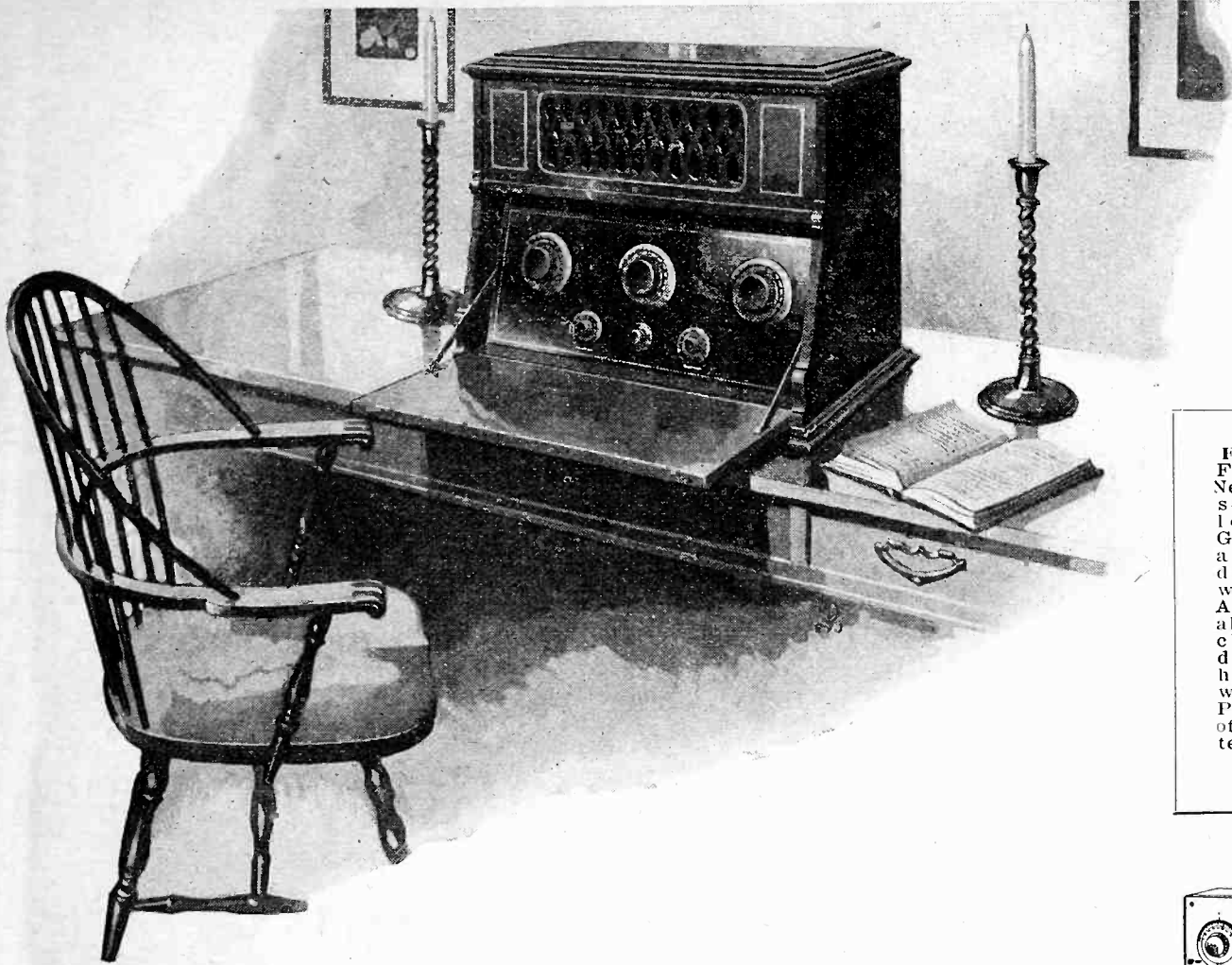

FADA Neutrola
 Five-tube FADA Neutrodyne, with self-contained loud speaker. Genuine mahogany, artistically decorated with wooden inlay. Ample space for all batteries and charger. Drop desk lid that hides receiver when not in use. Price (exclusive of tubes and batteries, \$220.

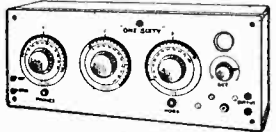

FADA "One Sixty"
 No. 160-A
 "The receiver that has taken the country by storm." The best known of all Neutrodynes. Four tubes. Price (less tubes, batteries, etc.) \$120.

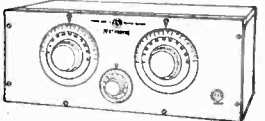

FADA Neutro Junior
 No. 195
 Three-tube Neutrodyne. A wonderful performer. Price (less tubes, batteries, etc.) \$75.

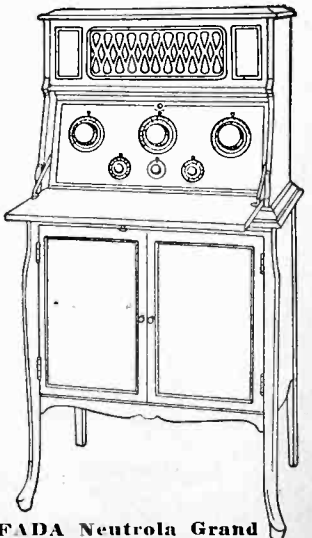

FADA Neutrola Grand
 No. 185/90-A
 The five-tube Neutrola 185-A, mounted on FADA Cabinet Table No. 190-A. Price (less tubes, batteries, etc.) \$295.

Natural tone quality . . . wonderful volume with a FADA Neutrola

In the "Neutrola," FADA has produced a radio receiver that possesses every essential to your complete enjoyment of radio. It is a new and better designed five-tube Neutrodyne set, refined to give the most faultless reproduction of music and voice. You can, without exaggeration, imagine yourself in the very presence of the musicians and artists.

Selectivity is but one remarkable feature of the "Neutrola." With powerful local broadcasting stations operating, the "Neutrola" cuts through them and brings in outside stations, hundreds of miles away, on the loud

speaker, with a minimum of interference.

The "Neutrola" cabinet is of genuine mahogany, inlaid with a lighter wood. A decorative grill covers the built-in loud speaker, and a drop desk lid hides the panel when the set is not in use. The "Neutrola" is fitting company to the finest furniture in the home.

In addition to the "Neutrola" there are other FADA Neutrodyne receivers in sizes and styles to meet every desire; three, four and five tube receivers in plain and art cabinets at prices ranging from \$75 to \$295, each extraordinary in results; each a remarkable value—at your dealer's.

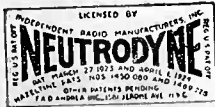

F. A. D. ANDREA, INC., 1581 JEROME AVENUE, NEW YORK

FADA Radio

Tell them that you saw it in RADIO

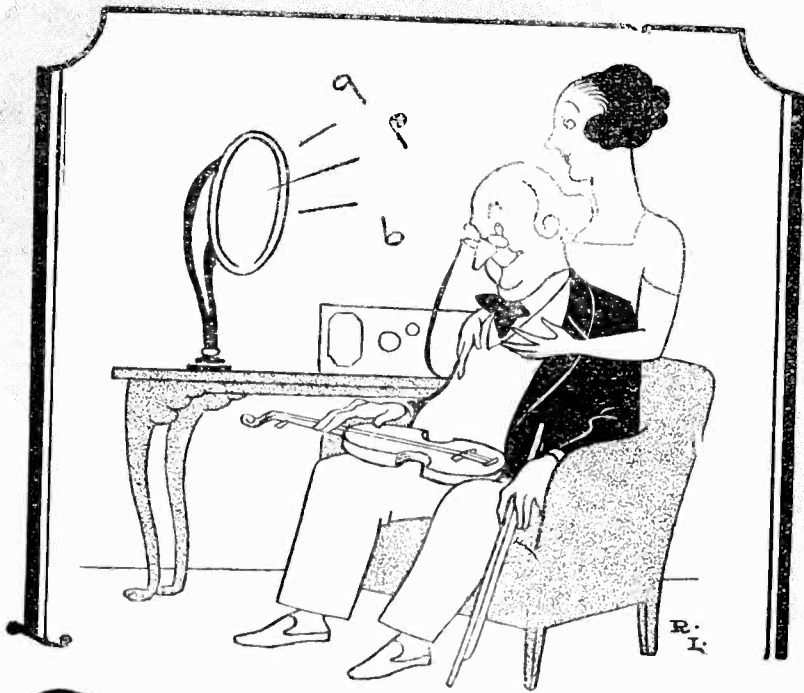

Radiola Loudspeaker
Type UZ-1325
Now \$25.00

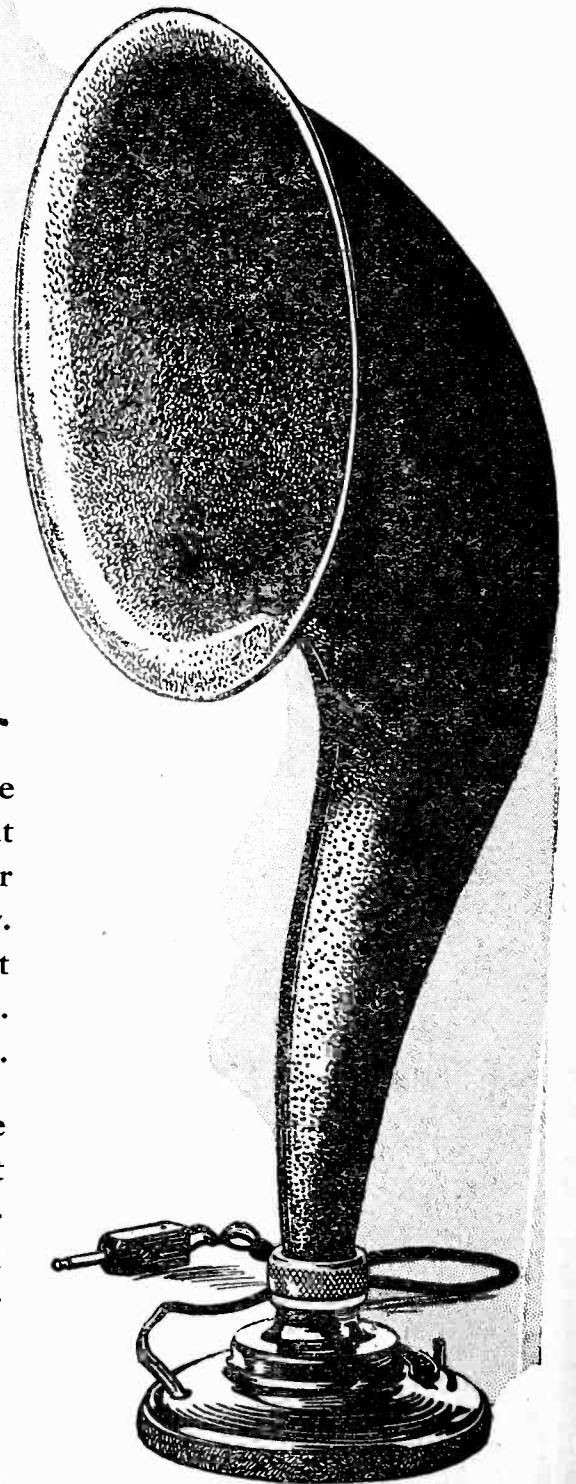

Music for the critical

Time was when people were so impressed with the wonder of radio, and so entertained by the fun that came over, that they actually didn't mind the bluster of a noisy horn. But most of us aren't like that now. We want music that is music—we want speech that is really human speech—unclouded by horn sounds. And we can have it now—with a Radiola Loudspeaker.

You cannot blame every extraneous sound on the loudspeaker. But if your set is working perfectly, all it needs, to give you clear, faithful, undistorted reproduction, is a Radiola Loudspeaker. Hear one today, and if you really want to judge the difference, ask to hear it in competition with others.

Radiola

REG. U. S. PAT. OFF.

LOUDSPEAKER

This symbol of quality  is your protection

RADIO CORPORATION OF AMERICA

Sales Offices:

233 Broadway, New York
10 So. La Salle St., Chicago, Ill.
28 Geary St., San Francisco, Cal.

RADIO

Established 1917

Volume VII

JANUARY, 1925

Number 1

Radiatorial Comment

AT the beginning of the new year it is customary to review the outstanding accomplishments of the old. Upon looking back over 1924, the most important developments have been those in connection with short-wave transmission and reception. While the merits of these higher frequencies were known years ago, they were not put to much practical use until 1924. While they were applied in a small way to radiocasting and other commercial work, their greatest application was by the amateurs, to whom great credit is due. As a consequence there has been a tremendous revival of interest in amateur transmission.

The year will be memorable because it marked the virtual cessation of amateur spark transmission and the gradual sharpening of the wave of ship spark sets.

The recent tendency toward greater power for radiocast stations was recognized by the granting of revocable, experimental licenses for a number of stations whose ultimate power may be 5,000 watts and for one 40,000-watt station. It is as yet too early to state whether these will be permanent, as their actual effects are not well enough known.

Definite results were accomplished in trans-oceanic communication along both the Atlantic and Pacific coasts. The amateur and radiocast stations may soon cause the commercial stations to look to their laurels in long distance work.

Receivers have been greatly improved in selectivity, sensitivity and simplicity of control. Considerable progress has been made in reducing radiation from regenerative receivers both in design and in operation. The early favor of the neutrodyne in popular estimation was later shared by the super-heterodyne. Tuned radio frequency sets of other types were also perfected and bid fair to be favorites in 1925. Low-loss tuners and low-capacity tubes were factors contributing to this progress.

There has been a decided trend toward the music dealer and the automotive supply house as the retail outlet, perhaps one result of the finer cabinets adopted by many manufacturers. The volume of business was well in excess of a million dollars a day.

The patent situation has been somewhat clarified, but there still remains much to be done in preventing infringement and actual copying of designs and trademarks. This has been so flagrant in the case of vacuum tubes that it is

difficult to determine whether a tube is genuine or bootleg.

Unfortunately there has been but little progress in securing adequate laws for regulating radio. The third radio conference made many constructive suggestions which were adopted, but the Department of Commerce still lacks the power of enforcement if it comes to a show-down.

CONSIDERABLE criticism has been directed against the superintendent of the Yosemite National Park in California for prohibiting the use of outside aerials for radio reception and transmission in Yosemite Valley. At first thought this seems virtually to exclude radio from one of America's greatest playgrounds and seems especially to work a hardship on the permanent residents.

His objection to the outside aerial is that it is unsightly, tending to mar the beauty of the scenery, and that the Park employees have to tear down the carelessly constructed aerials of the visitors at the cost of considerable time and effort. If permission is given to one it must be given to all. This objection is reinforced by the progress that is being made in putting all overhead power and telephone lines underground so that eventually there shall be no unsightly poles and wires in this favored spot. This is being done as rapidly as funds permit.

Should the prohibition of outside aerials actually exclude radio from the valley we would be inclined to undertake an educational campaign to have him reverse his decision. But inasmuch as good reception is possible on a three-tube receiver using an inside aerial strung under the rafters or on a set capable of functioning with a loop, and furthermore as transmission is also possible under these conditions we agree with Superintendent Lewis that his prime duty is to preserve the natural beauty of the valley.

The privilege of an outside aerial is one of the advantages that must be sacrificed by those fortunate enough to live in this wonderful spot. Just as the residents of the District of Columbia are not entitled to vote, so, by law, the residents of any national park must conform to the regulations issued by constituted authority. If anyone objects he has the simple remedy of changing his residence.

The Improved 45,000 Cycle Super-Heterodyne

Revised Constructional Details for a Moderate Cost Receiver Unexcelled in Selectivity Sensitivity, Operating Simplicity and Tone Quality and Practically Non-Radiating with a Loop

EXPERIENCE in building the super-heterodyne receiver first described in May, 1924, RADIO has demonstrated that an even more efficient set can be made with apparatus now available and by a slight rearrangement of the parts. This rearrangement consists principally in shortening the panel, arranging the apparatus in a smaller space, deepening the baseboard, and placing most of the tubes on a shelf, thereby shortening the connecting leads. The power output of the set is greatly increased by replacing the last stage of audio frequency amplification with a UV-201-A or C-301-A tube. No extra controls have been added, and the use of the C battery has been retained, since a practical method of eliminating it seems to be beyond the capabilities of most radio constructors.

Without going into the detailed theory of the super-heterodyne, it is desirable to describe briefly what takes place in the various parts of the receiver. The incoming frequency, which is intercepted by the loop or outdoor antenna, is fed into the first detector tube. This frequency varies from 600-

000 to 1,500,000 cycles per second, depending upon the station wavelength.

As it is difficult to amplify this high frequency with the ordinary vacuum tube, due to inter-electrode capacity as well as other causes, some means of lowering the incoming frequency to a value somewhere within the range of efficient operation of the amplifier must be found. Hence, by introducing into this first detector tube an additional frequency, different in value from the incoming frequency, a third frequency, equivalent to the difference between the first two, is produced. This process is

known as heterodyning, the word from which the circuit derived its name.

As successful multi-stage amplifiers are more easily constructed for frequencies below 100,000 cycles, this third frequency should be below that value. A careful analysis proved that the most satisfactory frequency lay between 40,000 and 50,000 cycles, leading to the choice of 45,000 cycles as a desirable frequency for this set.

Therefore, assuming that the incoming frequency is 1,000,000 cycles, it is only necessary to set the oscillator, or generator of the second frequency, at

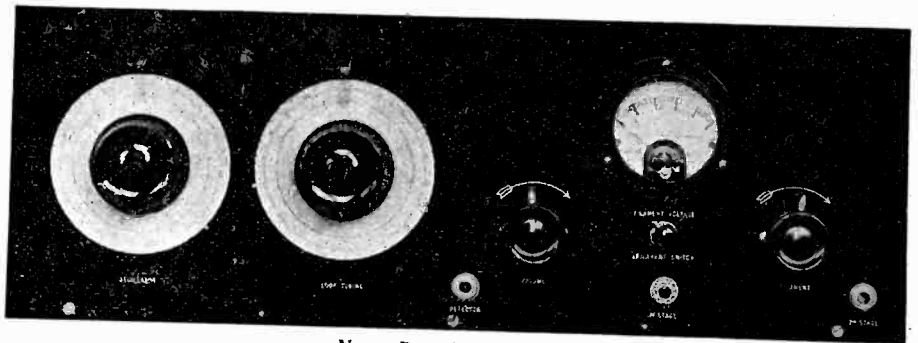

New Panel Arrangement

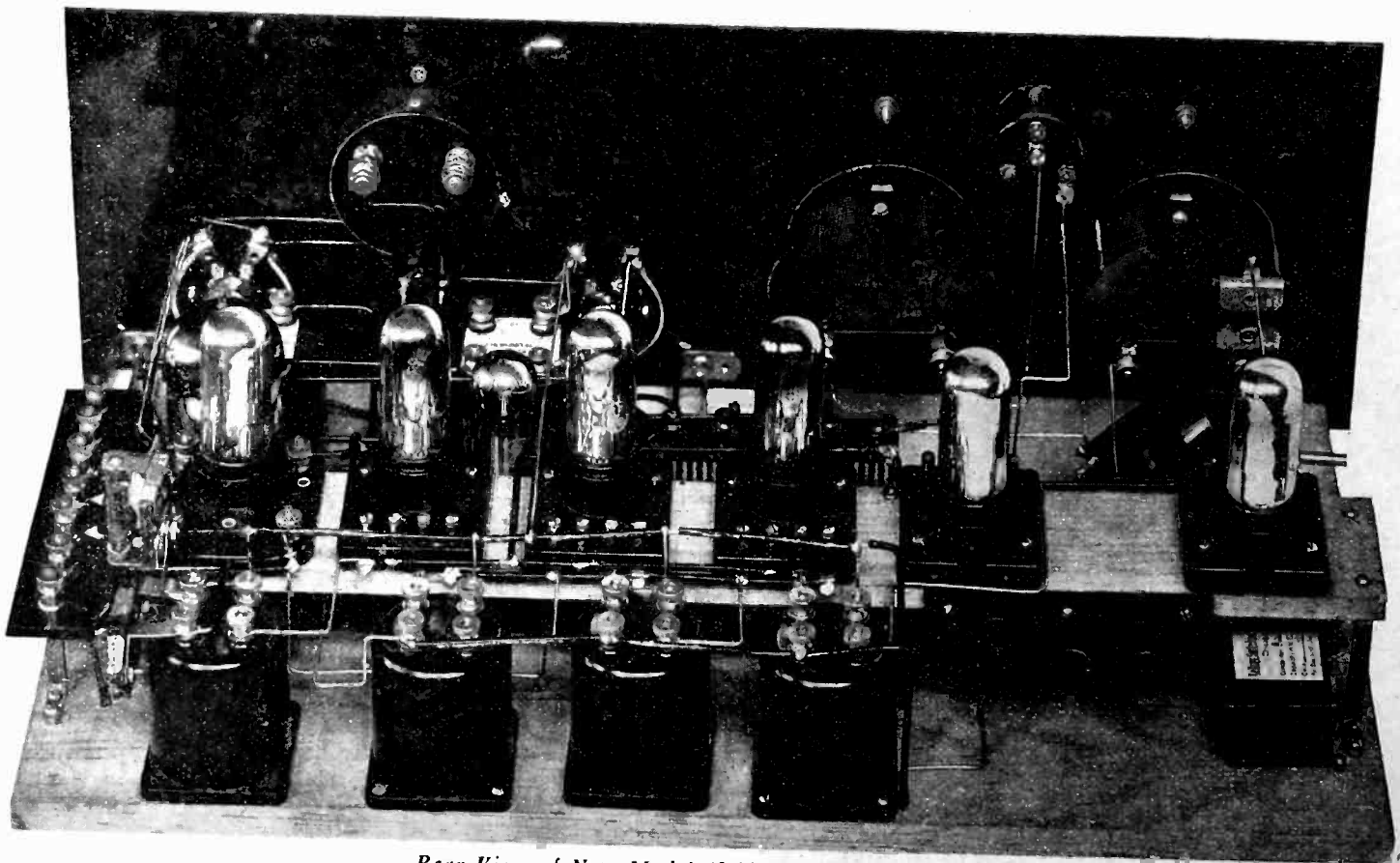

Rear View of New Model 45,000 Cycle Super-Heterodyne

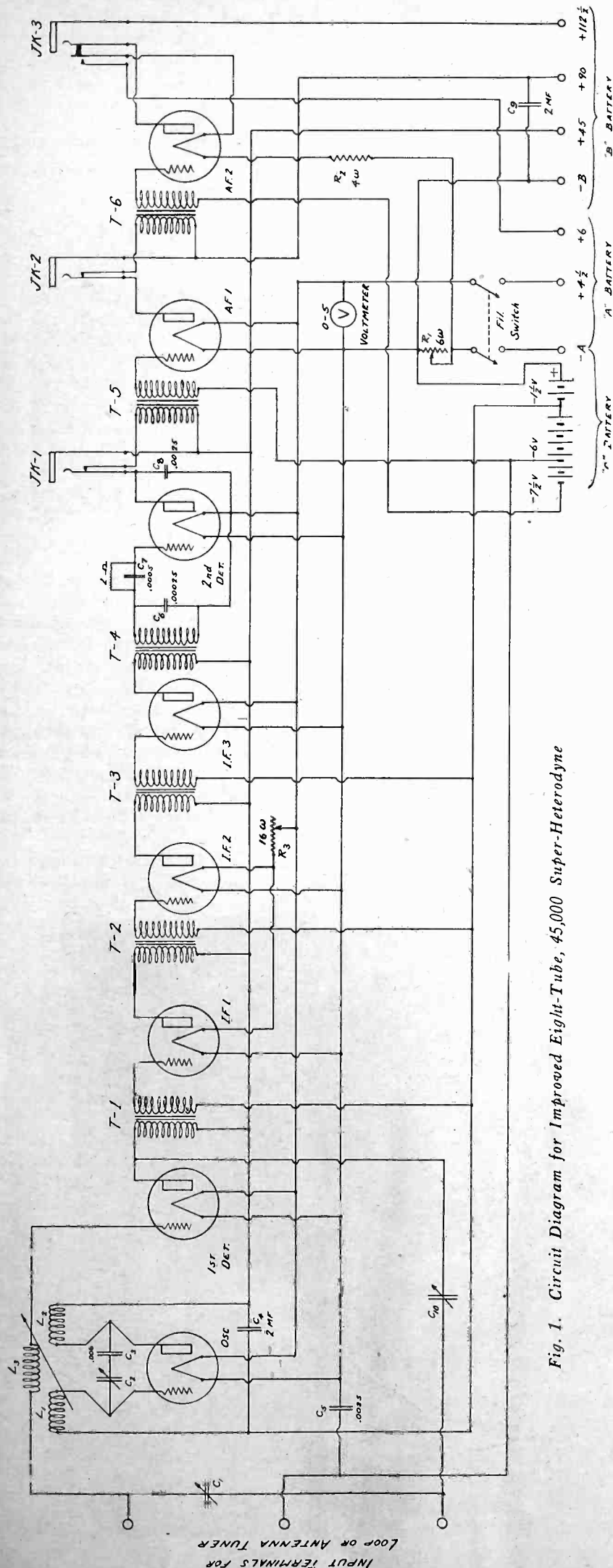

Fig. 1. Circuit Diagram for Improved Eight-Tube, 45,000 Super-Heterodyne

45,000 cycles above or below 1,000,000 cycles to produce a third frequency of 45,000 cycles. This frequency can then be amplified by three stages of transformer coupled amplification, finally passing into a second detector tube, where the voice or music superimposed on the carrier can be made audible, or further amplified by audio frequency stages.

In order to make the intermediate amplifier efficient at one frequency only, 45,000 cycles, it is necessary to tune the amplifier. To accomplish this, one of the transformers in the intermediate frequency amplifiers is tuned with a fixed condenser so as to be resonant at one frequency only, and all other frequencies are rejected before they can reach the second detector tube.

In other words, all the radio frequency amplification in the set is accomplished at one frequency, irrespective of the wavelength of the station being received. As a result, only two tuning controls are necessary, one for the loop antenna and one to control the oscillator tube. One-control superheterodynes have been designed, but they possess the disadvantage of being able to select only one point for the oscillator, for any given wavelength, whereas it is often very convenient to have the two settings of the oscillator, in order to avoid interference from other stations.

Theory of Circuit

FIG. 1 shows the schematic circuit diagram. It consists of four parts: (1) The local oscillator, for generating the second frequency, and the first detector, which receives the incoming frequency and mixes it with the locally generated frequency (marked *OSC* and *1st Det.* on circuit diagram); (2) Three stages of intermediate amplification, tuned to 45,000 cycles (marked *IF₁*, *IF₂*, *IF₃* on diagram); (3) The second detector which makes the signal audible (*2nd Det.*); (4) The audio frequency amplifier permitting the use of a loud speaker (*AF₁* and *AF₂*).

The set requires eight tubes, seven UV-199 or C-299 and one UV-201-A or C-301-A. The three stages of intermediate frequency amplification require four transformers which are efficient at 45,000 cycles, the fourth transformer (*T₄*) being of the tuned type, with an air core. The first, second and third transformers (*T₁*, *T₂*, *T₃*) are of the iron core type, with a flat frequency characteristic between 40,000 and 50,000 cycles. In the audio stages, a low ratio transformer of good frequency characteristic should be used, in order to deliver good quality of signal at the output of the set.

L_1, L_2, L_3 is the oscillator coil system, which consists of two similar windings on a $2\frac{1}{2}$ -in. fiber tube, with a third winding arranged on a smaller tube so that it can be varied with respect to the first two windings. C_1 and C_2 are variable air condensers for tuning the loop and oscillator coil respectively. C_3 is in series with C_2 to prevent an accidental short circuit in C_2 from damaging the tube filaments. It does not affect the tuning of C_2 . By-pass condensers C_4 and C_5 are used to localize the current in the oscillator and first detector circuits, the former also serving as a by-pass in the B battery circuit. These condensers should be mounted as close to the oscillator tube and coil as is possible, in order to prevent high frequency from getting into other parts of the set, with resultant broadness in tuning.

Condenser C_6 tunes the secondary of the last intermediate frequency transformer, which is of the air core type. C_7 is the grid condenser, and is shunted by a 2 megohm leak, although a high negative grid bias may be used instead of the grid condenser, if desired, as is done in the first detector tube.

In order to obtain stability of operation, and a reduction in noise, detection in the first detector is accomplished by biasing the grid with a 6-volt dry cell battery, so that the tube will operate at the bend in its plate current-grid voltage curve. The positive end of the 6-volt C battery is connected to the negative end of the filament, and the negative voltage is then fed through the loop and grid coil, to the grid of the tube. This procedure reduces the plate cur-

rent almost to zero, and causes the tube to present a high impedance to the loop circuit, thereby improving the selectivity of the loop.

it will not by-pass enough of the high frequency, and if it is above .003 mfd. it will tune the transformer to some audio frequency and spoil the quality of the signal. C_8 should be either 1 or 2 mfd., and is used to by-pass audio frequency across the 90-volt B battery.

It should be noted that three B battery voltages are used, 45, 90 and $112\frac{1}{2}$ volts. The negative end of the B battery is connected to the negative end of the filaments, between the tubes and the filament rheostat. This, in connection with C_9 , obviates any chance of burning out the filaments of the tubes due to short circuits in the B battery wiring.

The filament rheostat, R_1 , should be 6 ohm resistance, and is used to regulate the voltage of the seven C-299 or UV-199 tubes. The C-301-A or UV-201-A tube in the last stage is regulated by the self-adjusting resistance unit R_2 . The voltage regulation of the seven 3-volt tubes is indicated by a voltmeter, a necessity if tube life and battery economy is desired. The volume control rheostat, R_3 is 16 ohms, and is connected to the filaments of the first and second intermediate amplifiers. A Carter jack switch is used in the A and $+4\frac{1}{2}$ -volt leads, in order to open the filament circuits of both the 3 and 5-volt tubes.

It will be noted that no shielding is shown in the illustration, either on the

back of the panel or between groups of apparatus. Some shielding may be necessary if the receiver is close to a high powered station, or if troublesome power lines are nearby. The best material to use is either sheet copper or brass of sufficient thickness to stay in place when tacked to the interior of the cabinet. A partition may also be desirable to separate the oscillator and first detector circuits from the rest of the set. In that case, a rather heavy piece of brass will be necessary, holes being drilled to pass the leads connecting the apparatus on each side of the shield.

Jacks are provided for the detector and both audio frequency tubes, in order that any combination of tubes may be used. A filament control jack is used in the last stage so that the "A" tube may be cut out when not needed.

The loop circuit involves the use of a center tap, in order to improve the directional balance of the circuit, and permit a slight amount of regeneration by means of a small condenser, C_{10} , ranging in value from 1 to 15 micro-microfarads. This regeneration reduces the loop resistance, thereby increasing the selectivity as well as the signal strength. It is not absolutely necessary to the success of the circuit, however, and may be omitted if desired. One side of the loop goes to the grid coil in the oscillator circuit, and the other side to C_5 , while the center tap goes to the 6-volt tap on the C battery. The C battery should be in a central position, so that the leads from it will not be too long.

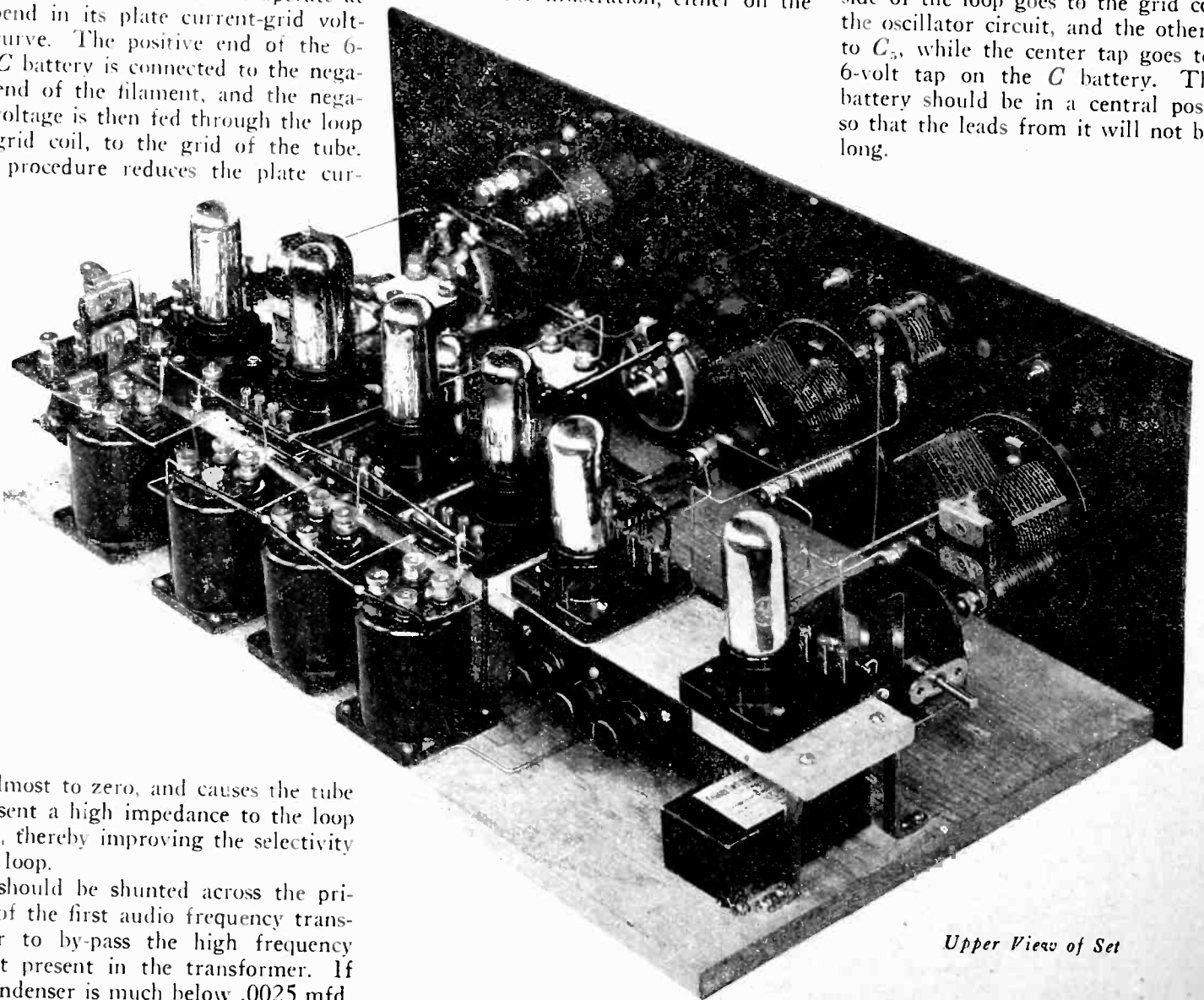

Upper View of Set

Description of Parts

THE accompanying table gives a complete list of parts as actually used in building the set here illustrated, together with a list of parts that might also be used. No specific recommendation for any of these parts is implied, the list being made up from those most generally available at radio stores. The panel and baseboard layouts are drawn for the parts actually used and should be modified to meet the dimensions of any alternative parts that may be used by those following these directions. There are undoubtedly other parts, not here listed, that will suffice. Using the most expensive parts listed, the total bill of material for the complete set will be about \$80, exclusive of vacuum tubes and batteries.

To facilitate laying out the panel drilling and the apparatus on the baseboard a full size drawing of the panel accompanies this article. Paste the tem-

plate on the panel, and with a center punch mark the centers of the holes directly through the paper.

The panel layout shows drillings for the parts given in the first list, and if other parts are used, the template will not be correct. The hole for the voltmeter, however, will fit either the Weston or Jewell voltmeter. Where flat head machine or wood screws are used the holes in the panel should be countersunk.

The intermediate frequency transformers should be such as to give good amplification at 45,000 cycles, and the input impedance of each primary should approximate the output impedance of the UV-199 or C-299 tubes, an important consideration. The iron core construction of the untuned stages limits the stray field and permits of close spacing, without shielding. The tuned transformer should be of the same type as used in the set here illustrated if it is

to operate with the fixed condenser specified in the circuit diagram. If another tuned transformer is used, it would be best to use a fixed condenser of the value specified by the manufacturer of the transformer in the circular accompanying the apparatus.

The audio frequency transformers, T_5 and T_6 , should have a low turns ratio, preferably not over 2:1, and a well constructed core with plenty of iron. The various fixed condensers should be of standard manufacture, and in the case of C_6 should be very accurate.

For providing the various negative grid potentials the Burgess No. 5,540 $7\frac{1}{2}$ -volt C battery is specified because it has enough taps to accomplish the desired results. The vacuum tube sockets should be of a good grade, and in the case of the second detector and audio stages, should be of the cushioned type, to avoid howling due to mechanical coupling between tubes.

PARTS FOR 45,000 CYCLE SUPER-HETERODYNE

No. Required	Part	Circuit Designation	Brand Used	Brands That Can Also Be Used
3	Untuned I. F. Transformer	T_1, T_2, T_3	Remler 600	All-American, Baldwin Pacific, Branston, Jefferson, Phoenix, Receptrad, Silver-Marshall.
1	Tuned I. F. Transformer	T_4	Remler 610	All-American, Baldwin Pacific, Branston, Jefferson, Phoenix, Receptrad, Silver-Marshall.
2	A. F. Transformer (2:1 ratio preferred)	T_5, T_6	Thordarson	Acme, All-American, Amertran, Coto, Dongan, Ford Mica, General Radio, Jefferson, Kellogg, Modern, N. Y. Coil, Peerless, Precise, Premier, Samson, Stromberg-Carlson.
2 1	Jack	JK_1, JK_2 JK_3	Federal 1422W Federal 1435W	Carter, Erla, Four-Way, Frost, Jones, Marco, Polymet, Saturn, Weston.
1	Oscillator-Coupler	L_1, L_2, L_3	Remler 631	Baldwin-Pacific, Branston, Phoenix, Receptrad, Silver-Marshall.
2	Rheostat	R_1 R_3	Federal 18 Federal 23	Allen-Bradley, Amsco, Carter, Central, Cutler-Hammer, Erla, Filko, General Instrument, Kellogg.
2	Variable Condenser	C_1, C_2	Remler 631	Acme, Allen-Bradley, American Brand, Bremer-Tully, Bruno, Cardwell, General Instrument, General Radio, Heath, Marco, National, Signal, Silver-Marshall, U. S. Tool.
1	Midget Condenser	C_{10}	Chelton 860	
5 2 1	Small Tube Socket Small Tube Socket Large Tube Socket	Cushioned Last A. F.	Remler 399 Benjamin Kellogg 2	Amsco, Chelsea, Cutler-Hammer, Frost, General Radio, Heath, Marco, Silver-Marshall.
1	Voltmeter	O-5	Weston 301	Jewell.
1	Jack Switch	Fil. SW.	Carter	Frost.
2 1 2 1 1	2 mfd. Fixed Condenser .006 " " " .0025 " " " .00025 " " " .0005 " " " With grid leak mntg.	C_3, C_6 C_5 C_8, C_8 C_6 C_7	Kellogg 62 N. Y. Coil N. Y. Coil Dubilier 640 Dubilier	Dubilier, N. Y. Coil. Dubilier Dubilier N. Y. Coil, Simplex Grid-denser.
1	Grid Leak	2 megohm		Allen-Bradley, Amsco, Burton, Central, Daven, Durham, Electrad, Filko, Freshman, Rogers, Turn-It. Wireless Products.
1	Controlling Resistance	R_2	Amperite 1-A	Cutler-Hammer 30 ohms, Allen-Bradley.
10	Binding Post	Terminals	Eby	Amsco, General Insulate, Marshal Gerken.
1	"C" Battery	$1\frac{1}{2}, 6, 7\frac{1}{2}$	Burgess 5540	Eveready.
1	Panel	$7 \times 20 \times 3/16$	Bakelite	Celeron, Pantasote, Radion, Spaulding.
1	Baseboard	$10 \times 19 \times \frac{1}{2}$		

The three-tap loop as illustrated has the dimensions given in Fig. 2. It is not necessary to use the exact type of loop shown. Several very good loops are now on the market, it usually being necessary with these to make an additional tap at the center of the loop to adapt it to the circuit. A swivel base is advisable so as to readily change the direction of the loop and take advantage of its directional properties. The loop should be wound with 12 turns of No.

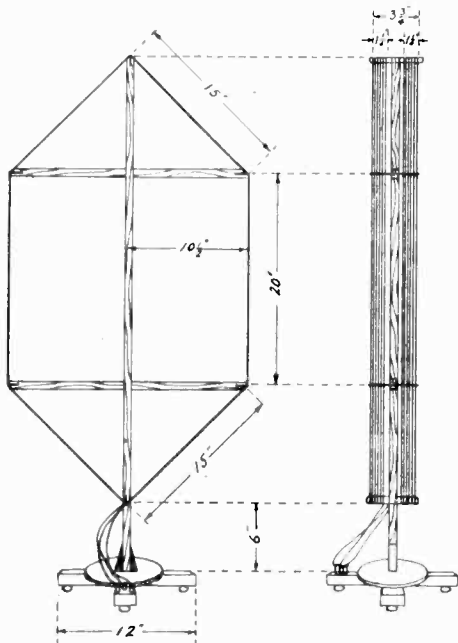

Fig. 2. Dimensional Drawing of Three-Tap Loop

18 lamp cord, or its equivalent. It is not necessary to use Litzendraht, as no advantage is to be gained at the radio cast wavelengths now used.

For those who wish to use an antenna with this outfit, the circuit diagram showing the additional apparatus needed is pictured in Fig. 3. The coupler con-

sists of a standard 180-degree vario-coupler, similar to the oscillator-coupler used in the receiving set. The antenna circuit should consist of a .0005 mfd. (23-plate) variable condenser, not necessarily of the vernier type, a 75-turn honeycomb or other compact inductance coil, and the rotor of the coupler. In order to prevent the reception of a large amount of noise, static and interference, it will be necessary to operate

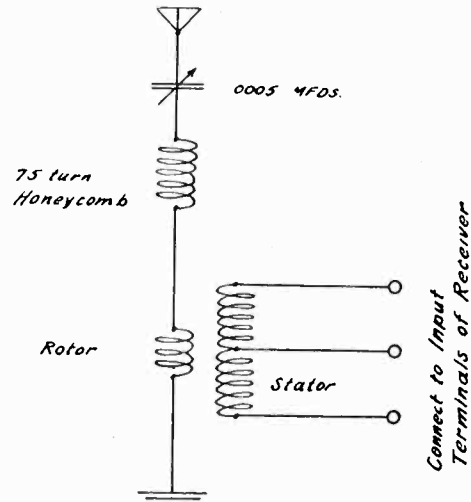

Fig. 3. Circuit Diagram of Antenna Adapter

the antenna coupler at minimum coupling, doing most of the tuning with the antenna series condenser. It would be well to shield the inside of the box containing the antenna tuner so as to increase the selectivity. Many have tried grounding one side of the loop antenna, with good results, although the directional properties of the loop will be somewhat impaired. However, for remote districts where local interference is not known, this would certainly improve the signal strength on distant stations.

Construction of Parts

MANY readers may desire to construct as much of the apparatus as is possible, and it is for their benefit that data on the construction of the oscillator coil and 45,000 cycle amplifying transformers are given.

The oscillator coil consists of 70 turns of No. 26 D. C. C. wire, wound in two sections of 35 turns each, on a 2 1/4-in. tube. The grid coil is 20 turns of No. 26 D. C. C. wire wound on a 1 5/8-in. tube, and arranged to rotate within the oscillator coil in a manner similar to the rotor of a 180-degree coupler. Pigtail leads should be used for the rotor connections.

The untuned transformers should be wound as follows: Turn out three hard-

Continued on Page 66

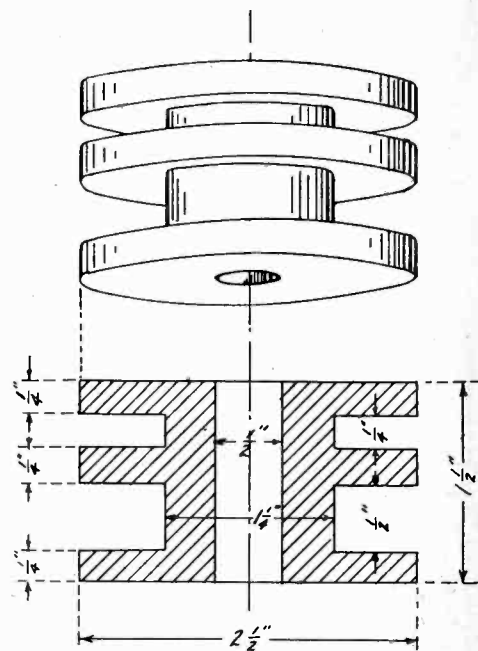
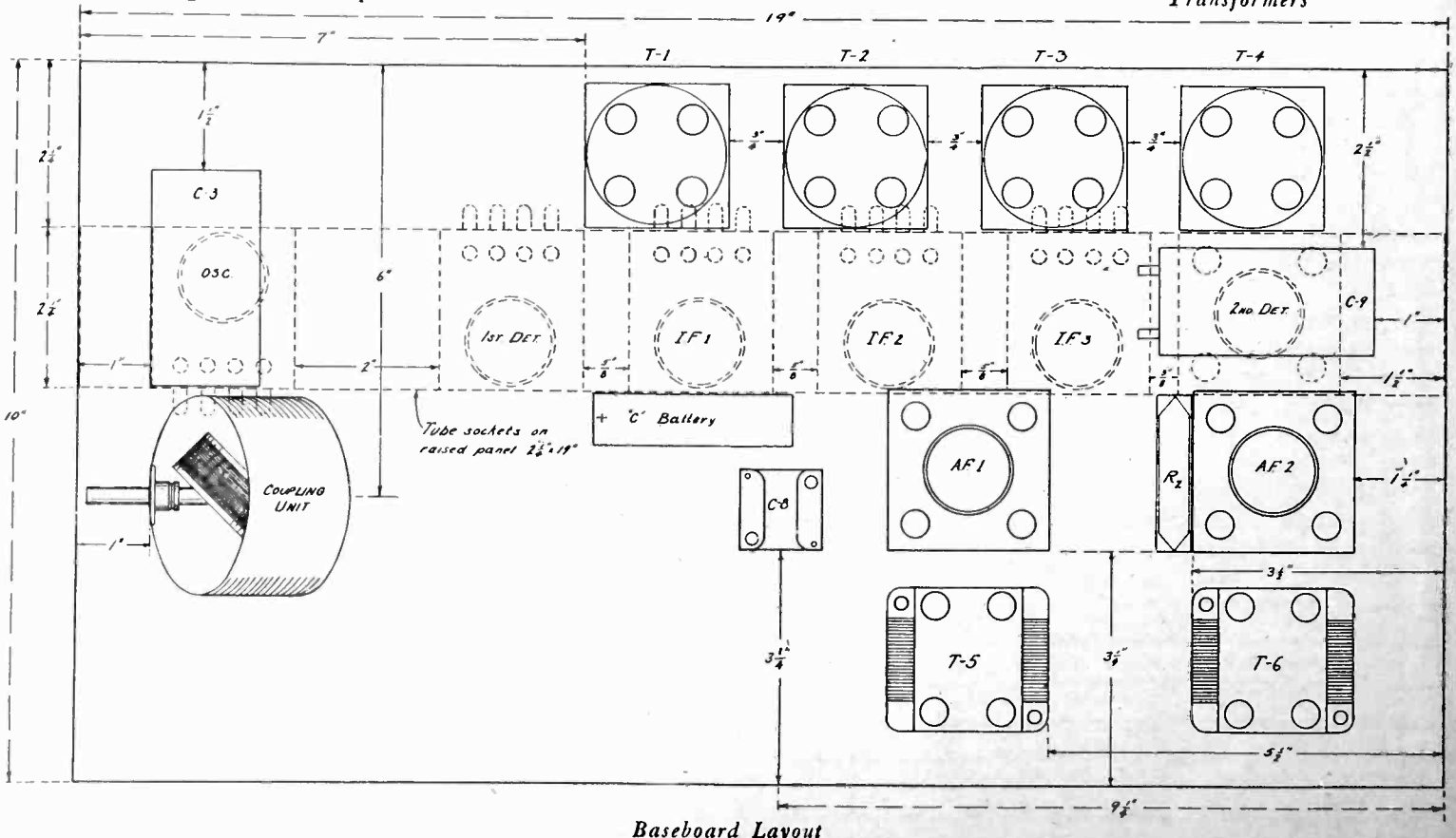

Fig. 4. Spool Dimensions for Untuned Transformers



Baseboard Layout

Round's Round Ground

Complete Directions for Constructing a Ground Connection That Will Materially Improve DX Reception

By Ferd Humphreys

THERE is no part of a radio receiving installation that is given less thought than the ground connection. This is probably because most of us think that one ground is practically as good as another and that when we have connected a metal wire to a metal pipe entering the earth all is well. Numerous experiments, however, have taught the radio investigator that there is a big difference between earth connections; that there are so-called grounds and real grounds.

While an efficient earth connection is of perhaps greater importance to transmission than to reception, due to the considerably larger amount of power handled, the value of an effective earth connection to reception should not be underestimated.

We have often heard that resistance is one of the greatest enemies to low loss reception. Low loss reception not only means strong signals from distant as well as local stations, but also selectivity and freedom from interference. In the interest of securing low loss operation we wind our tuning and coupling coils with heavy wire to minimize resistance, we construct our antenna of stranded wire and run a heavy wire from the receiver to a clamp on the water pipe for the same reason. But do we give adequate thought to that part of our receiving system supplied by Nature, the earth beneath the antenna, and to the connection thereto? In most cases we do not.

Let us consider, for a moment, the function of the ground and its relation to a receiver of any type. Aside from being the common medium which conductively binds together the transmitting and receiving stations, the earth beneath the antenna constitutes a large and important part of the antenna circuit. The antenna circuit consists essentially of the antenna, beginning at its outermost end, the down-lead or lead-in, the antenna-receiver coupling coil (primary coil of varicoupler), the ground wire, the earth electrode (water pipe) and the earth for a considerable area under the antenna.

When the waves transmitted by a radiocast station impinge on a receiving antenna, oscillating currents are induced in the antenna circuit which vary in intensity according to the power of the transmitter and its distance from the receiver and according to the characteristics of the circuit and the locality of the receiving station. Generally speak-

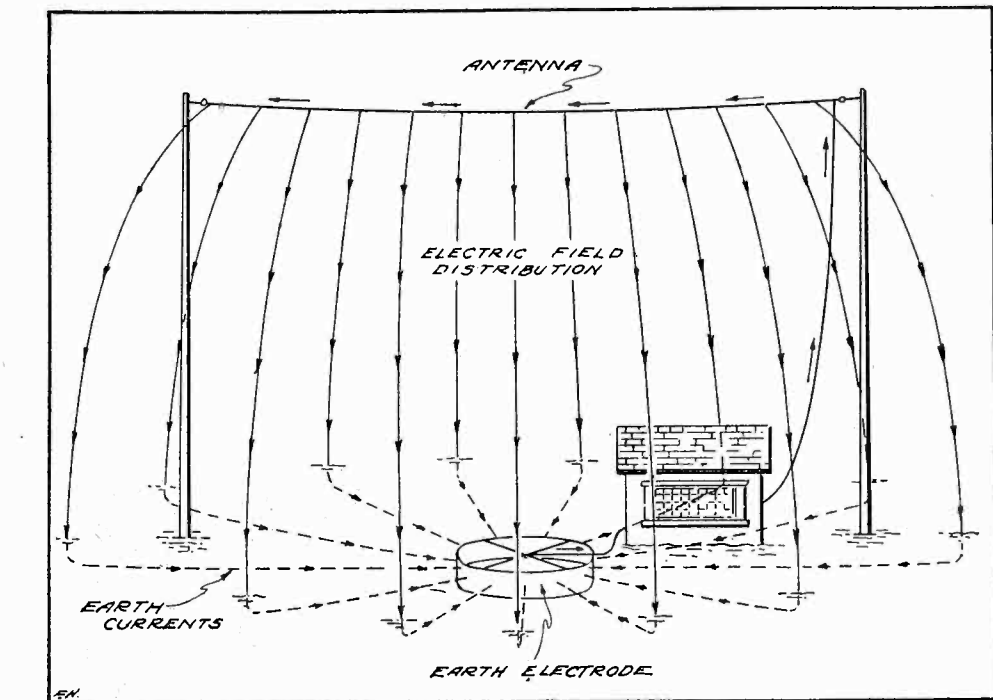

Fig. 1—Showing the relation of the earth electrode to the antenna circuit. Note the uniform distribution of earth currents.

ing, if the receiving antenna is high, well insulated, and of low resistance, reception from the desired station will be as good as the receiving instruments can permit. We cannot control the power of the radiocast station nor its distance from us and we cannot always alter local operating conditions, but we do often find it practicable to improve conditions which lie within our grasp. The ground is one of these.

The most common type of ground consists of the home water piping system. Although connection to the water system affords a fair ground because of the great buried length of water pipes, the system, as an earth electrode, is generally inefficient. That this is so is partially attributable to the fact that in very few cases does the water system lie under the antenna or anywhere near it. Hence, the oscillating currents induced in the earth beneath the antenna during reception or transmission, are compelled to travel far from the earth directly beneath it, where they might efficiently converge at a suitable electrode, to the nearest portion of the water system. To put it another way, we might say that the earth currents have to travel through too much earth to reach the electrode. Apart from the above disadvantage, the area of contact between the piping system and the earth, in the region of the antenna, is too small to permit of a good electrical connection. Since the conductivity of average soil is very poor as

compared to that of water pipe, which is none too good, it is obvious that the common ground just discussed must have a resistance too high to render it efficient.

Stuart Ballantine, a radio authority of recognized reliability, seems to be of the opinion that the most ideal earth electrode consists of a large metal cylinder of suitable proportions, buried in the earth beneath the antenna. The ground wire is made fast to the cylinder in a special way designed to give the best results. Such ground has recently been redescribed by Capt. H. J. Round, and is referred to in some circles as "Round's Round Ground." A better name would perhaps be the "Common Sense Ground," for it is older than radio itself, and was used by Fessenden as early as 1910, and was also described by the Germans prior to that time.

In modern times it has received its greatest support by the experiments of D. John M. Miller of the United States Navy Radio Laboratory.

Being compelled by virtue of circumstances to install an effective ground system for radio experimental work, I was inspired to try the "Common Sense Ground." It was decided to construct a galvanized-iron electrode 10 ft. in diameter by 2 ft. high, burying it 1 ft. beneath the surface of the earth.

The antenna, a 5-wire cage 60 ft. long by 65 ft. high, had already been erected, running east and west over an addition

to the house used as the experimental laboratory. The lead-in drops from the west end of the antenna to a lead-in insulator in the laboratory roof. Directly beneath the antenna and lead-in and at a point about 20 ft. east of the west end of the antenna, the center of the ground was located by driving a stake into the sod. With the aid of a piece of string provided with loops at the ends, a circular row of stakes was driven about the center stake at a radius of $5\frac{1}{2}$ ft. This was followed by an inner circle of stakes of 4 ft. radius. The stakes describing each circle were spaced about $2\frac{1}{2}$ ft. apart and were finally encompassed by wrapping them with string. A trench 3 ft. deep was then dug between the staked circles. This work required the removal of about 90 cu. ft. of earth.

Upon the completion of the trench the construction of the cylinder was undertaken. This was composed of 4

is done to prevent concentration of the earth's currents on the ground wires. In view of the unsightliness of such an arrangement and its liability to trip the trespasser, the writer decided to sacrifice this detail by burying the ground and its connecting wires completely. It was thought that what little current concentration might result from this practice could be reduced by using heavily insulated wire for connecting purposes. Accordingly, two narrow trenches 1 ft. deep were dug to join the diametrically opposite lugs of the four cylinder segments. A third trench of similar proportions was dug to accommodate the main ground wire, that which joins the cylinder wires and runs to the house. These trenches are shown in Fig. 2.

Two $10\frac{1}{2}$ ft. lengths of No. 8 braided rubber covered copper wire were then laid in the cross trenches and their ends soldered into the lugs. About 5

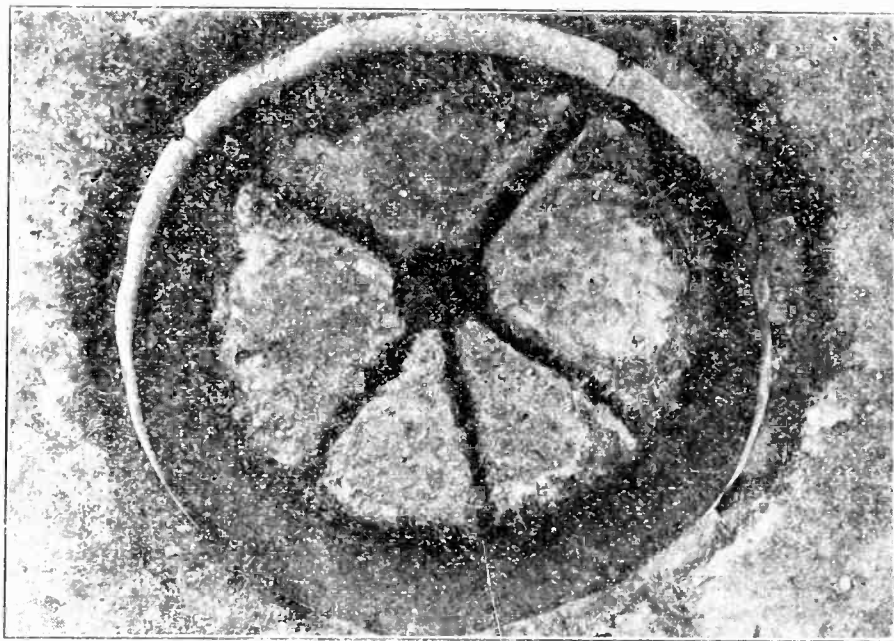

Fig. 2—Installation of the earth electrode.

pieces of $\frac{1}{64}$ in. galvanized-iron, measuring 8 ft. by 2 ft. The ends of the pieces were clinched and riveted with copper rivets. The seams were not soldered. Four $\frac{1}{8}$ in. copper soldering lugs were then secured with brass bolts and solder to the centers of the segments at the top of the cylinder. The lugs were mounted sleeve-up in order to facilitate soldering the ground wires later. The assembled electrode was next lowered into the trench where it was formed to a circle by packing a little earth at its foot around the outer side of the trench. The cylinder was then buried to within 6 in. of its top, care being taken during the process to maintain its circular shape.

At this point attention should be drawn to the difference of connection existing between this ground and the one described by Ballantine. His ground wires are elevated above the earth on a central supporting insulator while their outer ends make contact with the top of the electrode which is allowed to protrude above the earth's surface. This

in. of insulation was removed from these wires at their crossing point, followed by the removal of about 10 in. of insulation from the ground end of the main ground wire, which is of the same gauge and insulation as the cross wires. The main wire was then wrapped tightly about the cross wires and soldered. Several layers of rubber and friction tape were added to this union to exclude moisture and to minimize current concentration at this point. A coat of asphaltum varnish was also applied to the joint and to the lug connections to prevent corrosion, though this step was not really necessary. A porcelain tube was slipped over the main wire and taped in place at the point where the wire passes over the top of the cylinder. This was done to guard the insulation against rupture by pressure against the sharp edge of the cylinder occasioned by the earth packing, etc. The ground was completed by filling the trenches and pounding the loose soil with the back of a spade.

Fig. 1 shows the relation of the

ground to the antenna. Here it is obvious that a uniform distribution of earth current is obtained over the entire surface of the electrode, due to its location within the field of the antenna and to its shape and generous surface. The current is drawn from the electrode by means of taps which have been so arranged as to lower the effective resistance of the galvanized-iron. Location of the electrode within the natural field of the antenna has the effect of shortening the average distance to be traveled by the earth currents, as against that of the water system, thereby lowering the effective resistance of the earth to a minimum. All things considered, it must be admitted that theoretically this is an ideal ground. The ground was next tested for practical worth.

Despite the shallow depth at which the electrode was buried for operation at the longer wavelengths of the broadcast band, distant and local broadcast stations are received unusually well. With an ultra-audion regenerative receiver employing a single stage of audio amplification it is possible to pick up stations which with an ordinary pipe ground are inaudible. The antenna circuit also possesses real selectivity, owing to its low resistance. Transmission experiments at short wavelengths (100 to 200 meters) and at low power (10 watts) have shown the electrode to be very effective for amateur communication. The writer is well pleased with the results of his labors and highly recommends "Round's Round Ground" to the enthusiast who wants a real ground system.

Silent Voices

By REID DAVIES

That day is not, in time, so distant when
Vast Silence spread its mantle o'er the
world,
Chill Loneliness besieged the lives of men,
And oft the wings of dark Despair were
furled.

But, lo! a wond'rous miracle appears;
Where Silence spread its robe, a sweet
voice sings;
The pall of Loneliness is drowned in cheers,
And at the sound Despair unfolds its
wings.

The lonely traveler on desert sands,
Outrivaling Aladdin's magic lamp,
Can almost feel the clasp of friendly hands,
As from the air bright laughter fills his
camp.

To starving souls, condemned their lives to
live
Within the Shadow of Eternal Night,
The lamp sublime companionship can give,
And 'round them shed its auditory light.

The watcher on some evening mountain peak,
As starry echoes fly across the years,
May later learn to make these echoes speak
In accents and in music of the spheres.

Or as, alone in dark primeval wood,
The presence of some loved one seems to
tread,
The living, when the way is understood,
May yet tune in the message of the dead.

Some Novel Ideas in Receiver Construction

Complete Data for the Construction of a Non-radiating Receiver Combining Portability, Stability and Selectivity, at a Minimum Cost

By E. E. Griffin

THE constructional difficulties encountered in building multi-tube receivers often times limits the homemade set to one, two and three tube regenerative outfits, the merits and shortcomings of which are too well known to be discussed here. The set described in this article eliminates most of the shortcomings, possesses additional merits over the straight regenerative outfit, and at the same time does not entail much further structural complications. It is quite flexible in operation, tuning can be done by the heterodyne or squeal method if desired without interfering by radiation, it can be used without antenna, can be easily taken in a car for outing trips, and will also perform satisfactorily on any size of antenna without switching or changes in wiring and with only slight change in tuning.

The retail cost of complete parts necessary in the construction should not total over eighty dollars, including cabinet, tubes, batteries and loud speaker. The parts necessary are:

- | | |
|---|--|
| Cabinet | 4 UV-199 or C-299 |
| Panel, 7x21 in. | tubes |
| Baseboard, 5½x19½ | .001 mfd. fixed condensers |
| Loud Speaker | 1 10-ohm rheostat |
| 4 tube sockets | 1 variable grid leak |
| 90-volt B battery | 1 .00025 mfd. fixed condenser |
| 6 No. 6 dry cells | 1 battery switch |
| 1 4½-volt C battery, with 3-volt tap | 100 ft. wire (for loop) |
| 2 audio frequency transformers, 3¼ to 1 | 3 large binding posts |
| 2 23-plate variable condensers, Vernier | 1 piece tubing, 3½ in. diam. by 2¼ in. long |
| 1 variable condenser, .000045 mfd. maximum capacity, Chelton Midget or 3-plate standard size. | 1 piece tubing, 2¾ in. diam. by 1½ in. long with shaft |
| | 2 lengths pigtail wire, bus wire, spaghetti, etc. |

The cabinet can be made of any hard wood, complete dimensions being given in Fig. 3. All material is ½ in. stock except the 1-in. strips which should be of the same thickness as the panel. An 8-in. width of the top is hinged to permit of tube inspection and battery re-backed with a thin piece of silk of a newing. The front latticed opening is backed with a thin piece of silk of a color to match the finish of the wood-

work. To facilitate removing of the two lower panels, a ½-in. strip is fastened back of the lower 1-in. piece, on which the panels slide. The right-hand vertical 1-in. strip is backed by another ½-in. strip so that the inner side is flush. The solid panel is slightly smaller than the open panel. The open panel is inserted first in the right-hand side, by slightly turning, then brought forward to rest on the ½-in strip, and push-

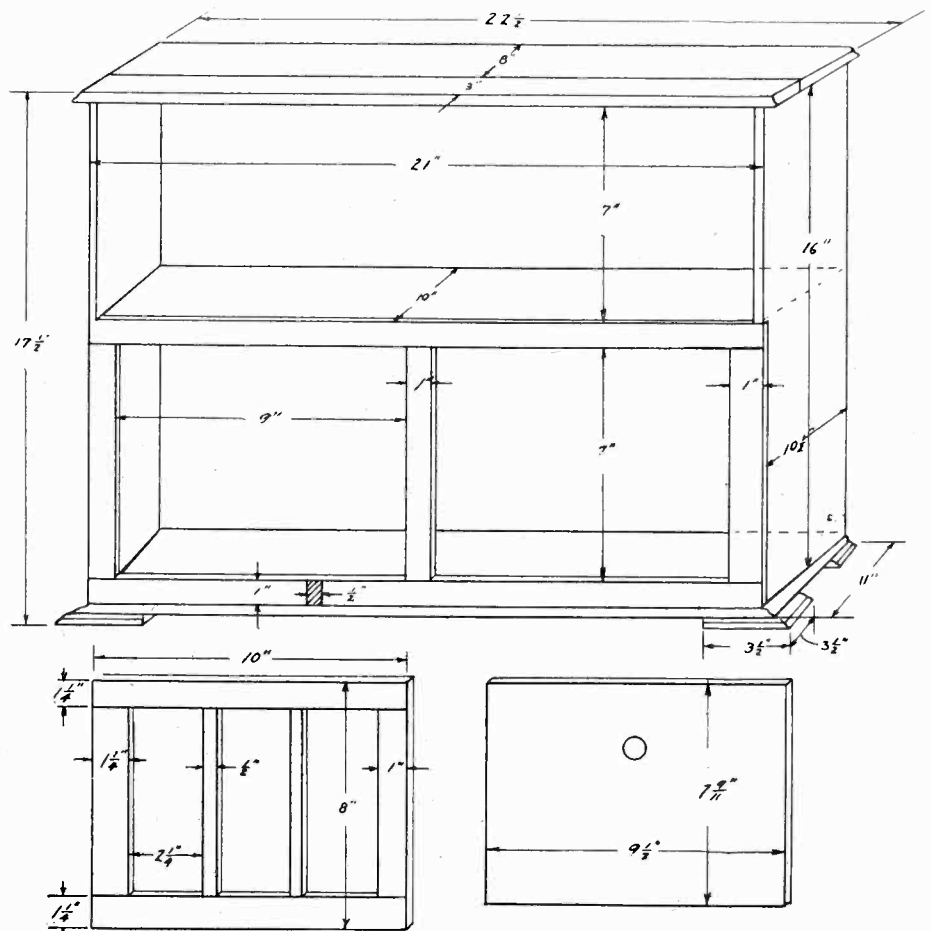

Fig. 3. Details of Cabinet Construction

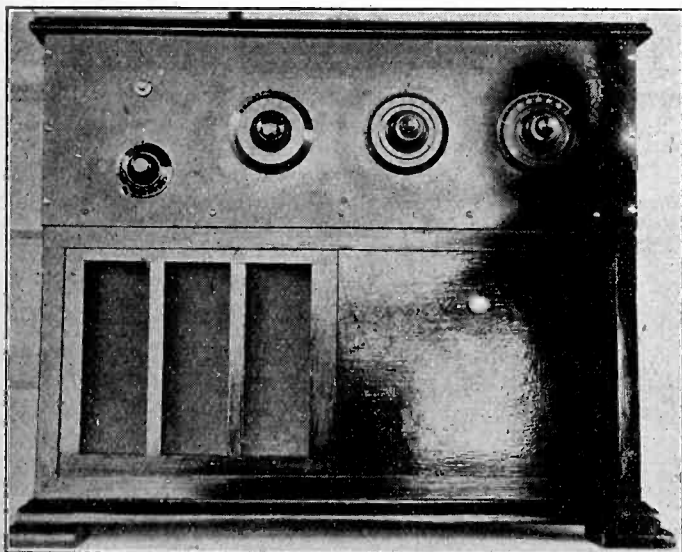

Fig. 1. Complete Four-Tube Set With Loud Speaker and Batteries

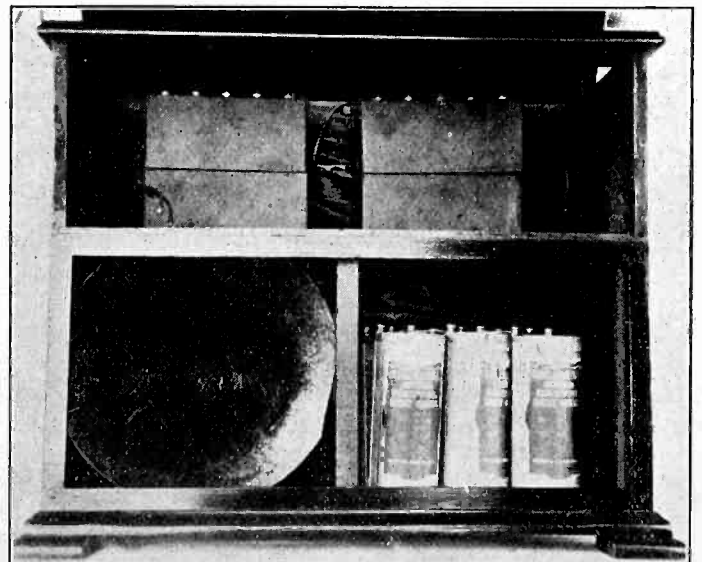

Fig. 2. Cabinet Without Panels, Showing Loud Speaker, Batteries and Loop Leads

ed over to the left. The solid panel is inserted by its upper edge first, pulling upward until the lower edge clears, then dropped into place. A small wooden stop on the right-hand side prevents this panel from falling inward when placed. To remove, the panel is pushed upward, the bottom then clears the lower strip, and the panel is lowered out. For those who do not care to construct a cabinet, one of almost similar dimensions can be obtained from supply houses at a nominal cost.

The panel is 7 in. by 21 in. and preferably $\frac{3}{16}$ in. thick, although a thinner one may be used, as sufficient strength is given it by the baseboard. The baseboard, fastened to the lower edge of the panel, is $5\frac{1}{2}$ in. by 19 in., and $\frac{1}{2}$ in. thick, of any soft wood. This size permits of sufficient clearance in the back of cabinet for the placing of *B* batteries and still does not crowd the instruments. Drilling dimensions of the panel are given in Fig. 7.

Any good loud speaker that does not measure over $22\frac{1}{2}$ in. total length and with a bell not over 10 in. in diameter will suffice. The bell is squared slightly to fit the lower compartment of the cabinet. There are several popular makes on the market that, with the base removed, are quite suitable. The horn is placed on its side, with the unit end extending back of the *A* batteries, as in Fig. 2.

It is best to first drill and fit the panel accurately to the cabinet, then remove and fit baseboard, mount the condensers, rheostat and battery switch, so that proper spacing of transformers, *C* battery, coupler and sockets may be determined.

The audio frequency transformers are placed at right angles to each other to reduce intercoupling, and the .001 mfd. bypass condenser is mounted directly on the primary terminals of the first transformer.

The four soft rubber base sockets are placed in line at the extreme back of the baseboard with their negative terminals all to the rear, Fig. 4. In this manner two straight leads can be used to connect all filaments, and the grid and plate wiring is simplified.

The grid condenser of the detector is

preferably mounted directly on the grid post, and the lead to the variable grid leak is made as short as possible. The small balancing condenser may also be mounted directly on the grid post of the radio frequency tube socket, making connection from the stationary plates of this condenser to the grid. This condenser should have a maximum capacity of .000045 mfd. and in this regard a Chelton Midget Vernier serves admirably, although a three-plate condenser of standard sized plates will give the required capacity variation. A small binding post connecting to the grid of the radio frequency tube and the stationary plates of this condenser serves as a connection for one side of the loop.

The other, or ground side of the loop, is brought through a .001 mfd. condenser to the negative post of the last tube socket. A connection is also made from this end of the loop to the 3-volt tap of the *C* battery and the rotary plates of condenser C_2 . This gives a radio frequency bypass, and puts a negative 3-volt bias on the grid of the radio frequency tube with its resultant saving of *B* battery current.

The coupler is preferably home-constructed. A $2\frac{1}{4}$ in. length of $3\frac{1}{2}$ in. tubing is wound with 56 turns of No. 24 DSC wire, with a tap taken off at the 40th turn. The rotating coil is a $1\frac{1}{2}$ in. length of $2\frac{3}{4}$ in. tubing wound with 30 turns of the same size wire, and fitted with a shaft and bushing to which the regeneration dial is attached when secured to the panel. This winding may be split to allow center clearance for the shaft, in which case it will be necessary to wind in double layers. The 56 turn coil is mounted with the tapped end at the bottom the lead from the plate of the radio frequency tube and grid condenser being connected to the top; the rotary plates of C_1 and C_3 being connected to the bottom. A 10-in. length of flexible lead is soldered to the tap and used to connect to the $67\frac{1}{2}$ -volt *B* battery terminal when the instrument board is placed into the cabinet. The regeneration coil must be rotatable through 180 degrees and can be connected to the detector plate and the first audio frequency transformer by flexible leading. In this regard,

stranded pigtail wire covered with the more flexible grade of spaghetti is excellent.

If a coupler is purchased, it should conform as closely as possible to the dimensions given, in order to maintain good stability of regeneration adjustment and minimize coupling in relation to the loop on the back of cabinet. The popular form of angle mounting, or 180-degree coupler should not be used for the last reason.

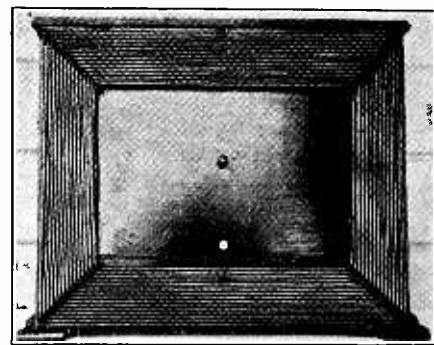

Fig. 5. Back of Cabinet With Loop, Showing Three Binding Posts for Various Antenna Combinations

Audio frequency transformers of any standard make can be used, but preferably those of low ratio for both stages to prevent distortion. Lengths of flexible leading are used for all terminals connecting to *A* and *B* batteries, small holes being placed through the center shelf of the cabinet to permit passage of loud speaker and *A* battery leads.

The loop is wound on the back of the cabinet and held in place by four hard rubber supports mounted on small brass angles. The supports are $5\frac{1}{2}$ in. long by $\frac{3}{4}$ in. wide, holes being drilled $\frac{3}{8}$ in. apart for the 16 turns of the loop. Referring to Fig. 5 the loop is wound by beginning with the inside hole of the upper right-hand support, a sufficient end being left to connect thru the cabinet to the .001 mfd. bypass condenser and *C* battery. Stranded rubber covered single conductor lamp cord is recommended, but if solid wire is used, it should not be smaller than No. 18. A length of lead is also connected at this point and run to the lower binding post *G*, which is used for ground connection. After winding $3\frac{1}{2}$ turns of the loop a tap taken off and run to binding post *L*, which serves for a long antenna connection (the post in the center of the cabinet). The remaining turns are wound ending at the upper left-hand support at the outside hole where sufficient lead is left to connect to the balancing condenser. A short lead is also taken off at this point of entrance to the cabinet and run to post *S* for connection to an extremely short antenna.

The size and shape of the cabinet permits of the loop arrangement and makes the set a complete unit, capable of operation with or without antenna and ground, and is completely portable. However, if these features are not desired and a smaller cabinet is used, the

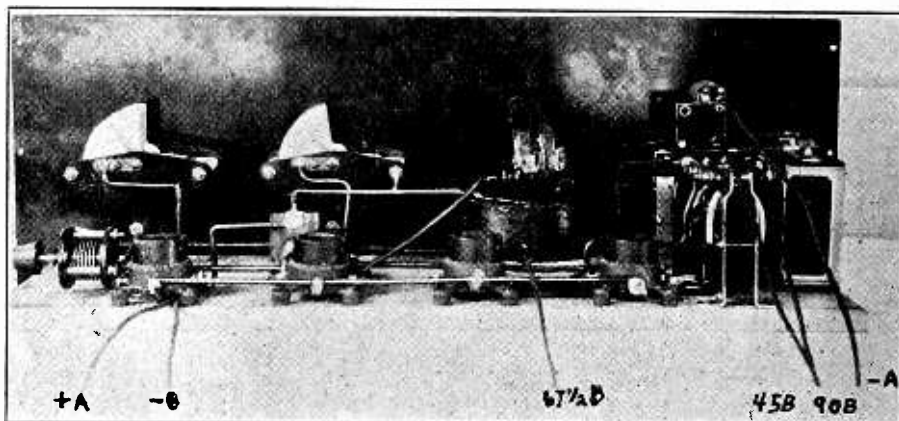

Fig. 4. Instrument Wiring

Commercial Testing of a Regenerative Set

A Brief Account of The Routine Employed by a Large Manufacturer of Factory Built Receivers

By H. Diamond

Department of Electrical Engineering, Lehigh University

IF it can be said that there is any standard radio circuit, the ordinary well-designed regenerative set is the closest approach to it. It is quite true that regeneration has its faults. But for simplicity, dependability, ease of construction and comparative detecting efficiency, it is a most satisfactory hook-up. When properly designed a one-tube regenerative set will give results at least as good as a straight detector with two stages of audio-frequency amplification. When properly operated, at a point just below oscillation, there is no reason at all why its worst feature, radiation, need occur.

Before condemning the regenerative circuit, it should be remembered that radiation also occurs with reflex sets, improperly neutralized neutrodyne sets, or with sets using radio-frequency amplification with rheostat control. It is the purpose of this article to describe the rigid tests applied to a typical regenerative set and to show that with proper care it is possible to use a set of this type efficiently and without radiation.

The most general type of regenerative set consists usually of four portions: (1) the tuning system, (2) the radio-frequency amplifier, (3) the detector, and (4) the audio-frequency amplifier. The tuning system comprises coils, condensers or a combination of these elements, one of which is variable, so that the system, including the antenna or loop, may be tuned to the high frequency of the incoming wave. To the radio-frequency amplifying system is assigned the task of amplifying the incoming signal to a point at least above the critical strength necessary to operate the detector. The detecting system consists of a rectifying device, either a crystal or a vacuum tube, which converts the amplified radio-frequency signal to an audible-frequency. This is then further amplified by the audio-frequency amplifier. The tests performed are therefore treated under the above four headings.

Fig. 1 shows the general test set-up. A calibrated buzzer-driven wavemeter is used as the source of radio-frequency signals. By varying the setting of the wavemeter condenser signals of any desired frequency may be obtained. The pick-up coil, consisting of two or three turns of wire, is very loosely coupled to the coil of the wavemeter and is connected through an artificial antenna to the "antenna" and "ground" binding posts of the set under test. The artificial antenna is merely a circuit having lumped values of resistance and capacity simulating the distributed values in an actual antenna. Since the inductance of

units, preliminary tests are made on each component part. These may include measuring the actual range of inductances, capacities, etc., and checking with the required values; and also tests for short circuits, improper winding, poor assembly or defective insulation. After the parts are assembled, the wiring is checked against the proper wiring diagram. The set is then thoroughly inspected to insure good soldering, sufficient clearance between conductors and smooth rotation of moving parts.

The set is now connected according to the standard test set-up of Fig. 1 and the wavelength range of the tuning unit

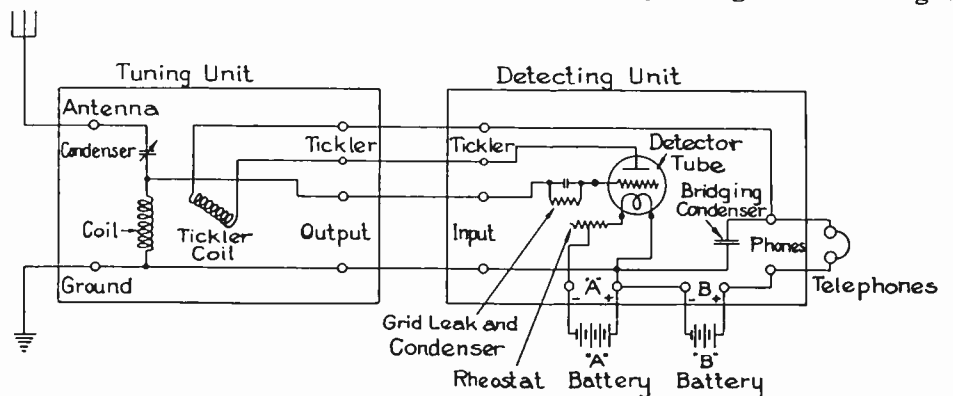

Fig. 2. Diagram of Parts in Single Circuit Regenerative Set.

an actual antenna is usually very small, a lumped inductance is not necessary.

The leads from the pick-up coil to the artificial antenna are made extra long to prevent electromagnetic or electrostatic coupling directly from the wavemeter to the receiving set. An excellent check that no such coupling is obtained may be had by disconnecting the pick-up coil. No signals from the wavemeter should then be heard in the receiving set.

For each test there is also provided a standard unit similar to the unit under test, and which by a "throw-over" system of connections may be substituted for the test unit. A direct comparison may therefore be made.

Prior to the assembly of the various

checked against the range specified. The test specifications give not only the wavelength range but also the capacity range of the antennas for which this wavelength range is guaranteed. This arises from the fact that it is difficult to tune a set down to its minimum wavelength on a large capacity antenna or to tune it up to its maximum wavelength on a small capacity antenna.

In making the test, therefore, the wavemeter is set at the specified minimum wavelength and the artificial antenna adjusted to the specified maximum value of capacity. The tuning unit is then adjusted for maximum strength of signal in the phones. Using the "throw-over" method a direct comparison is then made with a standard tuning unit, an equal signal strength indicating that the minimum value of wavelength is possible with the tuning unit in question.

Similarly, the wavemeter is set at the specified maximum wavelength, the artificial antenna capacity adjusted to the specified minimum value and the test repeated.

THE tests made on a vacuum tube detecting unit consists of a detection test and an oscillation test. In Fig. 2 is shown a detecting unit used with a

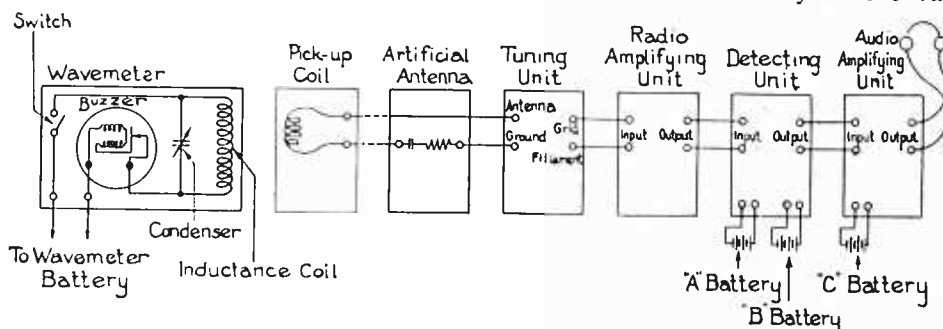

Fig. 1. General Test Set-up.

tuning unit, the two together constituting a single-circuit regenerative set. A potentiometer is sometimes connected across the filament battery, the return of the plate circuit being made to the moving contact of the potentiometer, a finer adjustment of plate-battery voltage being thus effected. This modification is shown in Fig. 3.

In detection test, the tickler coil (shown in Figs. 2 and 3) should be kept at its minimum value to avoid regeneration. The tuning system is tuned to the wavelength of the driver wavemeter and the strength of the signals in the telephones compared with those obtained when using a standard detecting unit. This comparison should be made for several wavemeter settings.

The purpose of the oscillation test will best be brought out from a consideration of the theory of regeneration. As the coupling of the tickler coil is increased, more and more energy is returned to the grid circuit and then fed back through the tube, being thus greatly amplified. The coupling may be increased to a point, however, where the feeding-back process throws the tube into violent oscillations. It is then that radiation occurs. Fortunately, regeneration occurs just before oscillation, and it is at this point that the set should be operated for maximum efficiency.

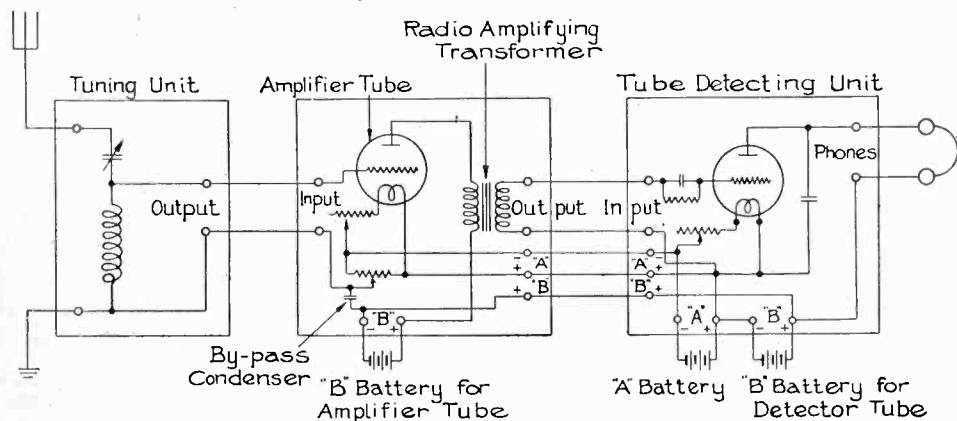

Fig. 4. One stage Radio Frequency Amplifier With Detector.

For some fans there is a temptation to seek stations by making the tube oscillate, the stations being then located by the characteristic whistles resulting from "beating" them with the local oscillations. After the station is located the filament is turned down to a point just below oscillation and the final adjustments for good reception made. This method shows very little consideration for the neighbors, however. With a little experience, stations can just as readily be located and tuned in without making the tube oscillate.

The oscillation test, then, must show two things: (1) That it is possible to make the set oscillate throughout its entire wavelength range. (This makes certain that the point of regeneration, just below oscillation, can be obtained throughout), and (2) that the set may be prevented from oscillating throughout its entire wavelength range.

ing the characteristic tone of the incoming signals is a good indication that the tube is oscillating.

(b) The artificial antenna capacity is reduced to the specified minimum value and all the antenna resistance cut out. The tuning unit is adjusted to its minimum possible wavelength, the tickler coil being arranged for minimum coup-

ling. Under these conditions, the set should not oscillate.

FIG. 4 shows a radio-frequency amplifying unit used together with a tuning unit and a detecting unit. It will be noted that the tickler coil has been removed since the adjustments necessary to make regeneration and radio-frequency amplification occur at the same time are too critical. A potentiometer is connected across the A battery of the amplifier tube, the return from the grid of the amplifier tube being connected to the moving contact of this potentiometer. As the potentiometer contact is moved from the positive side to the negative side of the battery, amplification increases until a point is reached when the tube is forced into oscillation. The point of maximum amplification is just short of oscillation. (The marked similarity to a regenerative tuner should be noted).

The tests made on a radio-frequency amplifier consist of an amplification test and an oscillation test. In the amplification test, the moving contact of the potentiometer is brought to the positive side of the A battery and the coupling between the pick-up coil and the wavemeter coil is made sufficiently loose so that the signal is just audible. The results are then compared with those obtained from a standard under the same conditions and should be identical.

In the oscillation test, with the same coupling as above, the potentiometer contact is moved from the positive to the negative side of the battery and the increase in signal strength is noted until

Continued on Page 64

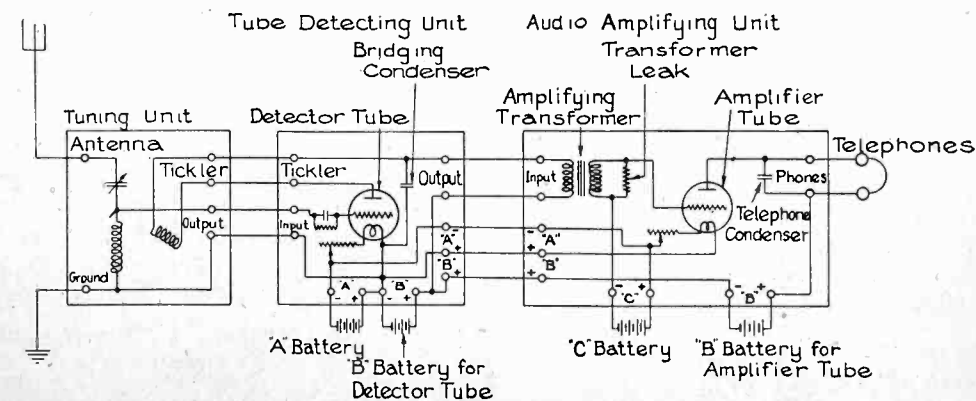

Fig. 5. Audio Frequency Amplifier.

MAKING THE SINGLE CIRCUIT SELECTIVE

By HENRY A. NICKERSON

As a single circuit regenerative set is frequently unable, in these days of high power broadcasters, to cut them out, its selectivity may be improved by a change in hook-up as follows:

1. By shunting the tuning inductance with the variable condenser and the insertion of a small fixed (or variable) condenser in the antenna lead (Fig. 1).

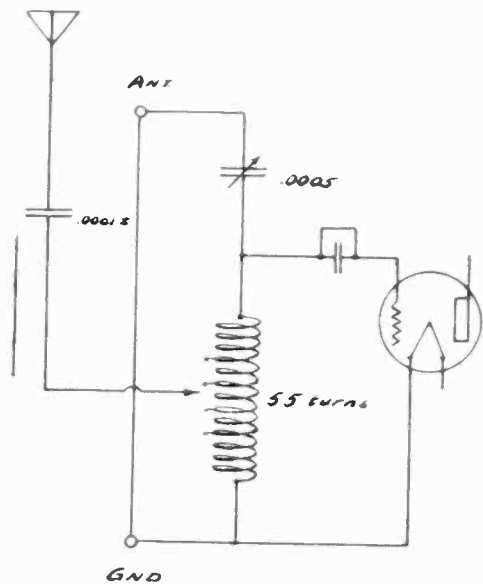

Fig. 1. Improving Selectivity by Putting Condenser in Antenna Lead.

2. By adding an untuned primary (or untuned primary with load coil) to the single circuit (Fig. 2).

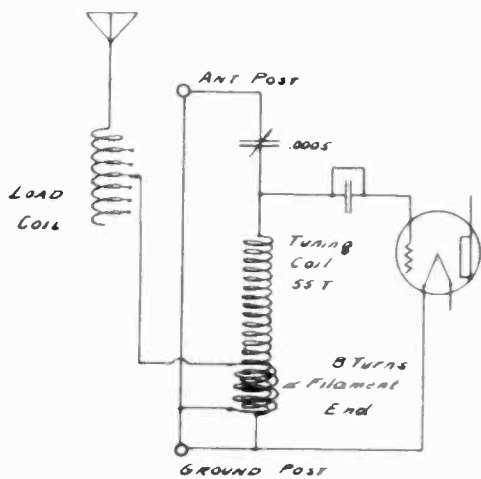

Fig. 2. Improving Selectivity by Adding Untuned Primary.

The diagrams are in a sense self explanatory.

In Fig. 1, the antenna and ground posts of the usual single circuit are "short-circuited" by a piece of wire, and the antenna lead is brought to one terminal of a .0001 mfd. fixed condenser, the other side of the condenser being connected to the switch arm. If the bearing of the switch lever is connected to a panel "grounded" shield, the shield must be cut away around the bearing. When the lever is placed on the tap at the grid end of the tuning coil in

Fig. 1, we practically have the same old single circuit, but when placed on a tap nearer the filament end of the tuning coil, we have in effect a double circuit tuner. Trial of various taps is necessary to find which gives the greatest volume coupled with selectivity, the fewer turns in the "untuned primary" the greater the selectivity (with less volume) as a rule.

Fig. 2 indicates what is now a common tuning device in many of the multitube sets, such as the various types of neutrodynes, where an untuned primary is wound at the filament end of the coil of 55 turns more or less, which constitute the secondary, the 55 turns being shunted with a .0005 mfd. variable condenser. The number of turns in the secondary must be such that it will cover 220 to 550 meters or else the number must be increased or diminished to reach the desired limit either way.

The load coil may consist of 50 to 75 turns wound on a tube or spiderweb, with taps every ten turns or so. It should be placed so its axis is at right angles to the tuning inductance and 6 inches or so distant. As a rule the adjustment of the load coil is not very critical and is made for a particular antenna and left that way. If it is desired to make an untapped coil to take the place of a tapped coil, it should be remembered that if, say 30 turns on the tapped coil work best, where there are 50 or more turns in the whole coil, the use of slightly more than 30 turns in an untapped coil will be necessary to get the same results.

One should not expect, even with a good antenna and ground system, a smooth-working regeneration control. Neither of these changes completely eliminate powerful local interference. But selectivity may be greatly increased and the single-circuit saved from the scrap heap by making these simple changes.

LETTERS OF A DEEP SEA "OP"

Illustrating a System for Using One Antenna for Simultaneous Reception On Different Wavelengths.

S. S. Jest Wester,
Manila, P. I.

Dear Jack:

Do you remember the three-tube, radio frequency, reflex, regenerative outfit I told you about last trip? Well, she perks beautifully; dragged in Chicago a couple thousand west of Frisco, but the blamed thing let me in for a lot of extra work until I put the old bean to going on its elimination. The gang all got accustomed to a nightly orgy of bedtime stories, music, etc., and howled to high heaven when I shut her off to listen on the 600-meter wave. The

old man is nuts for weather reports and unless he gets the 8 p. m. position and weather of every ship for a thousand miles around, he also lets go a mighty howl.

So being, there was only one way out of it to keep them all happy. I used the ship's antenna and receiver for the 600-meter stuff and strung up a single wire auxiliary antenna for the broadcasters. This was fine biz at sea but in port the single wire was in the way of the cargo booms and had to come down. Now, a hundred feet or so of stiff, dirty antenna wire is a nasty mess to handle and being a confirmed enemy of work anyway, I decided it was all wrong.

They say curiosity killed the cat, and in this case it certainly killed the work. Through curiosity, I hooked the broadcast receiver antenna connection to a .0001 mfd. Micadon and hooked that in turn to the main antenna. It works fine, and strange to say, there is no interference between the two receivers even though they are blooping. Tuning one does not affect the other and the BCL receiver now pours forth its stuff for the gang who set around and pour cigarette ashes on the deck, while at the same time I gather in the 600-meter weather reports for the old man on the ship's receiver. Everybody is happy but the Filipino mess boy who cleans up the shack. Might mention that I've got the .0001 Micadon fastened to a battery clip so that it can be quickly removed from the antenna when I am using the transmitter.

To avoid missing anything of importance that might be sent on 600 meters while I am copying press on the long waves, I set the BCL receiver for 600 meters and wear an extra pair of phones. This is a darned handy stunt, especially out here where typhoon reports are liable to come through at any time.

The Electrical Supply Company in Manila KZKZ is broadcasting every night from 8:30 to 9:30, using a 250-watt outfit on 400 meters. We ought to be able to pick them up about the time that daylight kills the Pacific Coast stations. Best 72½s,

MICKEY DORAN.

A duo-directional aerial will usually bring in stations from all directions better than the usual one-directional set-up. It is easily made by fastening the exact mid point of a 140 ft. length of No. 14 copper wire to the point from which the lead-in is taken and by fastening each end to supports 99 ft. from each other. This gives in effect two 70 ft. aerials at right angles to each other, the sides of the isoscles right triangle being respectively 70 ft., 70 ft. and 99 ft. A similar aerial of any other desired length can be obtained by multiplying the aerial length by 1.414 to get the distance between supports.

"The Jonah of Jasmine Bjones"

By George Sumner Albee

JASMINE BJONES was his name. It was a shame. Because he was free, white and twenty-one—quite a bit more than twenty-one—but for that matter it would have been a shame under any conditions.

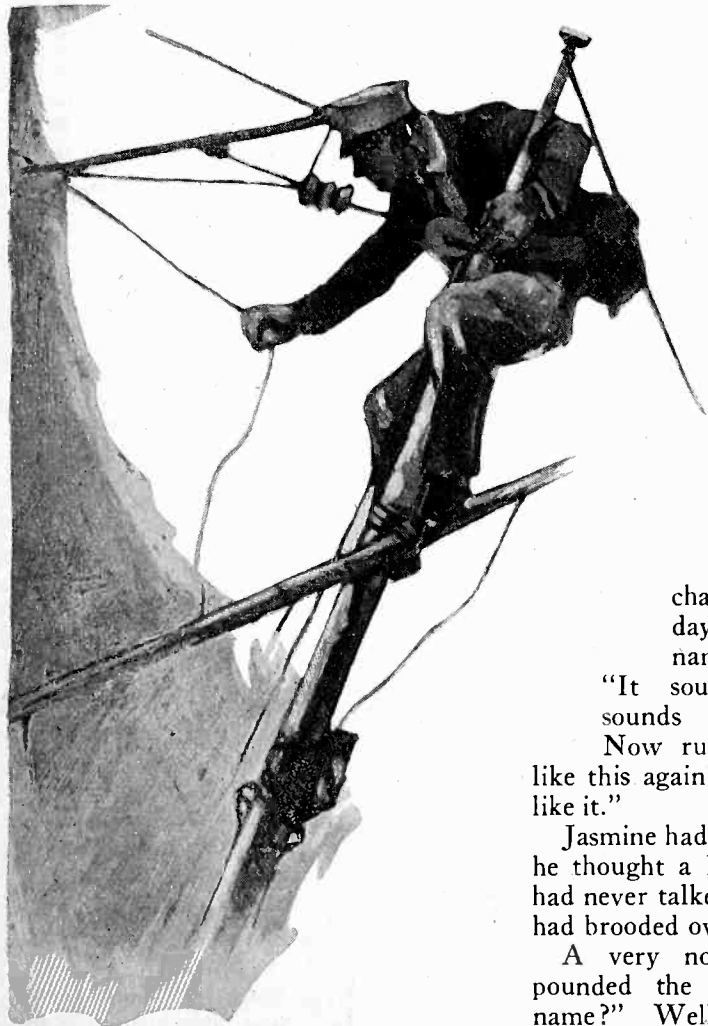

Jasmine himself had decided early in life, somewhere along about the eighth grade, that it was a shame; that his nom de plume was, so to speak, not so plume. His dissatisfaction had first arisen from

the fact that his classmates and teachers were addressing him as everything from Budgeons to Beejones, with sundry additional variations. He had gone immediately to his mother and asked her if she was positive that the preacher at the christening had not made an error, or something. Anything.

"Jasmine Onus Bjones!" she exclaimed. "The very idea! Wanting to change a name as beautiful as yours. Why, a jasmine is a gorgeous flower, son."

"But I am not a gorgeous flower, mother dear," he had protested. Which was true. At the time, his voice was changing and he was gawky, with myriad freckles and missing teeth.

"Society women down in the City are changing their names every day from plain Jones to our name," his mother continued.

"It sounds so arist-aristoc—it sounds *fine*, dear—so English.

Now run along, and never talk like this again. Your father might not like it."

Jasmine had run along, obediently, for he thought a lot of his mother, and he had never talked like that again. But he had brooded over it a lot.

A very noted personage has propounded the question, "What's in a name?" Well, there was this much in it for Jasmine. Naturally of a sensitive nature, his name daily seemed to become more terrible, more humorous. Because it seemed so funny, so heart-breakingly funny, to Jasmine, he reasoned that it must be funny to everybody else. He did not stop to think that though people might indeed be good-naturedly amused they would be far more interested in what he *was* and in what he could do than in what he was called. At sixteen he dreaded be-

ing introduced to people lest they laugh at him when his back was turned. If anyone did happen to smile at him he thought they were thinking of his name and quailed as if he had been dealt a blow. All this misery, for no reason. "What's in a name?" Ah,—

There is nothing more sensitive than a growing boy. By the time he had graduated from the small High School his hatred of having his cognomen hauled out in public brought him to the stage where he shrank from everyone. He lived alone with his mother, went nowhere, had no girl friends—never learned to dance. Thus the first jazz he heard came to him through what are sometimes called "cans." The full-fledged radio amateur calls them that; his father uses the term "head-set," while the poor worm next door, a mere B. C. L., a listener, says—"ear-tabs."

The gentle art of radiocasting was being born, and Jasmine alone, of all the town, knew it. He shared his knowledge with none of the people he hated and feared, would always hate and fear, though he might later learn to worry less about his name. Living practically in solitary confinement, the boy drifted naturally into radio. A spark and a two-step amplifier when only one other set existed in the small town up in the redwood country of California. And a receiver, with crystal—iron pyrites. When his mother followed his father Across, some months after his graduation, he decided to leave the place of his birth and all the unpleasant memories it held for him, and Ho! for the city and the newly acquired commercial license that was to open up the gates to the world and transport him joyfully to the far corners of the earth, even as the correspondence course advertisement in the radio magazine had promised.

But things did not all turn out as he had planned. So it is not until six or seven years have passed that we find Jasmine at last upon the decks of his first ship, after prolonged intervals of clerking, book-keeping, truck-driving through the streets of San Francisco, during which

Continued on Page 48

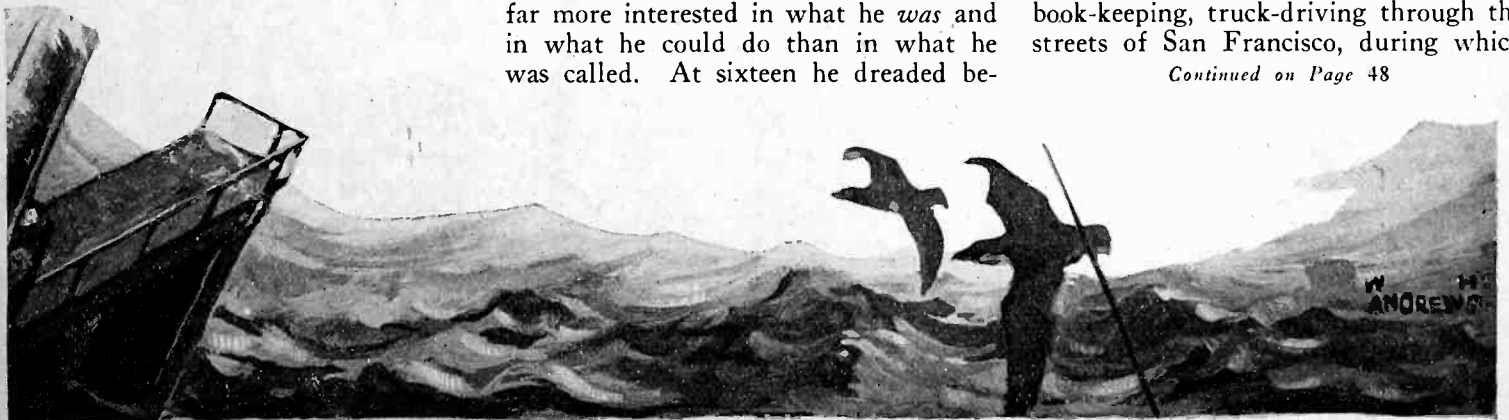

The Reactance Coupled Amplifier

An Explanation of Its Theory and Suggestions for Its Construction

By *L. R. Felder*

BUILDERS of receiving sets who have been confronted with the problem of securing as nearly perfect reproduction of speech and music as possible have recently been presented with details of the resistance coupled amplifier. Such an audio frequency amplifier, if properly built, will indeed give practically perfect reproduction.

However, the building of such an amplifier does involve certain disadvantages: First, the amplification obtained from a single resistance stage cannot be greater than the amplification constant of the tube, and is generally a little bit under it, whereas a single transformer stage gives from three to four times as much. As a result it is necessary to employ at least three stages of resistance amplification to give the same volume as two stages of transformer amplification. Second, to secure the maximum amplification from the resistance stage it is necessary to maintain the effective voltage on the plate of the tube at the same value as is employed in a transformer stage. This results in the necessity of employing practically twice the *B* battery required for the transformer stage. The reason for this is that a large part of the plate voltage drop is consumed in the external resistance of the resistance coupled amplifier, leaving only a part of the *B* battery voltage effective on the plate of the amplifying tube. In order to obtain the necessary plate voltage on the tube the *B* battery must be increased to compensate for the drop in the external plate resistance.

The constructor must make some sort of compromise here. If he does not care about the disadvantages and insists on perfect quality he will of course go in for a resistance coupled amplifier. If he is satisfied with the quality of a transformer amplifier it is best to stick to it.

There is, however, another choice in the matter, and this is really a compromise between the transformer coupled amplifier and the resistance coupled amplifier. This compromise lies in the reactance coupled amplifier. If properly built it will give slightly more amplification than the equivalent number of stages of resistance amplification, and it will not require any more plate battery than the conventional transformer coupled amplifier. At the same time the quality of reproduction will be as good as that of the resistance amplifier.

The circuit of the reactance coupled amplifier is essentially the same as that of the resistance coupled amplifier, except that in place of coupling resistances we employ coupling reactances. The circuit for a two-stage reactance coupled amplifier is shown in Fig. 1. In getting the proper results from such an amplifier the constants must be properly proportioned just as in the resistance coupled amplifier. The constants involved in such an amplifier are designated in Fig. 1, and are the plate inductances *L*, the coupling condensers *C* and the grid leaks *R*. The proper values of these units are determined by definite considerations which will now be taken up in order.

The value of the plate reactance *L* determines two things: First, the amount of amplification obtained; second, the amount of distortion. By properly choosing the value of this inductance, the distortion may be reduced to practically nothing, and at the same time the maximum amplification of the tube may be secured. The amplified voltage developed in the tube divides itself between the internal plate resistance of the tube and the external plate reactance. Now in an amplifier it is desired that most of the amplified voltage be available across the external plate coupling

unit, in this case the plate reactance, for it is this voltage which is passed on to the grid of the succeeding tube. It follows therefore that if the external reactance is small compared to the tube resistance most of the amplified voltage will be consumed inside the tube resistance and only a small part will be available across the plate reactor for use in the succeeding stage of the amplifier. On the other hand if the external plate reactance is very large compared to the tube resistance only a small part of the amplified voltage developed inside of the tube will be lost in the internal resistance of the tube, and the major portion will be available across the external reactance for use in the next stage. In other words the amplified voltage divides itself here between the tube resistance and external reactance, and it does so in proportion to their impedances. If we make the reactance extremely great compared to the tube resistance practically all of the amplified voltage will appear across the reactance and only a minute portion of it will be consumed inside the tube resistance.

The internal resistance of the average amplifier tube is about 20,000 ohms. To make an inductance whose reactance value is extremely great compared to 20,000 ohms will require a great many turns on an iron core. If we analyze the reactance circuit mathematically we find that when the reactance is two times as great as the tube resistance about 90 per cent of the amplified voltage is available across the external reactance. When the reactance is three times as great as the tube resistance about 93 per cent of the entire amplified voltage is available across the external reactance. When the reactance is four times the tube resistance about 97 per cent of the entire amplified voltage is available across the reactance. It is thus seen that the reactance should be at least three times the tube resistance, and that in this case almost all of the voltage is secured. Further increases in reactance values result in relatively small increases in amplification.

The reactance of an inductance or choke coil varies with the frequency. Thus it is possible for the inductance to have such value that its reactance at 2,000 cycles is three times the tube resistance, or 60,000 ohms, whereas its reactance at 100 cycles would only be 3,000 ohms. The effect is that frequencies under 2,000 cycles are not amplified as much as those above 2,000 cycles,

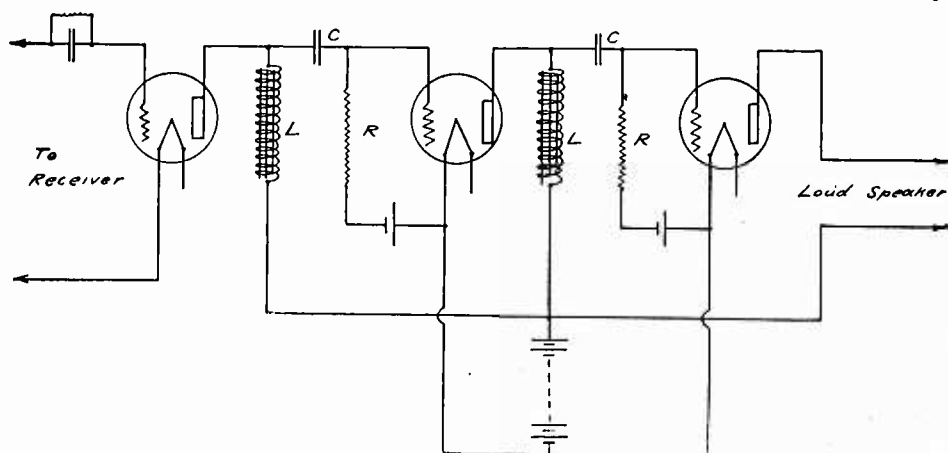

Fig. 1. Circuit Diagram of Two-Stage Reactance Coupled Amplifier.

and also that different frequencies below 2,000 cycles are amplified in different degrees. In other words distortions would result.

In order to prevent this it is necessary to make the inductance of such a value that its reactance at the lowest speech frequency, namely its lowest reactance, will be equal to at least three times the tube resistance. Then the reactance at any frequency above the lowest one will surely be at least three times the tube resistance. Actually the reactance will increase with the frequency, hence the higher frequencies will be amplified somewhat more than the lower ones. The actual amount they are amplified more than the lowest frequencies is, however, so small that the distortion produced is really negligible. Thus if the reactance at the lowest frequency is three times the tube resistance the voltage across the reactance is 93 per cent of the entire voltage. Above this frequency the increase in amplification cannot be more than 7 per cent at the maximum, and really is never more than about 4% or 5%, and this is hardly noticeable.

If, on the other hand, the inductance is made of such value that its reactance at the lowest speech frequency is 4 times the tube resistance then 97 per cent of the total voltage is secured across the reactance. In this case frequencies above the lowest could not be amplified more than 3 per cent more than the lowest, which is really distortionless amplification. Even if the very high frequencies above 3,000 or 4,000 cycles were amplified a little bit more than those below it no harm would be done. For it is a notorious fact that loud speakers cut off the higher frequencies. Hence a little more amplification at these frequencies would tend to balance to some extent the defects of the loud speaker.

We thus see that for distortionless amplification our first requirement for the reactance coupled amplifier is that the plate reactance must have an inductance such that its reactance at the lowest speech frequency is at least three or four times the tube resistance. Since the average tube has a plate resistance of 20,000 ohms the reactance at the lowest speech frequency must be between 60,000 and 80,000 ohms. The lowest speech frequency may be taken as 50 cycles. Hence the inductance of the plate reactor should be from 200 to 260 henrys in value. Using such a value of plate inductance will give maximum and distortionless amplification.

The problems of securing such a very high inductance in small space is quite a difficult one, especially if one desires to wind his own inductance. Winding a small coil means using very fine wire such as No. 40, and unless one has facilities for winding such fine wire it is best to buy a coil of the specified inductance. The writer does not know of

any company manufacturing reactors of such high values and compact enough for use in receiving sets. As a compromise he has successfully used the secondary of an audio-frequency transformer. The primary of a bell-ringing transformer may also be used. While the inductance in neither case is as great as is required theoretically, excellent results may be secured by this means.

Having secured maximum undistorted voltage across the plate reactor the next problem is to transfer this voltage undistorted and undiminished to the grid of the succeeding tube. The voltage from the reactor is coupled to the grid of the next tube through the coupling condenser *C*, Fig. 1. The condenser serves the purpose of transmitting the audio frequency voltages to the grid and also of preventing the high positive potential of the *B* battery from being applied to the grid. The value of the condenser *C* must be such that it does not cut down the voltage applied to the next grid, and also it must not transfer one frequency more efficiently than another and so produce distortion.

A condenser has reactance and so opposes the passage of current through it. Since the amplified voltage across the reactor must pass through the condenser *C* some of the voltage will be lost across the condenser reactance. To reduce this to a minimum the condenser *C* must have a very low reactance as compared to the reactance of the plate inductance. Not only that but to avoid the introduction of distortions the condenser reactance at its highest value must be very low compared to the plate reactance.

Thus suppose that the condenser value were such that its reactance at 10,000 cycles were 1% of the reactance of the plate inductance. This means that only 1% of the amplified voltage would be lost in the condenser reactance on its passage from one tube to the grid of the next tube. However, the reactance of this condenser at 100 cycles would then be 100 times as great as at 10,000 cycles, in other words would be equal to the plate reactance, hence half the voltage would be lost in the condenser. In this way distortions would arise, due to unequal transfer of the various frequencies. It therefore is necessary to make *C* of such value that its reactance at the lowest speech frequency is very small compared to the plate reactance.

A reasonable value for *C* is 1 mfd. This has a reactance of 3,000 ohms at 50 cycles, our lowest speech frequency. Since the plate reactance is about 60,000 to 80,000 ohms only about 3% to 5% of the voltage will be lost in the coupling condenser, at the lowest frequency. At 100 cycles only about 2% is lost in the condenser, and as the frequency increases the loss is less and less. If a 2 mfd. condenser is used, the loss in voltage in the condenser at the lowest

frequency is reduced to 2%, and above this frequency it decreases also. In either case the loss is so small that we may regard this as uniform amplification at all frequencies.

The coupling condenser should be one which is capable of withstanding the entire plate voltage and should have very high insulation resistance. If its leakage is appreciable, some positive potential from the plate battery may get to the grid of the succeeding tube. The best type of condenser to use is the Western Electric No. 21-AK, 1 mfd. If 2 mfd. are used two of these may be used in parallel, or better still, one Western Electric No. 21-D, 2 mfd. condenser will do. Both of these are capable of withstanding the voltage generally employed in audio frequency amplifiers. If these condensers are not available, a Kellogg No. 62 condenser (2 mfd.) may be used to advantage.

The function of the grid leak is, of course, to furnish a path for the discharge of any negative voltages which may be accumulated on the grid, for otherwise this negative charge, if it increases, may block the tube, prevent passage of plate circuit, and thus prevent the tube from functioning. Its value must likewise be carefully chosen in order to avoid reducing the amplification of the previous tube.

The grid leak may be regarded as being in parallel with the plate reactor for audio frequencies, for the coupling condenser has negligible reactance compared to the plate reactor. Thus, if *R* is made very small it is equivalent to shunting the plate reactance with a small resistance, which has the effect of reducing the effective impedance in the plate circuit of the tube and thus reducing the amplification. In other words, the grid leak must have a value such that if placed in parallel with the plate reactance it will not reduce the effective impedance in the plate circuit. In this case any value of grid leak above 500,000 ohms will be found to leave the effective impedance in the plate circuit unchanged.

On the other hand, the grid leak must not be made too great. Thus if a leak of 10 megohms is used, it may be found that the above mentioned blocking may occur, because the negative charge leaks off too slowly through a high leak. That is, the grid may be charging up negatively faster than it discharges through the high leak. In general, with the above mentioned constants for *L* and *C* almost any value between 500,000 ohms and 2 megohms will be found suitable for the grid leak. It will be observed that a *C* battery is used to apply a small negative potential to the grids of the amplifier tubes. This is to obtain an operating point for the amplifier which will enable distortionless amplification to be secured. Without this *C*

Continued on Page 80

An Improved Interference Eliminator

An Instrument of Universal Adaptability for Rejecting Undesired External Sounds From a Receiver

By F. L. Ulrich

SINCE my original article on an interference eliminator I have been flooded with mail wanting to know more about it, and stating the results obtained. For the benefit of those who did not see this article I will explain the principles, object and functions.

The main object is to decrease the interference (static, harmonics, interference from other nearby stations, etc.) It makes the receiver very selective and increases its receiving range, although this receiver is not recommended for volume but for distance. The desired volume may be reached by adding amplification. This interference eliminator may be used with almost any type of receiver and any design of antenna and ground system.

The tuner for this circuit as shown in Fig. 3 may be constructed as follows: Upon a bakelite tube $3\frac{1}{2}$ in. in diameter and 7 in. long, $\frac{1}{2}$ in. from the edge, wind 2 turns of No. 14 DCC copper wire this being the primary winding; $\frac{1}{2}$ in. from this winding wind 30 turns of No. 24 DCC copper wire, this being the tickler; 1 in. from this wind 30 turns of No. 22 DCC copper wire tapped every sixth turn, making five taps in all, this being the primary loading coil. Then obtain a wooden rotor to rotate snugly inside of this tube and wind it with 30 turns of No. 22 DCC copper wire tapping it in the center, so that when contact is made at the center tap stations may be tuned in that are transmitting in the vicinity 100 meters.

A hollow brass tube 6 in. long and $\frac{3}{16}$ in. in diameter may be used as a shaft for this rotor. The leads from the winding are brought out through the hollow shaft, preventing injury to the leads while the rotor is being rotated.

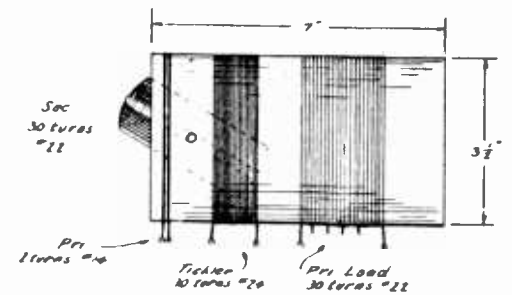

Fig. 3. Tuner for Interference Eliminator

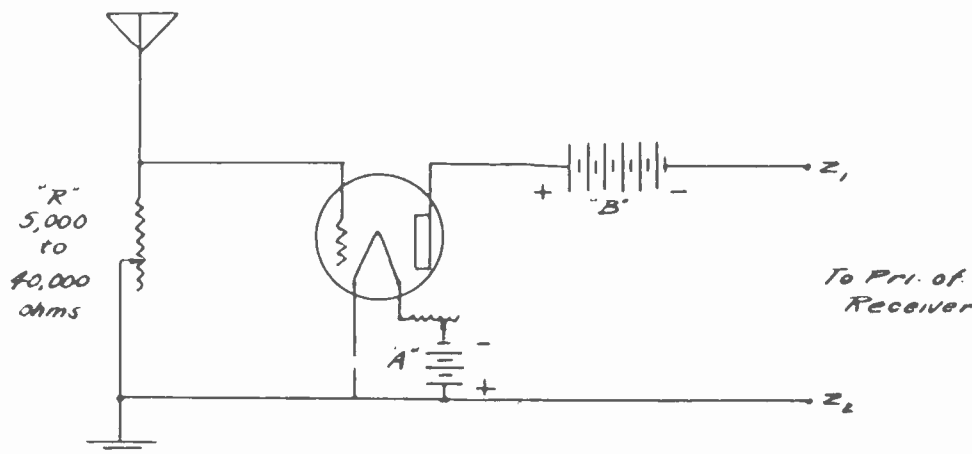

Fig. 1. Circuit of Interference Eliminator

Fig. 1 shows the circuit. The leads Z_1 and Z_2 may be connected to the primary circuit of any receiver. R is a non inductive variable resistance from 5,000 to 40,000 ohms. The adjustment of this resistance depends upon the type of tube used and controls oscillations of the coupling tube (this tube is called the coupling tube or radio frequency amplifying tube because it couples the antenna to the receiver and is used as a radio frequency amplifier). Any type of standard receiving tube should give fair results when used as the coupling tube, although Western Electric VT 1, known as the J tube was used in these experiments.

Fig. 2 shows the circuit as published in May RADIO. This circuit will tune from about 80 to 220 meters. Broadcasting and amateur stations transmitting on these low waves can be heard with ease. The wave length may be increased for higher wave lengths by increasing the capacity shunting the primary and secondary circuits.

The primary, secondary and tickler are shunted with a variable capacity of .0005 mfd.

Tune the receiver as usual. Then vary the resistance R until the oscillation of the coupling tube is heard. The primary loading coil should be cut out when listening on short waves (100 meters) and the secondary switch arm should be at the center tap. When tuning above these waves use full secondary and increase primary loading coil. Minimum coupling is established by using but two primary turns coupled to the secondary which will give sharp tuning.

Continued on Page 84

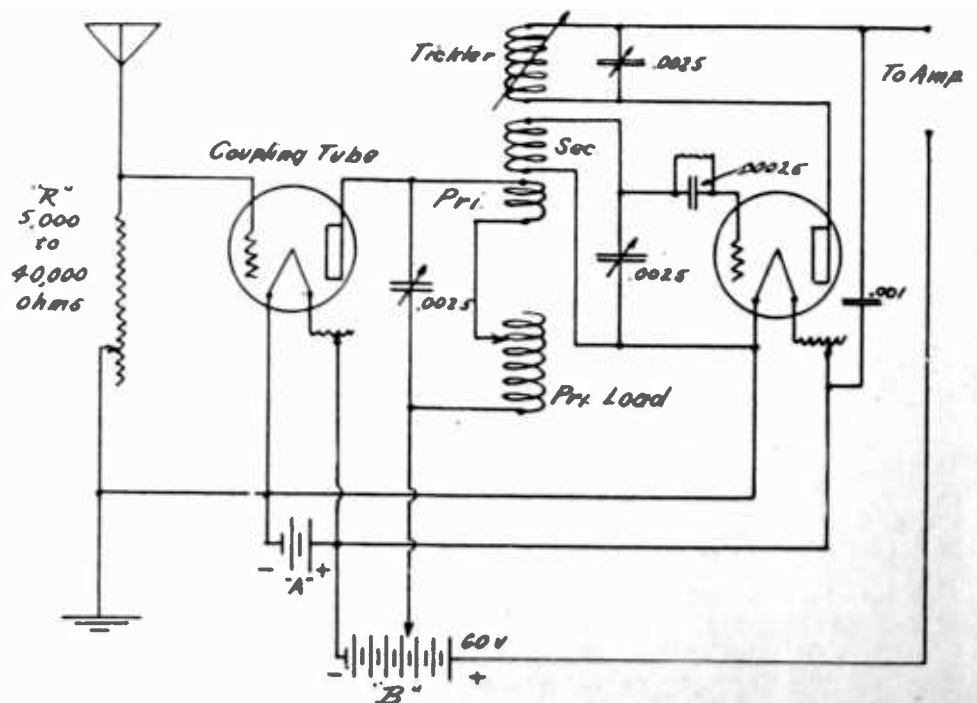

Fig. 2. Eliminator Circuit With Detector

Resistance Control of Regeneration in Tuned Circuit Radio Frequency Amplifiers

A Commonsense Discussion of R. F. Amplification and an Exposé of Several Fallacies Thereof

By C. M. Fansky, Jr.

BUT few individuals appear to really understand why better results can be obtained by the use of radio frequency amplification ahead of the detector circuit than by increasing the number of stages of audio frequency amplification beyond that in the average set. The usual reason advanced that a detector is a current square device and therefore operates best on strong signals, is not substantiated by mathematical analysis. It is often true that a detector will not operate satisfactorily on weak signals, but this is due either to incorrect adjustment of the grid bias or to the use of a tube which will not deliver sufficient grid current, and not to the fact that a tube detector gives a response in the plate circuit which is proportional to the square of the amplitude of the high frequency voltage impressed on the grid.

The fact that imperfect tubes and incorrect adjustment of circuits often prevent detection of weak signals is one reason for the use of radio frequency amplification in place of additional stages of audio frequency amplification. The fact that audio frequency noises originating in the tube circuits or elsewhere are in general not amplified by radio frequency amplifiers, whereas they may be amplified many times by audio frequency amplifiers, is a second reason for the use of radio frequency amplification.

Perhaps the most important reason, however, is the increase in selectivity which can be obtained with proper circuits. This selectivity is much more pronounced in the tuned circuit amplifier than in the radio frequency transformer coupled amplifier as it is primarily due to the use of a system of tuned circuits interconnected by tubes so that the reaction of one circuit on the preceding circuit is small although it is very troublesome, as we shall see. Even though a two or three-stage tuned circuit radio frequency amplifier might not deliver to the detector a stronger signal than could be obtained by connecting the detector circuit directly to the antenna, its use might be justified on the basis of the increased selectivity obtained.

Fig. 1 shows a theoretical diagram for a tuned circuit amplifier. This circuit is not recommended for actual use and will only be used to illustrate the principles involved. Selectivity is due

to the fact that three separate low resistance circuits must be tuned to the incoming signal before maximum signal strength can be obtained. The incoming signal produces an alternating current of like frequency in the plate circuit of the first tube. The condensers C are large so any voltage across the condenser C_1 and coil L_1 in the plate circuit of the first tube will be impressed between the grid and filament of the sec-

tion is due to the fact that the voltage induced on the grid by the alternating voltage across the plate circuit impedance is of such value as to accentuate the changes in the plate current. (See article by the writer in RADIO for October, 1924.) It is evident that if circuit B containing $L_1 C_1$ is tuned exactly to the frequency of the aerial circuit A we have a condition where oscillations will surely be produced provided the system is amplifying efficiently and

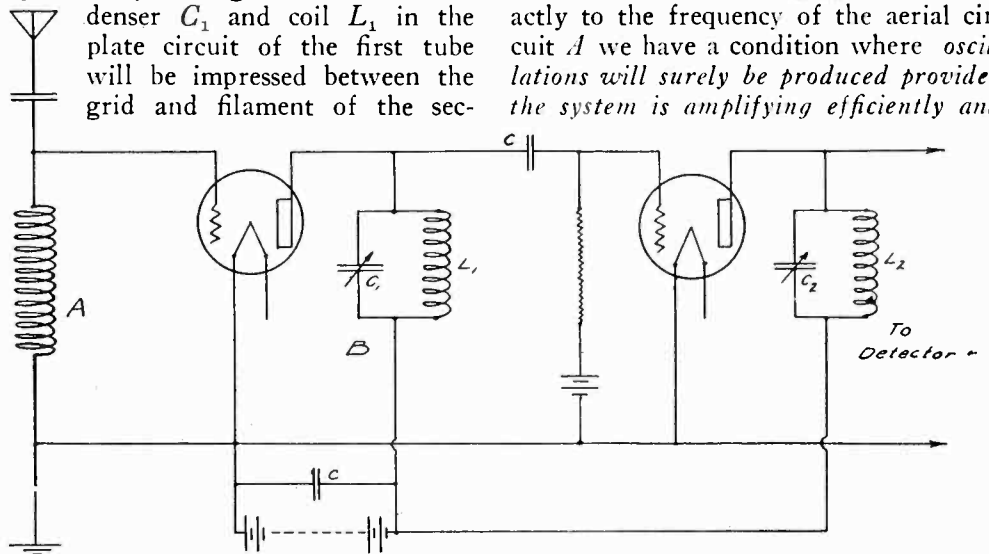

Fig. 1. Theoretical Tuned Circuit Radio Frequency Amplifier.

ond tube. This voltage will be a maximum when the circuit $L_1 C_1$ is tuned to the incoming frequency.

It now becomes necessary to discuss why this circuit is not useable in its present form. It will be remembered that one method of obtaining regeneration was to make use of the capacitance which exists between the plate and grid of the tube and adjacent wiring connections. With a variometer or a tuned circuit in the plate of the tube regeneration to the point of oscillation and beyond can be produced. This regenera-

tion is not dependent on any coupling between circuits A and B other than the capacitance between the elements of the tube and it cannot be prevented by placing the coils and condensers in any particular position or by winding the coils in any particular direction. These statements are made to emphasize the fact that the production of oscillations in a circuit of this type, is inherent if the system is worthy of being called an amplifier at all.

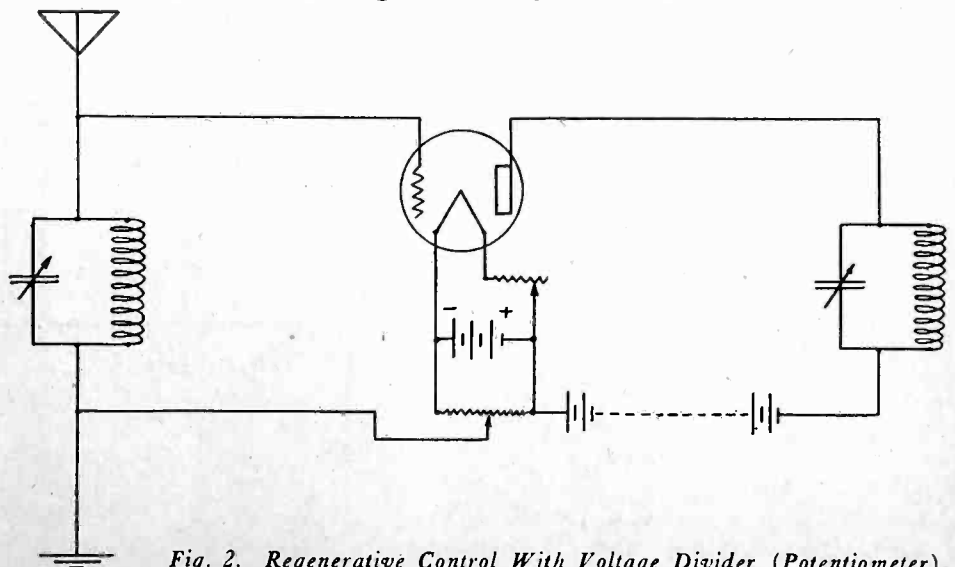

Fig. 2. Regenerative Control With Voltage Divider (Potentiometer).

The prevention of oscillations in a tuned circuit radio frequency amplifier may be characterized as "regeneration limitation." Regeneration may be limited in one of two ways. The first method consists in the deliberate or unconscious introduction of loss into one or both of the radio frequency circuits. This method of regeneration limitation has been ably characterized by one writer as dignified not by its merit so much as by its extensive practice. (See article on "Anti-Regenerative Amplification" by Louis M. Hull in Q. S. T. for January, 1924.)

A very common method of limiting regeneration is by the use of a voltage divider (potentiometer) as shown in Fig. 2. The sliding contact is used to place a positive potential on the grid. The grid current which results may be made sufficiently great to limit the amplification to a point where oscillations will not be produced. A very serious objection to this method of regeneration limitation is the fact that a tube

will be to neutralize the effect of this resistance it is equally true that from a practical standpoint the system will not be as selective as it would be if the resistance had been left out and some other method of regeneration control had been used. The advantage of the resistance or loss method of regeneration control is that it is extremely simple and can easily be introduced and used with any tuned circuit radio frequency amplifier.

Because of this simplicity it is suggested that those desirous of experimenting with tuned radio frequency amplifier circuits begin their studies by using some circuit like those shown in Figs. 3 and 4 which will give surprising results. A number of manufacturers now have on the market variable resistances of the non-inductive type which can be inserted into radio frequency circuits to provide the loss necessary to limit regeneration.

The potentiometer system of control as shown in Fig. 2 is not recommended

the loss method of control is used the resistance be introduced directly into the radio frequency circuit rather than to rely upon indefinite resistances and losses due to imperfect apparatus and high resistance coils and condensers. After the experimenter has realized the full possibilities and understands the limitations of the loss methods of regeneration control he will be in a better position to understand and use those methods of control which strike directly at the real reason for the production of oscillation in tuned circuit radio frequency amplifiers. These methods of control will be discussed next month in RADIO.

There is another kind of regeneration limitation by the loss method which for want of a better name I will call "Unconscious limitation of regeneration by the introduction of unknown or undefined losses and resistances." This method is in use by those who state that their circuits do not need to provide for a neutralization of the feed-back effect between plate and grid or for resistance loss which will prevent the production of oscillations.

In such circuits *regeneration limitation does exist regardless of statements to the contrary and it is invariably of the loss type.* The losses are introduced either consciously or unconsciously by the use of high resistance windings, high resistance condensers, improper adjustments, and even by such simple methods as reducing the filament current of the tube to such a point that amplification is partly or completely destroyed. The objection to such circuits is of course obvious. If the location of the limiting resistance is unknown or undefined, they cannot be properly varied and regeneration cannot be satisfactorily controlled. The operator does not understand the principles involved because they have not been pointed out and he has no means of knowing whether or not his adjustments are correct. The designers of such circuits either do not know or refuse to recognize the fundamental principles involved.

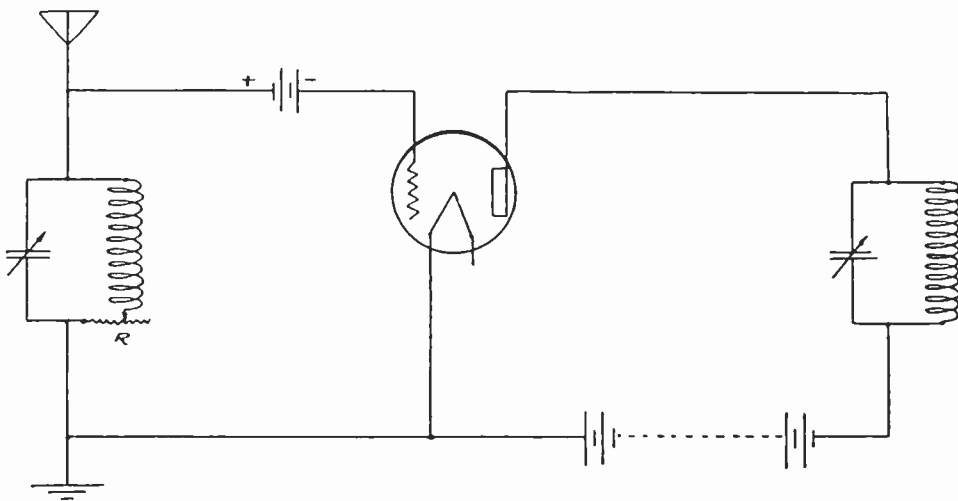

Fig. 3. Limitation of Regeneration With Series Resistance.

operating with a positive grid bias acts as a very good rectifier or detector and therefore considerable distortion is produced.

A better way to introduce losses into the circuit is to introduce resistance either in series or parallel with one of the radio frequency circuits as shown in Figs. 3 and 4. The maximum value of R as shown in Fig. 3 should be about 50 ohms. Adjustment of the amount of loss in Fig. 4 is obtained by adjusting the condenser C which should be of a very small capacitance. In Fig. 4 R should have a value of about 50,000 ohms.

Control of regeneration by the three methods outlined above is open to the objection that it is based on the introduction of resistance into one of the high frequency circuits which tends to decrease the selectivity of the entire system. While it is true that the effect of any regeneration left in the system

because, as has been stated, it produces distortion. In addition, the use of the positive grid potential necessary for regeneration control produces an excessive plate current which will cause the rapid deterioration of the average B battery.

It is particularly important that if

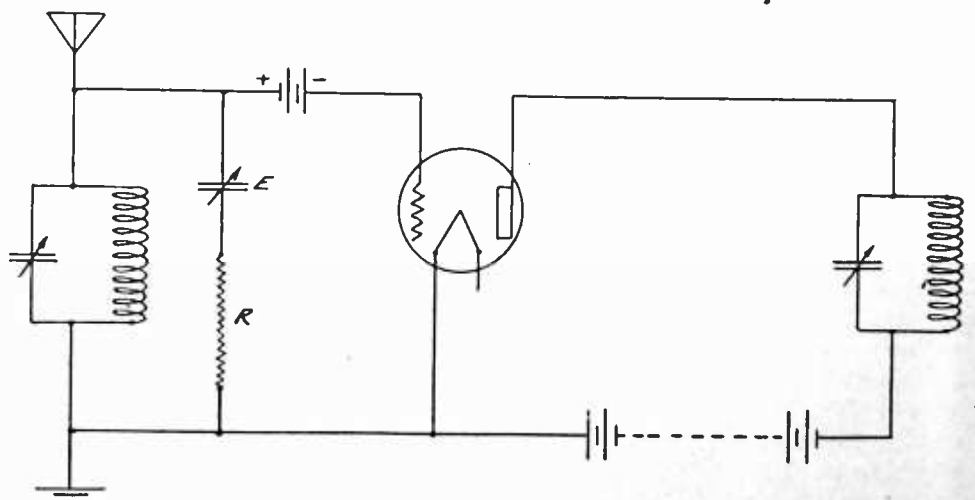

Fig. 4. Limitation of Regeneration With Shunt Resistance.

More About the Harmonic Transmitter

Further Details Concerning a Practical Method for Getting Down to The Shorter Wavelengths

By F. Dawson Bliley, 8XC

THERE is nothing new about working antennas on their harmonics. This useful method has been "discovered" many times through the oscillating of an apparently unresonant circuit. But it has not become generally known since there has been no demand for working an antenna below its fundamental.

Ballentine says that the fundamental of the antenna is the best wave at which to work our transmitters and as each harmonic is really a fundamental wave whose frequency depends only on the original fundamental frequency, then each harmonic is the best place at which to operate. However, I wouldn't carry this any farther than about the twentieth harmonic since they tend to get weak. The harmonics do not get stronger as they approach the fundamental wave; on the contrary they often get stronger as they are farther away. Regardless of wave the following harmonics are given as found at 8XC varying from greatest intensity to least: 3, 5, 4, 2, 9, 12, while 6, 7, 8, 10, etc. were good. (This may be decidedly different at your station).

The transmitter in Fig. 1 if properly

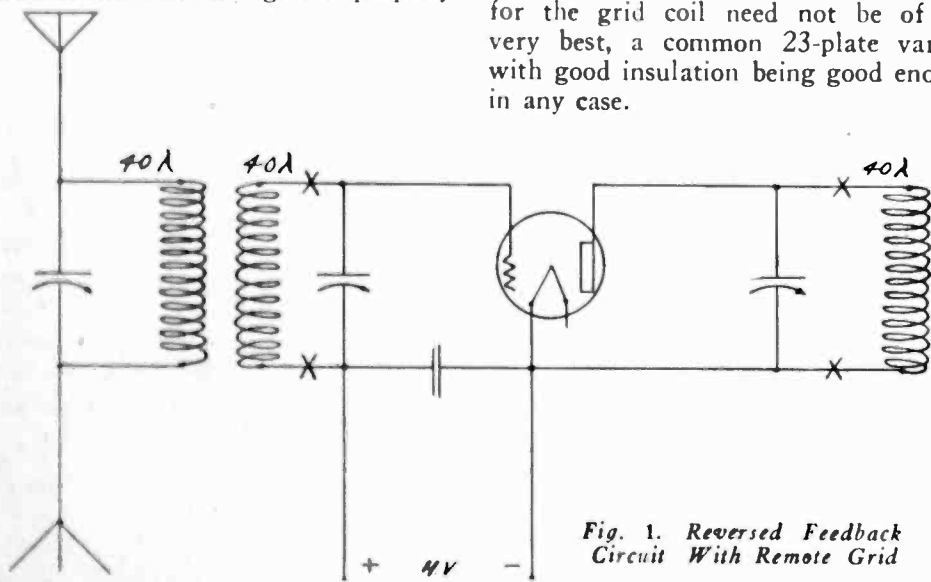

Fig. 1. Reversed Feedback Circuit With Remote Grid

built, will have as great a range as any "wave hound" would wish. This transmitting circuit will oscillate freely over the whole range from 10 to 90 (or more) meters. The tube should get no redder at 10 than at 90 meters if the circuit is in proper resonance and the losses from coils and condensers are kept as low as is possible.

There are three coils in the hookup; the antenna, plate, and remote grid coil. The antenna coil, as well as the plate coil, is Lorentz style (low loss). This

type is easily made by winding No. 12 DCC (or cotton-enamel) copper wire on a form with five pegs 5 in. in diameter. Five pegs will be sufficient since a greater number would only add to the capacity of the coils. Coils wound in such a manner, when hooked up, will change the wave about four meters per turn. (This is general—yours may be different).

Before removing the coil from the form be sure that a waxed thread has been inter-woven between the spaces to be left by the pegs; you can't expect these coils to hold their form. Having tied up the coil with the waxed thread and having removed it from the form, take the two free ends and wind empire cloth about them leaving about 2 in. of each wire loose. About $\frac{1}{2}$ in. up each end bend each wire to right angles so that they may easily be mounted and supported by two binding posts. It is best that the binding posts be mounted on pyrex glass for lowest losses.

Both the antenna and plate coils are mounted in this way but the grid coil, being remote, can be made in any manner, the radiation being the same at any time it is in resonance. The condenser for the grid coil need not be of the very best, a common 23-plate variety with good insulation being good enough in any case.

The antenna and plate coils do need good condensers since these two coils are the link between "getting out and not getting out." A poor condenser across the plate coil will burn out eventually so that it pays to get a good low-loss condenser in the first place. Many of us have heard stations whose wave jumps so much that it is impossible to copy. Such is probably the result of a poor condenser.

A good transmitting condenser can easily be made. Purchase a condenser

that is not of the "moulded mud" type and has good bakelite ends with the metallic connections to the two halves far apart in the insulation. Next take out half of the stationary plates and half of the rotary plates. This will double space all the plates and make it doubly hard for the radio frequency to jump between them. Such a condenser has a good range of wavelengths when placed across a coil.

The antenna coil does not have to be changed at any time in the tuning as the condenser across it will handle this nicely.

The plate coil will probably have to be changed three times in the range from 10 to 80 meters. For the ranges of 10-20, 20-40, and 40-80 meters the first coils should have about 3 turns, 6 turns, and 9 turns respectively (this is quite general).

The size of the grid coil can be found out by experiment, however the ranges of 10-30 and 30-80 meters can be made with little trouble.

The fundamental of the antenna should be at least 130 per cent of the highest wave to be used. A larger fundamental can be used with great advantage since the greater the fundamental wave the nearer the harmonics are together; which would not necessitate tuning the fundamental so much. In other words build as large an antenna as possible. A large antenna would mean a larger radiator and therefore a better chance of radiating more energy into the antenna and atmosphere.

The tuning is quite simple. It might be best to first place a double-pole, single-throw switch to disconnect the antenna coil from the condenser and antenna. Next tune the plate circuit to about the wave you would like to use (this will be guess work at first) and then tune the grid circuit to resonance. Be sure that you have a good wavemeter before tuning as the legal bands are quite narrow.

The "oscillator" (grid and plate circuit) having been tuned to a desirable wave, connect the antenna and vary the condenser until maximum radiation is found. This is simply tuning the fundamental around until one of its harmonics can be found that will fall on the wave that the set is tuned to.

The oscillator can be tuned to resonance by two methods. An ammeter is inserted in the plate lead and then the set is tuned for resonance. When the meter shows least drawing, the circuit is in resonance. If your tubes are red

enough to see they can be watched for sudden cooling when the circuit is in resonance.

If trouble is experienced with the reversed feedback with remote grid (Fig. 1) the circuit shown in Fig. 2 can be tried. This differs little from Fig. 1 except that it is somewhat more fussy due to the grid coil being so near to

The transmitting condenser across the coil need not have double spacing since it is not subject to such high frequencies. The two parts of the condenser should each be located midway between the extremities of the Hartley coil and the filament—which should be at the nodal point. This coil, if low-loss, should be composed of about 10 turns. It is better

A USEFUL MOLDABLE INSULATING MATERIAL

By SAMUEL G. McMEEN

What is one to do when he feels that he must make several insulating parts alike, in a form that will not permit the use of rods or sheets or tubes of bakelite, and has no equipment for the molding of bakelite or electrose?

What usually happens is that one does without, changing the plan of the work or dropping the endeavor entirely. Either course is to sidestep the problem, and that is bad for the moral fibre of the experimentalist and should be avoided wherever possible.

What is needed is a moldable substance of reasonable insulating qualities, workable without costly or elaborate equipment. It is to be had in a very gratifying degree in the following technique.

The plan embraces the making of plaster of paris casts of the object to be made, then saturating these with hot Brazilian wax. This wax is also known as Carnuba wax, and is of firm consistency and of considerable strength, as waxes go. It has the power of making the plaster cast harder than it would be without the wax treatment, and at the same time of increasing and preserving the insulating qualities.

To make the cast, first prepare the mold. This can be done in a variety of ways, each fitting the special circumstances of the situation. For simple parts, molds often can be turned from metal or wood. If the latter is used, saturate them with something that will resist the water used with the plaster. Paraffine serves the purpose. Beeswax is better. Have these waxes hot and immerse the mold till no more bubbles appear. Among the metals, one may suggest Babbitt metal, type metal, foundrymen's white metal and plain lead. As the plaster is not hot as used, any alloy of low melting point can be used for making the mold.

For molds for parts that are irregular, even those having heavy undercuts that would preclude the use of metal molds, one may well turn to the artists and copy their practice of making glue molds. These will enable us to copy irregular articles. To make them, soak good glue in cold water till soft; pour off the excess of water; heat till melted and add one ounce of glycerine to each ounce of the dry glue. Grease the object to be copied and immerse it in the glue mixture in a suitable vessel. When the glue composition has cooled, it will be of about the consistency of rather soft rubber, and about as flexible. Remove the whole lump from the containing vessel by warming the latter till the outside of the lump is melted a trifle, then cut down one side clear in to the object within, and pull the composition off of the object. It will come away from all the

Continued on Page 85

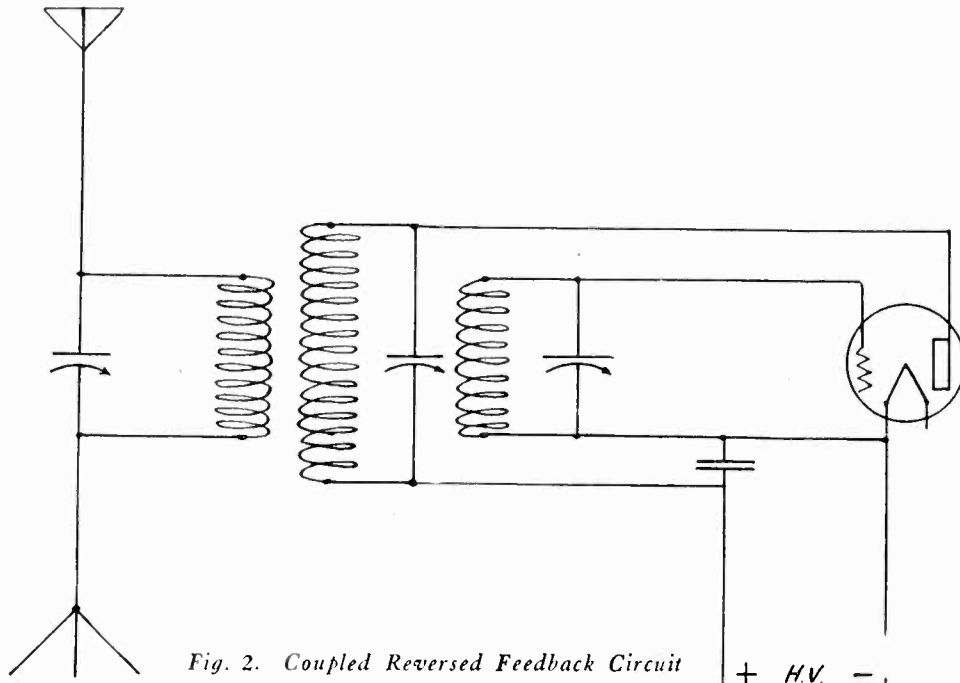

Fig. 2. Coupled Reversed Feedback Circuit

the plate and antenna coils. Trouble will probably be found in getting over all of the band of waves from 10-80 meters. The grid coil will have to be changed oftener and should be of the low-loss type not unlike that of the plate and antenna coils.

There is no coupled transmitting circuit which cannot be used for harmonic transmission. The coupled Hartley is probably the simplest. This is shown in Fig. 3. The only difficulty is that the range is not wider than that of the greatest condenser setting, since the coil could not be quickly changed, an extra on the coil having been used.

that too much wire is used rather than not enough as it is simpler to cut wire off than solder it on.

All of these circuits can be used with the same antenna, coil and condenser. 40 meters isn't such a dark mystery as some of the amateurs make it out to be. 40 meters is excellent, up to about midnight, for long distance work. It is very similar to the 80 meter band with which most of us are now familiar. 10 and 20 meters may be a different problem yet there is no reason why it should be. So get that set hooked up and QSY down to 40 and 20 meters away from that terrible interference on 80 meters.

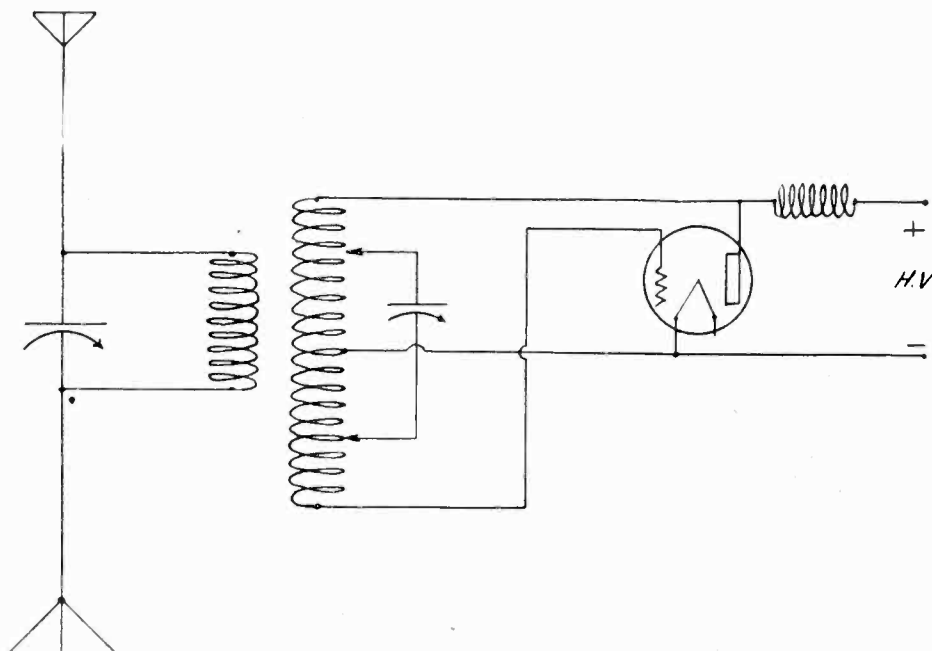

Fig. 3. Coupled Hartley Circuit

A New Coupling System for Transmitting Stations

Constructional and Operating Details of Energy Coupling for Hartley
Meissner and Reversed Feedback Circuits

By D. B. McGowan

THE coupling between the antenna radiating system and the local oscillator did not receive much attention until interference with nearby stations, particularly those listening on broadcast wavelengths, had to be eliminated. The primary purpose of a coupling system is to connect the antenna to the source of radio frequency energy so that the antenna will radiate electric waves of the frequency desired. Various means have been used, ranging from the obsolete systems of using the antenna itself as the source of oscillations, and inserting a spark gap in the circuit (the old Marconi "plain aerial connection"), to the newest system of inductive coupling, which recently appeared in the guise of the "tank circuit."

The direct coupling system, where one inductor was used for the closed and open circuit, followed the plain aerial system. It was more efficient because it removed the high potential low frequency supply and the energy-absorbing spark-gap from the antenna circuit. But its "coupling effects," whereby the radiating antenna system reacted upon the closed circuit, caused an undesired spark-gap action and resultant emission of two waves. With a properly designed quenched spark-gap this effect could be reduced to a minimum, so the spark-gap circuit did not affect the frequency of the antenna circuit, after the initial oscillation had taken place. The difficulties of getting and adjusting a satisfactory system whereby this effect could be eliminated on various wavelengths led to the adoption of "inductive coupling," whereby the antenna and local or "closed" circuits are tuned so that the antenna, with proper coupling, can radiate a single frequency at its own period. Its great advantage is that it minimizes the radiation of undesirable harmonics.

The "tank circuit," as developed by the General Electric Company, is a special form of inductive coupling, whereby the oscillator radiates into a dummy, or "tank" circuit, tuned to the emitted wave, which circuit is coupled electro-magnetically to the antenna or radiating circuit. This system greatly decreases interference from harmonics.

In amateur transmission the usual circuits are the Hartley, Meissner and reversed feedback. As originally designed, the Hartley and reversed feedback are direct coupled, while the Meissner is semi-direct coupled, the wave-

length being determined by the constants of the antenna circuit, and the grid and plate coils being coupled electro-magnetically to the antenna. These circuits can be designed to couple electro-magnetically to the antenna circuit by arranging them to oscillate into a dummy antenna, or condenser, and then coupling the antenna electro-magnetically to the closed circuit.

In practice the system must be care-

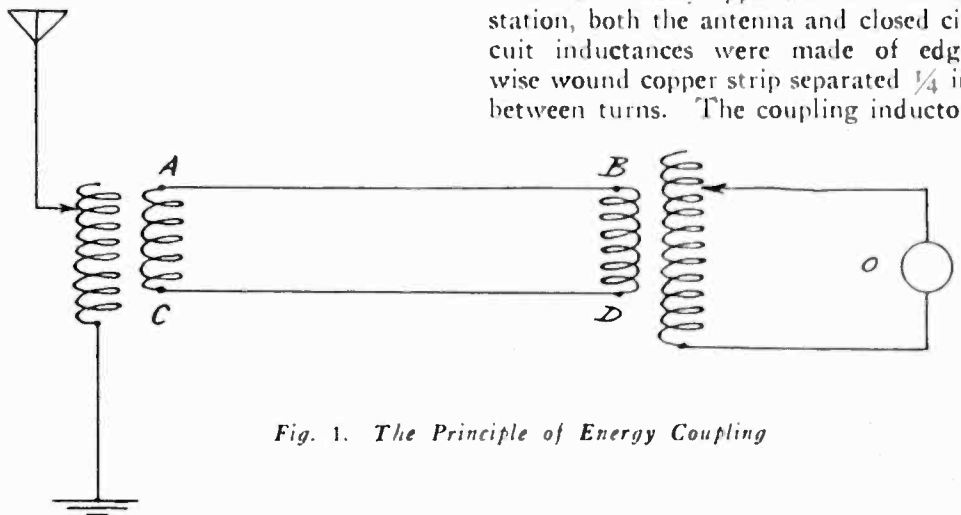

Fig. 1. The Principle of Energy Coupling

fully designed and the mutual coupling between circuits must be adjusted to a critical point. If the coupling between the closed and open circuits is too close the wavelength will "flop" in a most uncanny manner due to the change in wavelength caused by the interaction of the circuits. If too loose the energy output is low.

A system of energy coupling employed by several arc stations is shown in Fig. 1.

It employs two oscillatory circuits, each tuned to the same frequency. The energy from a local oscillator *O* is supplied to the antenna circuit through coupling inductances *AC* and *BD*. These are very closely coupled to their respective circuits, are absolutely untuned and are connected by the leads *AB* and *CD*, which may be of any length within reason.

As successfully applied at the writer's station, both the antenna and closed circuit inductances were made of edgewise wound copper strip separated $\frac{1}{4}$ in. between turns. The coupling inductors

were made by winding 2 turns of No. 10 rubber-covered stranded battery wire between the turns of the edgewise wound strips. Their ends were connected with No. 10 wire, distances up to 40 ft. separation between circuits causing no appreciable change in efficiency. The leads were run on wooden insulators and separated by 6-in. spacing.

Fig. 2 shows how the scheme was applied to a Hartley circuit with a variable

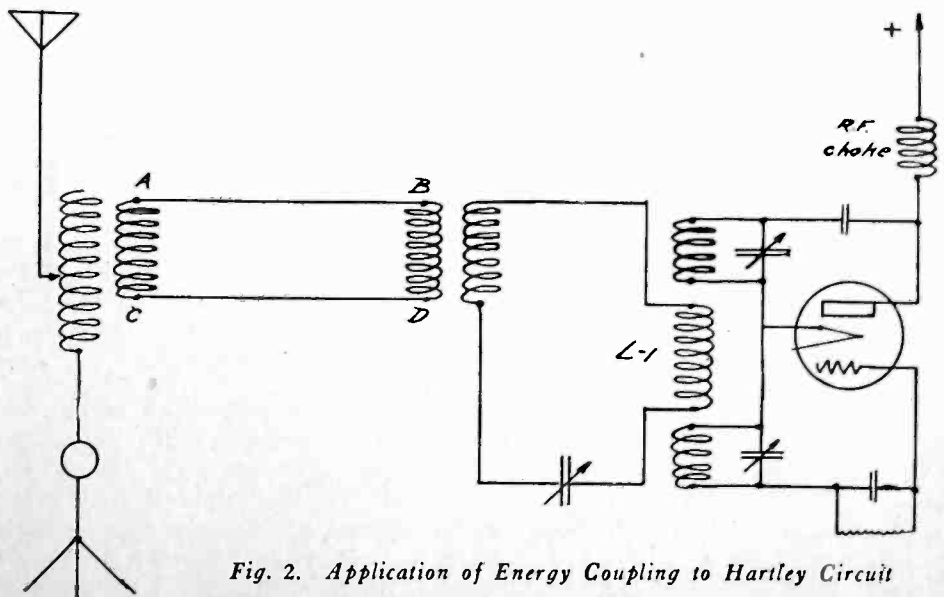

Fig. 2. Application of Energy Coupling to Hartley Circuit

condenser shunted across a part of the closed circuit inductance. Fig. 3 shows its adaptation to the Meissner circuit with a variable condenser as the dummy and a coupling inductance in series which also seems to bring the wavelength to the point desired. The adaptation to the reversed feed back is shown in Fig. 4 the circuit actually resolving itself into a Hartley with a separate tuned grid coil.

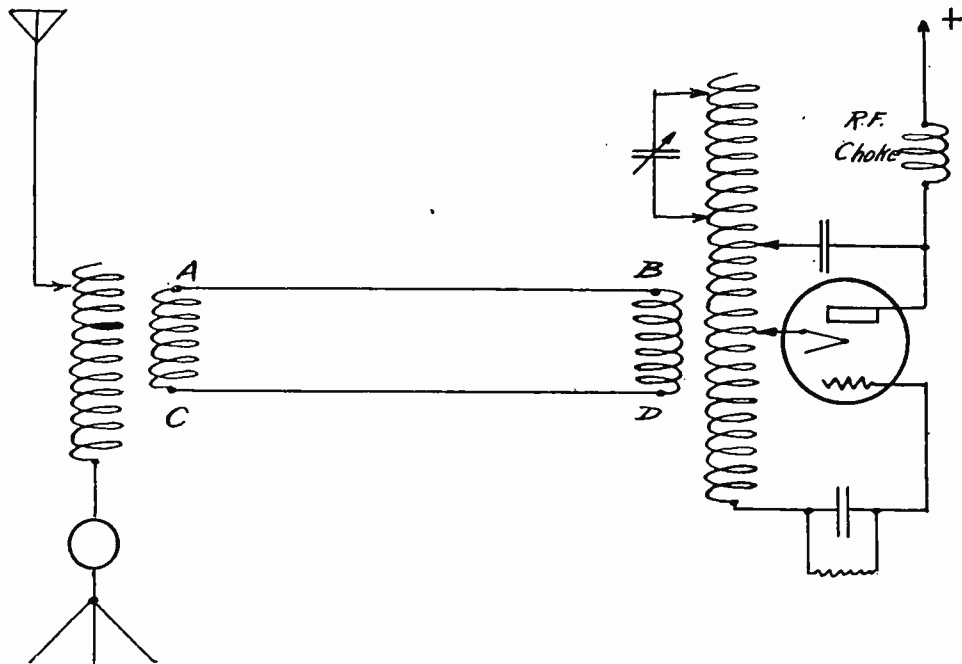

Fig. 3. Adaptation of Energy Coupling to Meissner Circuit

For simplicity and ease of tuning the energy coupled Hartley is hard to beat. For ordinary operation from 75 to 160 meters no change is necessary in the settings of the grid and plate taps in the closed circuit, once they are adjusted to approximately optimum positions. Then with a large variable condenser the whole wavelength range from about 50 to 150 meters can be covered, without re-adjustment. Using energy coupling,

trifle, but this may not be necessary, and usually cannot be found unless a grid milliammeter is used as well as the usual one in the plate circuit.

To reduce the wavelength below the fundamental wavelength of the antenna, the usual series condenser can be used. A small series condenser, of the so-called "lowloss" type, is usually recommended, assuming that it is actually constructed so that the losses will be at a minimum.

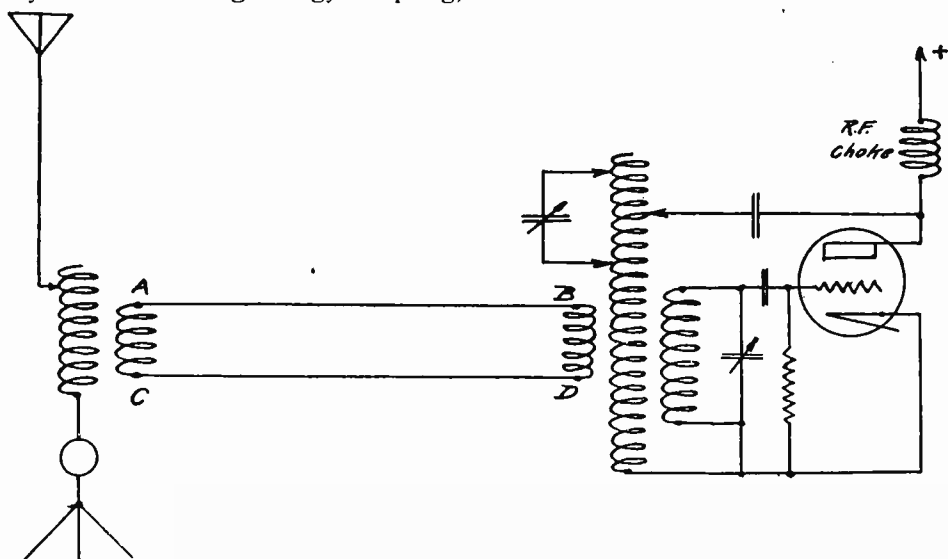

Fig. 4. Application to Reversed Feedback Circuit

therefore, all that remains to adjust is the antenna for the wavelength desired, and the set is tuned.

In practice, set the clip (note, there is only one) on the antenna inductance to some convenient point, and rotate the condenser until the highest reading is

Two series condensers are not necessary, usually, as the position of the nodal point seems to make but little difference. It may be found, however, that in some circumstances the use of two condensers is an advantage, as described in *QST* some months ago. When a series con-

denser is used, it should be remembered that a minimum of capacity and a maximum of inductance should be used at all times for best results, owing to the increased potential thus impressed upon the antenna circuit.

The chief advantages of this system are that it gives a wave free from harmonics and the emission of a maximum of energy for a given input. Furthermore it gives the ability to set up the oscillator inside of a station quite remote from the antenna. It is thus possible to put an antenna and counterpoise on the roof using a water-tight box to house the tuning inductors, and then run the leads down several stories, through the radio frequency power line, to the set. The difficulty in accurately tuning the closed circuit to resonance with the antenna was met by mounting the ammeter in the open circuit so that it could be seen from the operating table through a telescope. The closed circuit was then adjusted, and the ammeter reading noted through the telescope.

A FEATHERWEIGHT MAST

By F. K. LESLIE

In May, 1924 *QST*, 8KS told us he had a 65-ft. tin mast. However, that is about all he told us. If he had only mentioned how he raised it, what a lot of grief he would have saved me, and perhaps others. After several attempts at raising seven assembled 10-ft. sections of gutter spout skyward with a gin pole, I gave it up, also the pipe. However, I now can point with a bit of pride to 70 ft. of tin standing rigid and vertical, supporting a 40-lb. antenna 60 ft. long.

The mast is 3 in. D-No. 26 gauge corrugated galvanized conductor pipe, consisting of seven 10-ft. sections. The sections are joined by telescoping one within the other. I assembled three sections on the ground in this manner. Placing an end of one section against a solid support (I used the house foundation), I rammed, with a block of hard wood and a mallet, another section into it a distance of a foot. (The block of wood is used against the end of the pipe to prevent it from upsetting). Section No. 3 was likewise telescoped into No. 2. I found I could handle the assembled 30 ft. very nicely alone. On the end of Section No. 1 I fitted a tin can for a cap, soldering with a healthy blowtorch. Just below the can I wrapped two turns of flexible galvanized clothesline through the pulley eye, soldering the wire at all the high spots to the pipe. The top set of three guy wires were also wrapped and soldered to this loop. (Here I might add that raw muriatic acid is the best flux).

The same was done at the joint of section 2 and section 3, this being the middle set of guys. The assembled 30

Continued on Page 84

The "C" Battery Produces A Surprise

A Graphic Account of how the Input From a Hartley Circuit was Increased 50 Per Cent

By L. W. Hatry

THE phenomenon which I am about to relate, may be one of those oddities that individual sets are prone to have. Therefore, I won't be careless enough to claim that it should work for everyone, but only that there might be some others who can benefit by the knowledge.

It happened when I discovered the surprise that I was using the Hartley circuit with the shunt feed as shown in Fig. 1. The grid condenser was the

2.1 down to 2, and my new antenna current 2.4 to 2.5. Multiplying the old antenna current by the square root of the new power of 1.5, is expressed 2×1.2 and the product is 2.4, the theoretical antenna current to be obtained by a 50 per cent increase in power. Thus the theory and practice checked for once.

Presuming from the result with the C battery that my grid condenser and leak might be wrong, I repeated all my tests for best values of those two con-

had been trying to accomplish with exciting plate voltages and other expedients, and was therefore the more useful, being convenient and easy.

Similar experiments with the reversed feedback circuit were unsuccessful. I am at loss to account for the action of the C battery in the Hartley circuit and its impotency in the Rev. Fbk.

Now, if you wish to try this C battery stunt, its arrangement is shown in Fig. 1. In my case the correct value of C battery was 67.5 volts, and it is advisable to have at least 90 volts on tap, variable in 1.5 volt steps from the first 45. But don't allow the lack of such a variable battery keep you from trying the C battery, if you have a fixed one. You will need greater or less value of C battery as your plate voltage is greater or less than 500. The C battery should be shunted by a condenser of at least .005 capacity or greater, it doesn't matter how much greater. Two rf chokes will be required in the leads to the C battery, as shown, unless you mount it so that it provides minimum length grid leads, and insulate it from leakage. Where you mount the C battery under the table or some way that requires very long leads, the two rf chokes are neces-

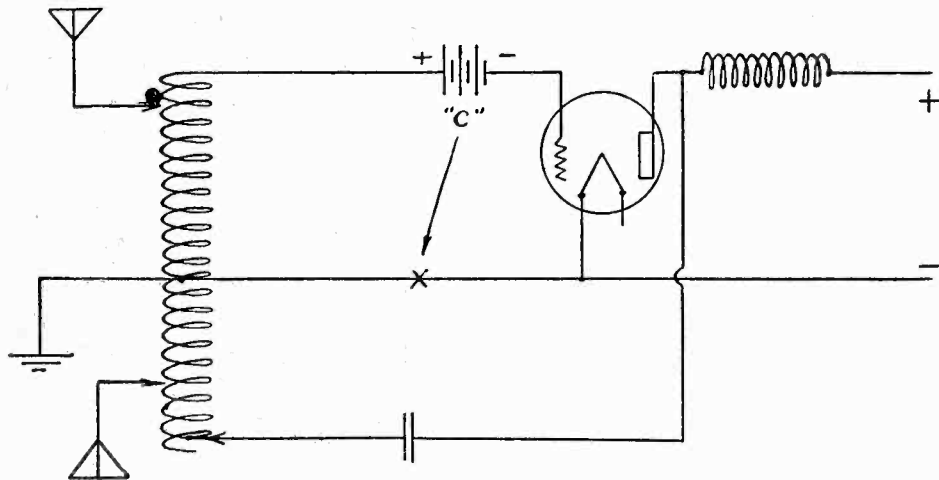

Fig. 1. Hartley Circuit With Shunt Feed, With "C" Battery in Grid Lead; "X" Shows Where Also Tried.

usual .002 and the grid-leak, 12,500 ohms, these having been found the best values for my set. A tuned choke in series with the grid-leak eliminated the small loss inevitable with one not protected in that manner. Two 5-watt tubes were used and the input was 100 milamps at 550 volts dc, 55 watts. With commendable curiosity I wondered if a C battery was of any account, and if it would produce identical results with the grid condenser and leak, which, to my mind, it should. It didn't! I replaced the condenser and leak with the C battery, adjusted it and the set carefully, and found myself with a 50 per cent increase in input, 150 mils now, and a .4 higher antenna current.

Figures immediately revealed to me that the set was functioning as efficiently as before but at greater power. The antenna current, as I suppose most of you know, varies as the square root of the power supplied to the antenna. The power supplied the antenna varies directly with the input, so we are allowed the obvious inference that the antenna current varies with the square root of the input power to the set. Thus, considering my original power input as 1, my new power input became 1.5; my original antenna current was

starts, thereby causing myself about three hours' work. (It might be mentioned here that most of the two-tube sets for which I have obtained figures, had a plate input of 60 to 90 mils at 500 volts mgdc. Some 4-tube sets had inputs of only 100 to 120 mils, also, so you see I had good reason to feel surprised.) However, the only result of the check was a reaffirming of the values that had been in use and was forced to decide that the C battery represented a means of increasing the input and output of my set. This result was exactly what I

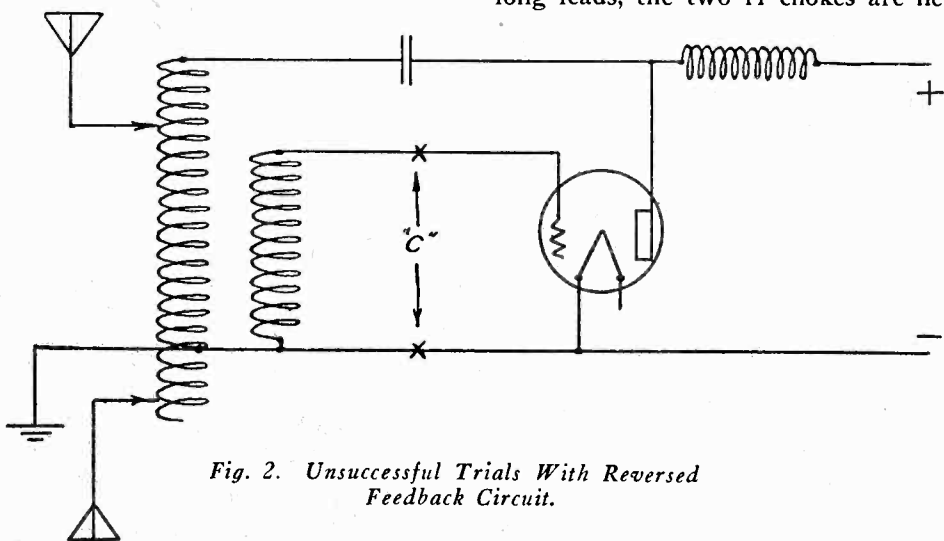

Fig. 2. Unsuccessful Trials With Reversed Feedback Circuit.

sary. If the two chokes are used, they should be mounted with at least 2-in. separation and at right angles. They can be made of very fine wire, No. 30 or smaller, and would preferably be wound on a 1-in. diameter form because of its compactness; 350 turns is the correct value. If you use a dry-cell battery cover, 300 turns, and if a 4-in. form, 250 turns. These chokes should be mounted with leads as short as possible to the condenser shunting the C battery. The 1-in. choke, by the way,

Continued on page 87

QUALIFYING FOR AN OPERATOR'S LICENSE

By KENNARD McCLEES

It is unlikely that anyone who is sufficiently interested in radio to wish to become a commercial operator will not have had some home or amateur experience. A wireless school course never takes the place of this, although it is often a necessary supplement. An ease of sending, a feeling of being at home with the key, as acquired through amateur practice, is never gained with the mechanical apparatus to be found in a school.

The chief value of a school lies in its equipment. Here the student may handle and thoroughly familiarize himself with the various types of apparatus of which he has only read. A school which is completely fitted with modern equipment should be selected; there should be at least one complete installation of modern quenched-spark transmitting equipment, an example of shipboard arc installation, and receiving apparatus of a commercial type for undamped waves, as well as the other commercial types of receiving apparatus.

Given good instructions to explain the foregoing, it will take the layman, with no experience, the best part of a year to qualify for a first grade commercial operator's license. The man with several years amateur experience can earn his ticket in perhaps half that time. The examinations are stiffer than they used to be, however, and a man must be able to practically build a set out of odds and ends as well as send and receive code at the required speed before he will be sent out on a ship with the lives of many people in his care and the safety of a valuable cargo depending on his ability to face emergency.

Many of the correspondence school courses promise more than they can possibly fill. They offer a six to ten weeks course with a two hundred dollar a month salary at the end of it, when it should be known that the ship operator who draws down ninety per is never a raw beginner. Also the radio inspectors quickly recognize a "question and answer" man, as these students are known, and do not look upon them with favor.

So the applicant who has worked with amateur transmitting equipment is that much ahead of the game, and the student who is just entering the game should install it as soon as possible. If electric lighting current is at hand this should not prove expensive as many parts can be put together from material that is either around or can be purchased at a low cost. A CW or vacuum tube equipment is to be preferred to spark as experience with the former is essential and the transmitting range is, of course, increased. A small buzzer set is an essential, as constant practice is needed and there is not someone always on the air

to work. Good sending does not come easily and a steady hand should be the aim of every tyro.

It will take about one hundred thousand words of practice sending to develop a fair hand. Several pages from a book or magazine should be sent on the buzzer set daily, and a slow steady gait must be the first object. Speed should not be attempted as, when tried early in the game, it invariably leads to a jerky, stuttering method of sending that can never be entirely lost. An excellent rule for speed is that which allows for no more than one break or mistake in every fifty and later, every hundred words.

Care should be taken to grasp the key-knob in a firm, but not tense, fashion. There should be no strain and no cramp and the best way to reach this desired condition while retaining a firm grasp is as follows; Place the key so that the entire forearm can rest easily on the table, the index finger falling on the knob with the second finger against the right-hand edge; now—the secret of good sending—the thumb must go under the rim of the key to the left, this gives a true grip on the key and leads one to avoid that mannerism called "tapping," which lacks the accuracy and roundness that is easily recognized in the expert who always handles his key this way. Remember to always space your letters evenly and to maintain an even speed as this is the true object of all your practice. A uniform method of sending will be certain to gain you your license, while individualistic mannerisms may hold you up indefinitely.

To turn to the receiving side of student operation it will be necessary to have something to listen-in on. A simple beginning is best and if the student is in or near a coastal city he will find many amateur and ship stations within

reach of a crystal detector set. The parts necessary are; a double slide tuning coil, or preferable a small loose coupler, a silicon or galena detector, a pair of phones, and a fixed or phone condenser. This modest beginning can be added to as his experience dictates and there are fewer parts to confuse him at a time when many dials will do more harm than good. Although these simple instruments can be largely constructed by anyone, the reliably made factory articles now obtainable will prove a valuable saving in time. No important experience is gained in making these parts as the method of construction can be seen at a glance and followed through in the mind.

With these parts wired up before him, he can listen in on the seemingly ceaseless amateur traffic going on about him and can undoubtedly find some beginner like himself who is interested in sending and receiving at a slow rate. If care has been taken to purchase a loose coupler which will receive as high as 800 meters, the shipboard and radio compass stations can be heard, and when familiarity with the code is gained an important knowledge of the way traffic is handled will come from studying their messages.

When the pocketbook admits the purchase of an audion tube this with some long-wave honey-comb coils should be the next addition as they will bring in the high-power arc stations anywhere in the United States. Much of this high-power transmission is carried on at a comparatively slow rate of speed, with many of the larger arcs on the air almost continuously. This affords the student practice at practically any hour of the day or night, and he has his choice of fast or slow code. The man who is able to copy this commercial telegraph

Continued on page 82

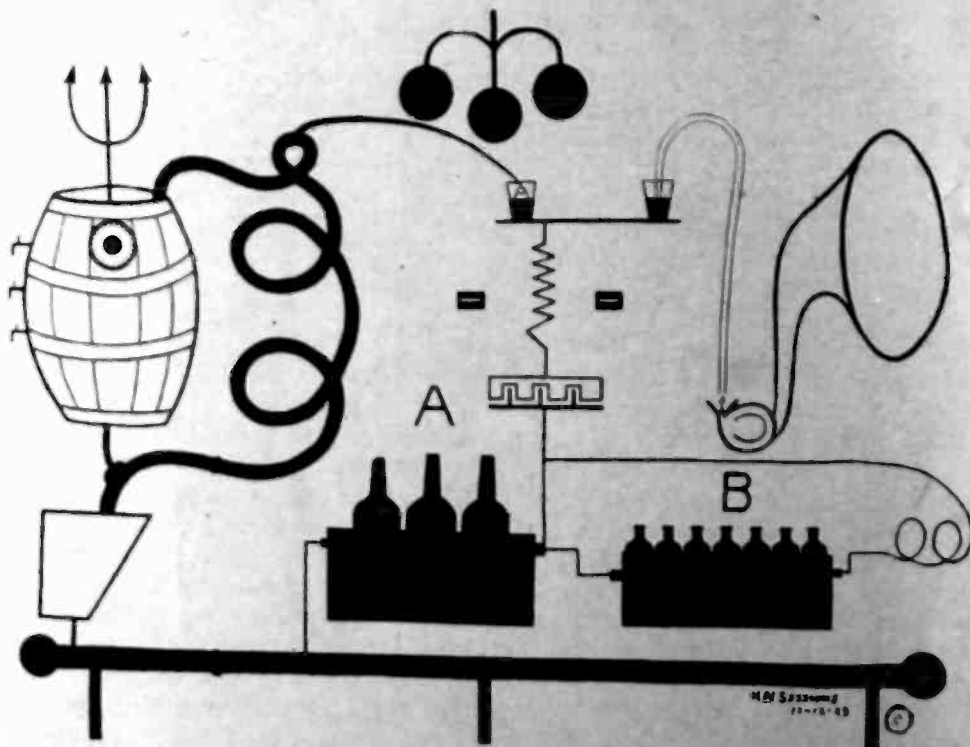

The Alcoholodyne Circuit Designed But Not Used by Harry N. Sessions of Los Angeles.

A Radio Set Trouble Shooter

A Convenient and Speedy Method for Detecting Hidden Defects in a Complete Receiver or Parts Thereof

By Sidney L. Goodwin and Arthur L. Smith

AS mysterious troubles may develop in a new or an old receiving set, the repair man must be prepared to diagnose the symptoms and prescribe the remedy. This is ordinarily done by a laborious testing of circuits and parts, involving much time. To expedite this work at their laboratories at Portland, Oregon, the authors have assembled a complete fault-finding equipment which gives the required data with a minimum of time and effort.

This test equipment has been conveniently assembled as shown in the accompanying illustration. The radio set under suspicion is merely placed in front of the trouble shooter and subjected to a series of tests which quickly locate the trouble.

The equipment consists essentially of five circuits, one for testing the continuity of the wiring in a receiver, another, including an oscillator and resonant circuit, for testing condensers and coils, a third audio frequency circuit for

testing loud speakers and audio frequency transformers, a fourth amplifier and wavemeter circuit, and a fifth comprising various convenient meter connections.

The first test circuit, shown at the ex-

treme right of the panel as illustrated, consists of six jacks and a meter switch whose general connections are shown in Fig. 1. These jacks may be connected by means of a cable and adapter plug inserted in each tube socket so as to test the continuity of the primary and secondary circuits and of the battery circuits and voltages. Fitting into these six jacks are three plugs connected respectively to a high voltage *B* battery meter, a low voltage *A* battery meter,

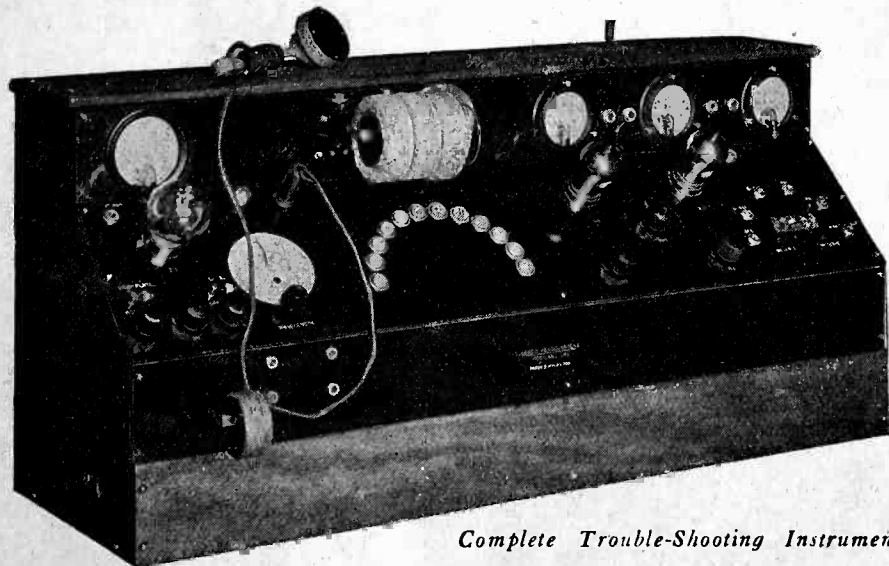

Complete Trouble-Shooting Instrument

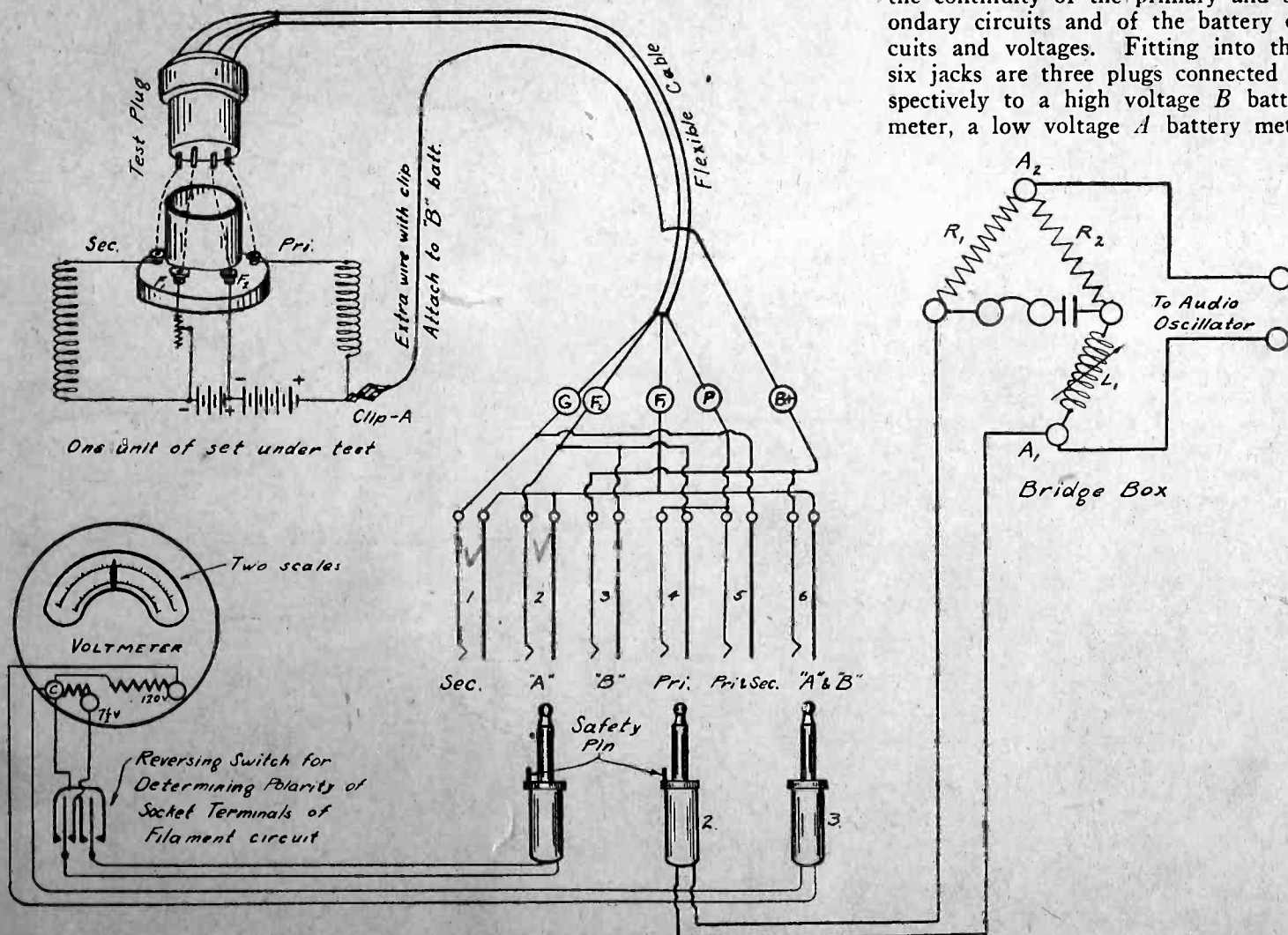

Fig. 1. Circuit for Testing Continuity of Connections.

and a bridge box. Associated with the plug cable is a clip *A* for connection to the positive *B* battery.

The first trouble looked for is possible short or open circuit in the wiring. By placing plug 3 into jack 5 and putting the adapter plug in the tube socket the circuit is established from the *B* battery positive thru the transformer primary, voltmeter, tube grid terminal, transformer secondary, *A* battery positive and negative to *B* battery negatives, thus giving a simultaneous check of the primary and secondary circuits with *B* and *A* batteries as energy source.

Inserting plug 3 into jack 6 indicates the combined voltage of the *A* and *B* batteries, also showing whether the negative *B* is connected to the positive *A*, or vice versa, if clip *A* is connected to positive *B*. Putting plug 3 into jack 3 gives the *B* battery voltage, proving the continuity of the circuit and indicating its resistance drop.

Inserting plug 1 into jack 2 gives the *A* battery reading and by throwing the reversing switch determines the polarity of the filament terminals of the socket.

Plug 2 is connected to a Wheatstone bridge contained within the cabinet, and also to an audio frequency oscillator. The bridge is made up of two variable resistances R_1 and R_2 , a variable inductance L_1 , and the primary or secondary coil of a transformer under test as the fourth or unknown arm. An input current supply from the audio oscillator to

be described later, may thus be passed thru the secondary by jack 1 or primary by jack 4, giving the impedance by the null method of balancing as checked by a pair of headphones. For the longer wavelengths, tested honey-comb coils may be conveniently connected in series with L_1 .

THE audio-frequency oscillator and associated equipment is shown in the sketch of Fig. 2. This is available not only for the transformer coil test already described but also for testing condensers, inductances and tubes. A

good idea of its action may be gained from the circuit diagram of Fig. 3.

This part of the equipment consists essentially of an "A" tube in a Hartley circuit with 45 volts *B* battery. Resonance at different wavelengths is secured by adjusting an inductance made up of

Continued on page 96

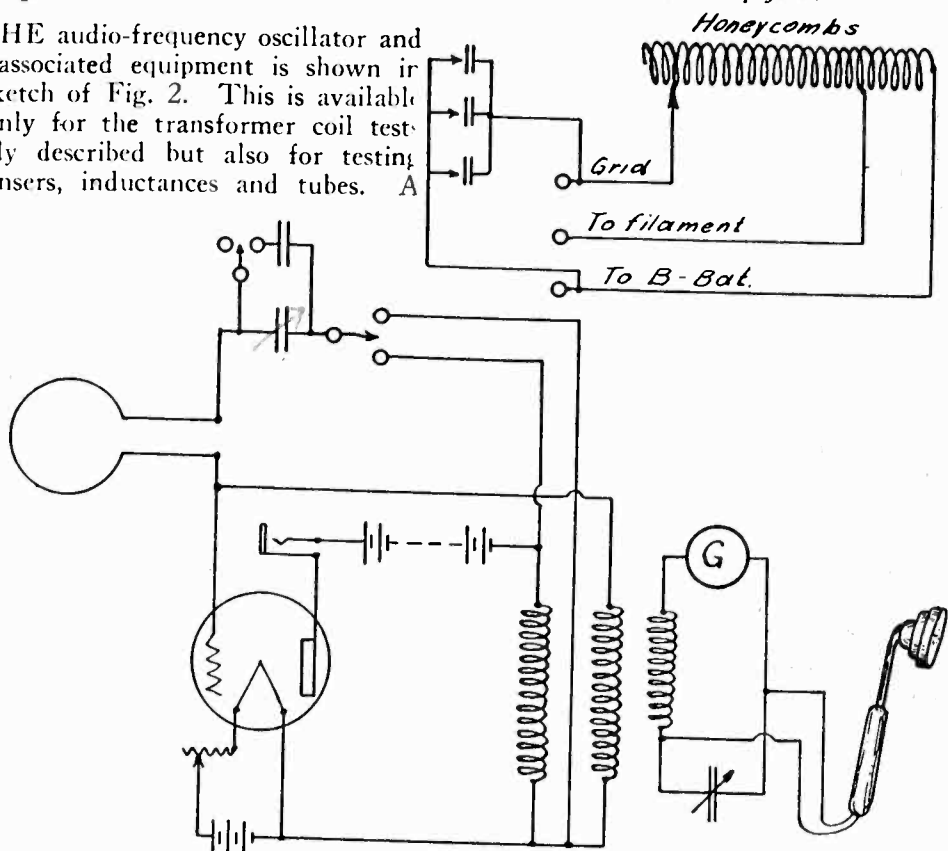

Fig. 3. Circuit Diagram of Audio Oscillator.

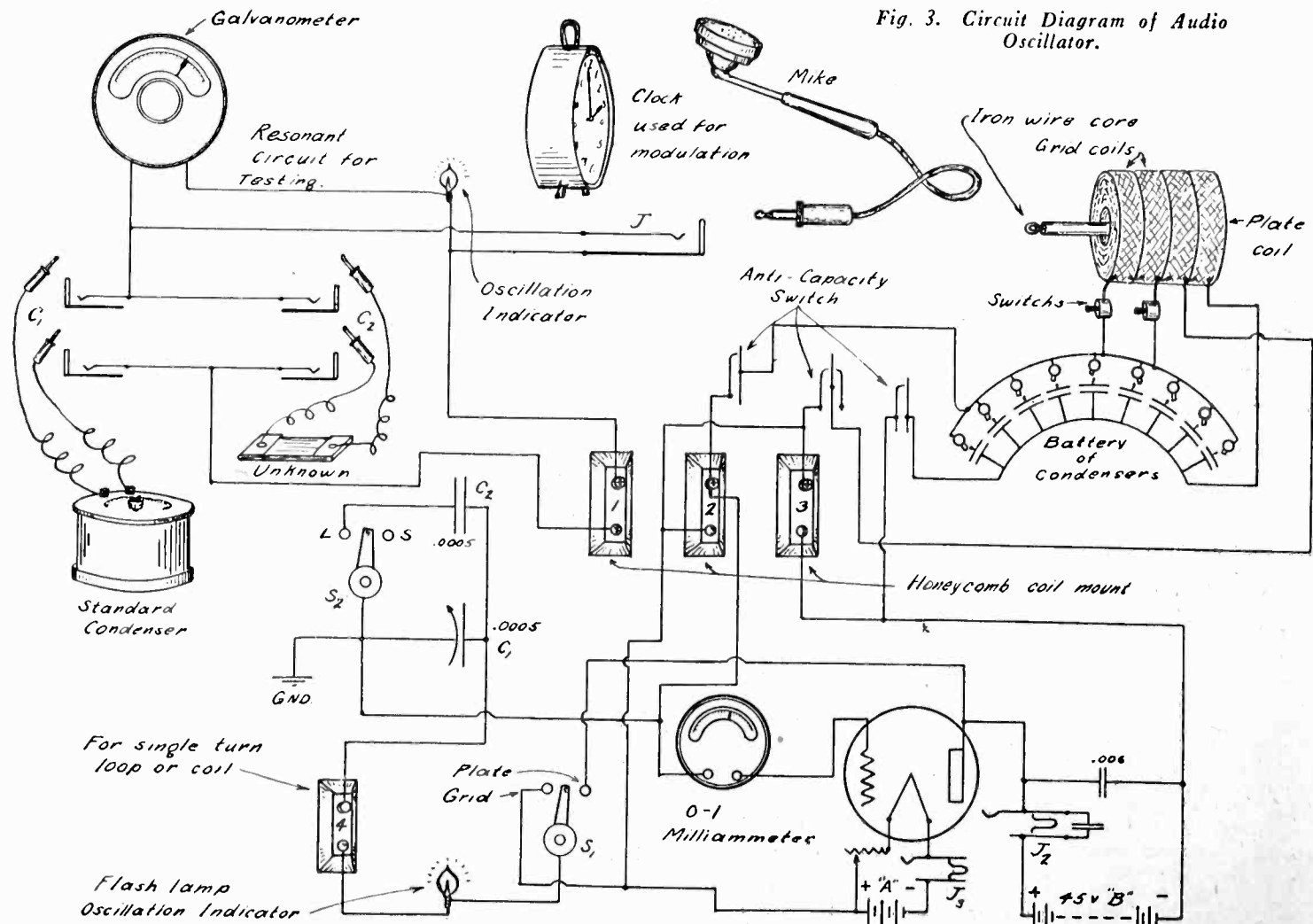

Fig. 2. Sketch of Audio-Frequency Oscillator Circuit.



QUERIES *and* REPLIES



Questions submitted for answer in this department should be typewritten or in ink, written on one side of the paper. All answers of general interest will be published. Readers are invited to use this service without charge, except that 25c per question should be forwarded when personal answer by mail is wanted.

Please publish the circuit using two stages of radio frequency amplification, crystal detector and one stage of audio frequency, with WD-11 tubes. I intend using only a variable condenser for tuning.
—G. B., Pittsburg, Pa.

The secondary coil, in two sections, consists of 6 turns of No. 16 DCC wire for the first, and 12 turns of the same wire for the second parts, respectively, wound basket fashion on a diameter of $3\frac{1}{4}$ in. The tickler coil consists of 11 turns of No. 16 DCC wire,

minimum at all times, for consistent results. As musical quality is not desired in this receiver, a very high ratio audio frequency transformer can be used, as most transformers of high ratio are resonant at 1,000 cycles, and will give high amplification at that

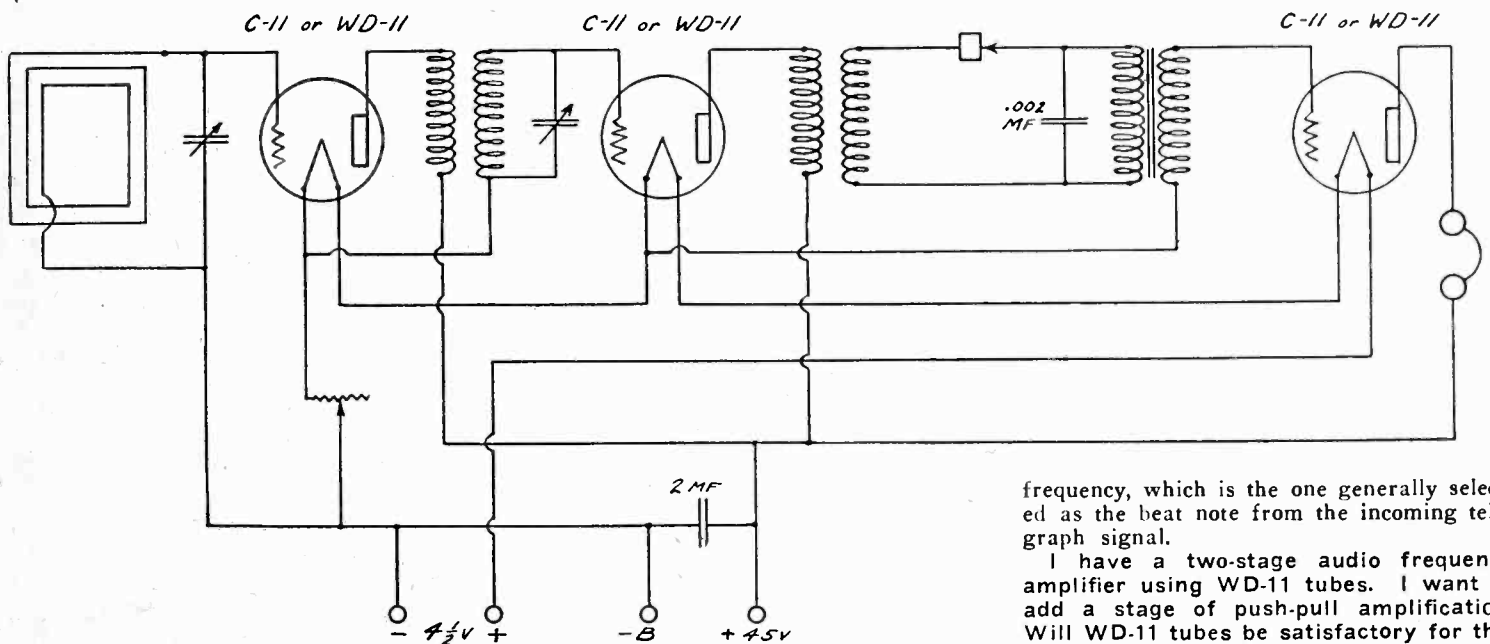

Fig. 1. Circuit Diagram for Two R. F., Crystal Detector, and One A. F.

A diagram for the circuit connections you wish is shown in Fig. 1. If you intend to use only one variable condenser for tuning, it will be necessary to employ a loop antenna, as a single condenser would not be sufficient for tuning an outdoor antenna. A series arrangement of the three filaments is shown, to avoid the use of C batteries. It will be necessary to have a $4\frac{1}{2}$ volt dry cell battery to accommodate the three tubes, and only one filament rheostat is necessary.

Kindly publish a hook-up for a very short wave receiver, for 50 to 125 meters, preferably with tuned radio frequency amplification.

—F.P.W., San Luis Potosi, Mex.

Most American amateurs find the regenerative non-radiating type of receiver the most satisfactory for the very short waves, although some success has been attained with the super-heterodyne circuit. Coupled to a good short wave antenna, a receiver consisting of a detector and one stage of audio frequency amplification should enable you to hear all the American and Canadian districts, and some European and Australian amateurs. A circuit diagram of a good receiver of this type was published in April, 1924 RADIO, but is being revised and again printed in Fig. 2. The antenna coil consists of 5 turns of No. 16 DCC wire wound in basket form, to a diameter of $2\frac{1}{2}$ in.

wound on a $2\frac{1}{4}$ in. diameter, and made variable with respect to the secondary. The primary coil should also be variable with respect to the secondary, and on the opposite side of the secondary from the tickler. The antenna coupling should be kept at a

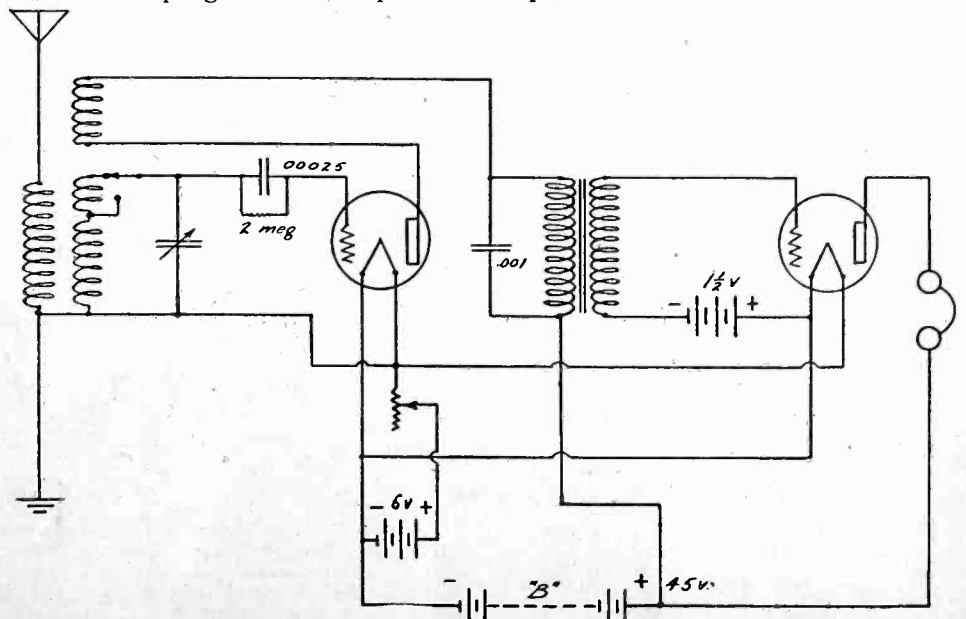

Fig. 2. Short-Wave Receiver.

frequency, which is the one generally selected as the beat note from the incoming telegraph signal.

I have a two-stage audio frequency amplifier using WD-11 tubes. I want to add a stage of push-pull amplification. Will WD-11 tubes be satisfactory for this purpose? Is the Meyer dry cell tube a good radio frequency amplifier?

G. L., Sebastopol, Calif.

Yes, provided that you operate the push-pull stage with at least $4\frac{1}{2}$ volt C battery and 90 volts plate. The Meyers tube will give excellent results in a radio frequency amplifier.

Please publish a circuit adaptable to a G. E. double current aviation generator, for short wave transmission.

—E.J.H., Brownsville, Ore.

Fig. 3 shows the circuit diagram for a 5-watt reversed feedback transmitter, for

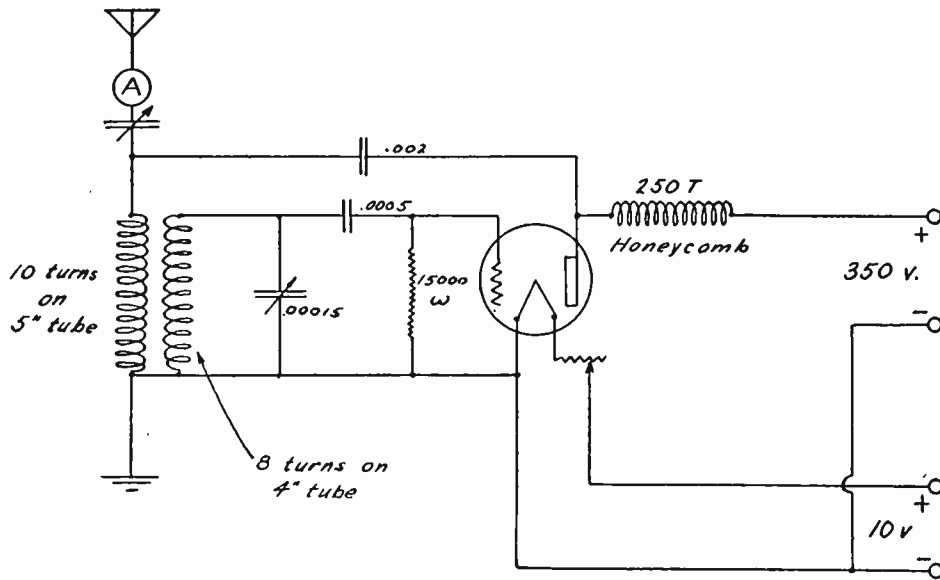

Fig. 3. 5-watt Reversed Feedback Transmitter.

C. W. telegraph purposes. As there are several types of aviation generators, we are assuming that you have one of the small sizes.

Will Branston parts work satisfactorily in the Best 45,000 cycle Super-Heterodyne circuit published in May, 1924 RADIO? Can UV-201-A tubes be used in this circuit?

—P.E.W., San Francisco, Calif.

Yes, Branston parts will be O. K. UV-201-A tubes can be used, but it is doubtful if the results will be sufficiently better than the dry cell tubes, to warrant the battery expense. The large tube will be better in the last stage of audio frequency amplification, as it will handle a greater amount of power than the UV-199 tube. If UV-201-A tubes are used in the intermediate stages, a potentiometer will have to be used to prevent oscillation, unless elaborate shielding is placed around the transformers.

What is the most economical and efficient circuit for four UV-199 tubes, to give satisfactory loud speaker operation, with reasonable distance.

—H.L.R., Oakland, Calif.

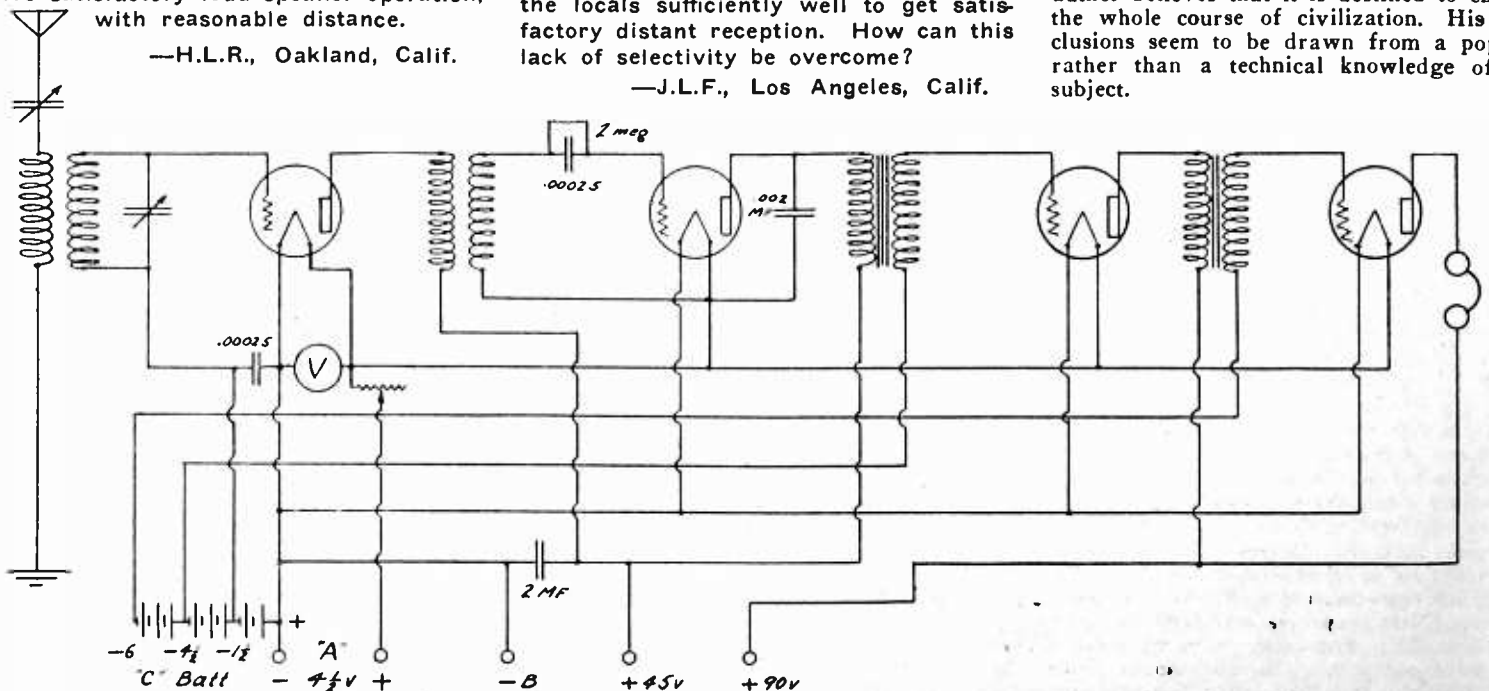

Fig. 4. One Stage R. F., Detector and Two A. F.

Fig. 4 gives the circuit data for one stage of radio frequency amplification, detector and two stages of audio frequency amplification, for UV-199 tubes. The tuner should include a varicoupler and two air condensers, if any degree of selectivity is desired.

The antenna coil is too closely coupled to the secondary for good selectivity. This close coupling was due to the desire to eliminate as many controls as possible, but the scheme does not work out in congested localities such as yours. It would be better to substitute a variocoupler for the first coil in the set, and tune both the rotor and stator of the coupler with air condensers. The rotor should be placed in the antenna circuit, with sufficient series inductance, such as a 50 turn honeycomb coil, to enable you to tune through the entire broadcast wave band. Additional adjustments are introduced, to be sure, but you will certainly be able to cut out any or all of the local stations when receiving distant stations.

My audio frequency amplifier, which is two stages of 3:1 transformer-coupled, has a high frequency howl in it most of the time, which I cannot cut out. How can I overcome the trouble?

—V.L.H., Norfolk, Va.

Try the following remedies, in succession: Shunt a 1/2 megohm grid leak across the secondary of the second transformer; connect the cores of the two transformers to ground; tie the grid of the last tube to the negative filament through a .00025 mfd. fixed condenser; place the transformers so that the cores are at right angles to each other, in case they are unshielded types. It would also be well to make sure that you have the grid and plate of each tube connected to the proper terminals on the transformer, as designated by the manufacturer.

BOOK REVIEW

"Practical Radio" by James A. Moyer and John F. Wostrel, 250 pp., 5x7 1/2, published by McGraw-Hill Book Co., New York City. Price \$1.75.

The purpose of this text is to give an understanding of the how and why of radio reception in terms that will be intelligible to the novice. In addition to their explanation of the theory the authors have presented working drawings for several types of receiving sets. This latter information is sufficient to enable the reader to construct his own set. A commendable feature is the set of questions at the end of each of the thirteen chapters. The wiring diagrams are especially well drawn and show most of the popular sets of the day.

"Wireless Possibilities" by A. M. Low, 71 pp., 4 1/4 x 6 1/4, published by E. F. Dutton & Co., New York City. Price \$1.00.

This book, as one of the "today and tomorrow series," discusses the future of radio telephony, radio vision and tele-control. The author believes that it is destined to change the whole course of civilization. His conclusions seem to be drawn from a popular rather than a technical knowledge of the subject.

—J.L.F., Los Angeles, Calif.

Letters to The Editor

The 2,000-Mile Reflex

Sir: I submit the wiring diagram for a set that I find to be more sensitive and selective for local and distance work than the new 3-tube Harkness hook-up. The secret is in the feedback as controlled by the potentiometer or stabilizer.

Any fans who are interested can have blue prints and full instructions for almost

amateur on the 25 turns coil. The stations tuned in so far are KHJ, KFI, KNX, KFSG, KJS, KFON, KGO, KLX, KPO, KOB, KFKX. The tone is as perfect as any of the so-called better sets and volume very loud for house using Baldwin unit on fibre (cheap) horn. KGO comes in through local broadcast with no interference and no trouble to tune in. I use 102½ volts on

several other set owners with sets not capable of receiving same who could each write in from hearing selections over some particular set.

The stations have probably thought of this feature, and any unusual record would naturally come under suspicion. I have at hand a dealer catalog plainly stating a 3,000-mile range for Fada 185-A, whereas Fada company booklet plainly states a 1,500-mile range

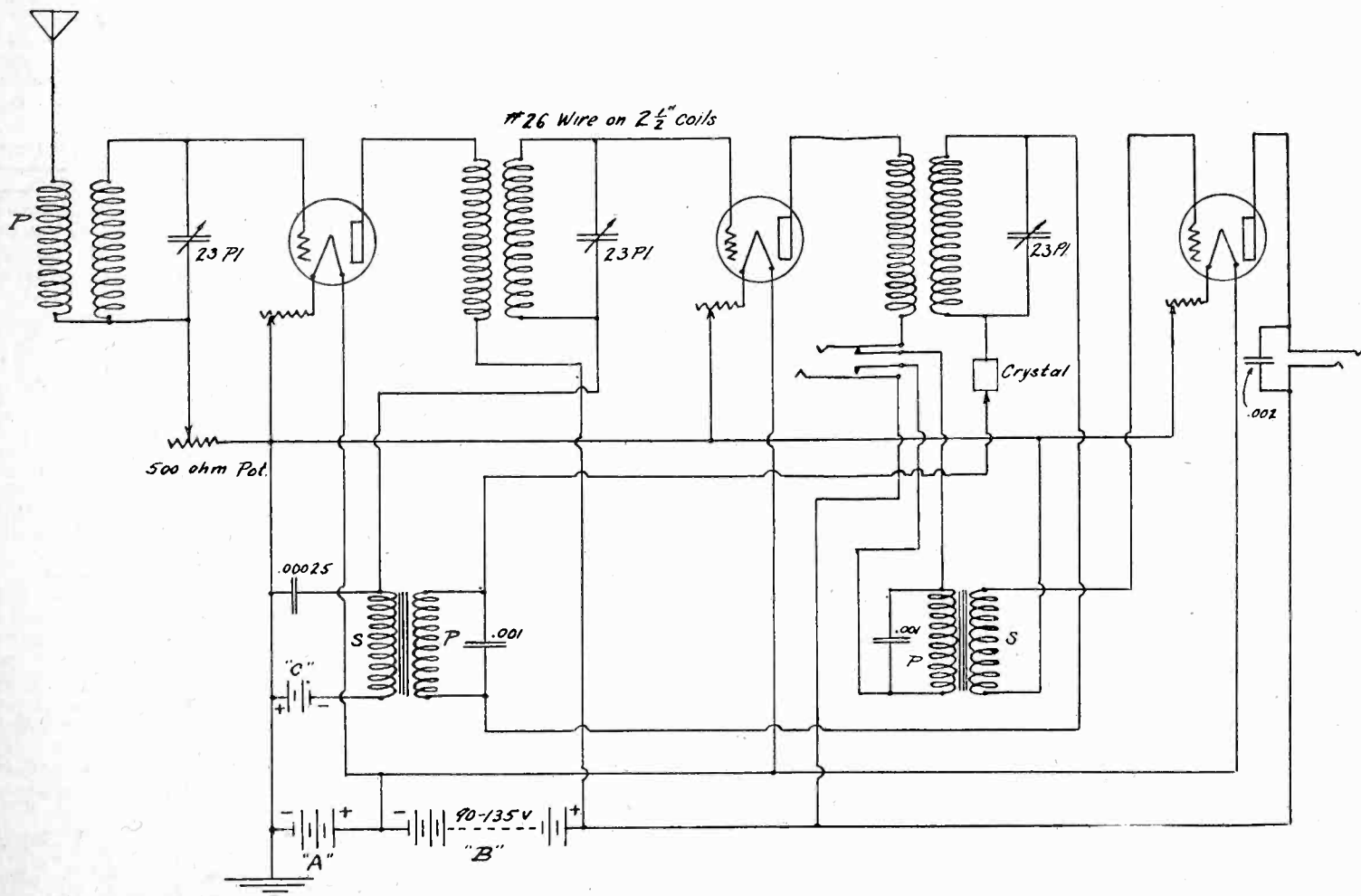

Bob White's 2000-Mile Reflex

nothing by writing to me. I looked long and hard for such a hook-up and then had to work it out for myself. It cuts through five big stations and brings in Portland clear as a bell.

ROBERT L. WHITE
4663 Maplewood Ave. Los Angeles, Calif.

Okeh's Griffin Set

Sir:—Having made up set for radio frequency ahead of regenerative, according to article by E. E. Griffin in RADIO for September, 1924, thought possibly the following would be of interest. I placed the honey-comb coil connectors on the panel outside of set and included one stage of audio frequency amplification instead of two, as in our location distance outside of KGO and other San Francisco stations is all one would want on loud speaker. On amplification of the circuit I find that the 50 turns coil will not cover the broadcast band. Using a 35-turn honey-comb I get wavelengths 312 and under excellently; 50 turns above 312 to about 400 and use 75 turns for the higher wavelengths. In other words, KFON, KFSG and KGO come in best with 35 turns, KHJ, KNX and KPO come in best with 50 turns, KFI and KLX best with 75 turns coil. I also have a 100 turns and 25 turns. Code comes in on both excellently. Not knowing code, cannot tell which is which. Hear

amplifier plate and 67½ on detector. Use .0003 phone condenser, which gives better results on distance—UV-301a tubes throughout variable leak. I have tried several hook-ups, but so far find this about the best of all for tone and distance together and highly recommend it to anyone with a single tube regenerative who wishes to cut down squealing and wants better tone and distance. I find that tuning is not difficult and that the circuit altogether would satisfy the most critical. I appreciate the article, as it has finally got me satisfied so that I don't pull my set apart every other day.

Yours very truly,

H. G. PEARCE.

4360 So. Main St., Los Angeles, Calif.

Verification of DX Reception

Sir: Re Mr. Croft's letter saying never again would he express applause of reception to radio stations.

My interest in this subject is purely as a listener. I have often wondered how any station could verify to their satisfaction that applause writers were entitled to credit of receiving their particular station, since stations have no way of knowing what set this program was received through, or who was the proper owner of the set that picked up the program which might be overheard by

is the best any of their sets will cover. My Fada 160 is rated by company at 1,000 miles range, and yet I received loud speaker reception 50 per cent of time from California stations (weak but clear) at an approximate distance of 2,400 miles from here. My test station on loud speaker to ascertain if outfit is functioning 100 per cent is KGO at Oakland.

I wish to state here that I have written applause cards to distant stations all over the United States and Canada, and while not enclosing postage, have at all times received courteous replies and verification letters. Defense Day night, several small set owners here thought they had heard Juneau. What they really heard was Washington, D. C., broadcasting telephone conversation with Juneau. Considering the above, we must realize, while sympathizing with Mr. Croft from his side, that the broadcasters have their side also, and are undoubtedly imposed upon at times. My experience is that it is unfair, if one wishes to be just, to doubt a statement of reception without knowing more about it.

It takes all kinds of people to make a world, and some try to be humorous through sarcasm which should not be taken seriously.

Cordially yours,

A. H. KLINGBELL.

Ashtabula, Ohio.

An Experimental Hook-Up

Sir:—Herewith is a hook-up which I have not seen published and which might be of interest to advanced experimenters. It isn't the easiest thing in the world with which to obtain stable operation, but at times it works beautifully. The coupling devices are a fixed coupler and an 18° coupler, both having untuned primaries. ("Teledyne" coils work nicely with this arrangement).

It might be well to try a fixed by-pass condenser across the primary of the audio transformer which is in series with the plate of the first tube; also it is interesting to connect the phones at the point marked "X" and note the results.

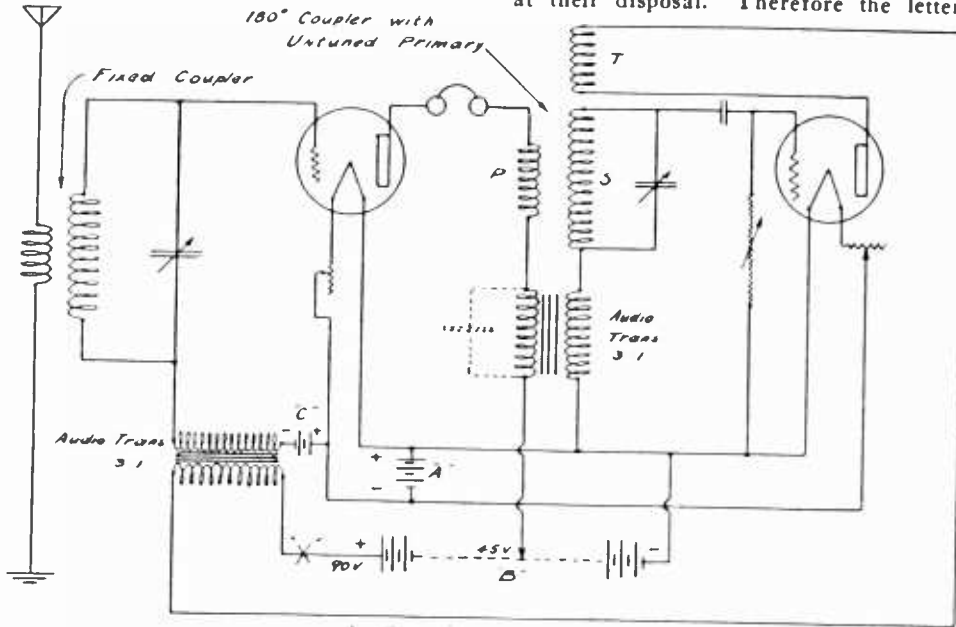

An Experimental Hook-up.

This circuit can be connected up with most any kind of coupling devices the experimenter may have on hand. One thing that has helped the writer to get the most satisfactory results has been to use a negative grid return on the detector tube—a soft tube being used in this instance, with 22½ volts on the plate.

This isn't a circuit for a beginner's first hook-up; however, it is one that may furnish considerable interesting entertainment and some valuable information to one sufficiently advanced to understand what to expect of it. The honey-comb coil with untuned primary, as described in my letter appearing in your August number, does very

well in this circuit; a tickler can easily be added to produce regeneration in the case of the coupler preceding the second tube. Both positive and negative feedback may be tried out with this arrangement.

Yours very truly,
C. M. DELANO.

Lincoln, Neb.

More Light on the Inadequacy of Resistance Coupled Amplification

Sir:—The writer is one of those who wrote you several months ago in defence of resistance coupled amplification, that is, for those having 300 to 400 volts direct current at their disposal. Therefore the letter on

engineer, nor is he in the business; but it is not a well known fact that for faithful preservation of the waveform impressed on the grid, that the grid bias voltage must be held at a well chosen point in order that the voltage variations on the grid will not overstep the straight line portion of the grid-voltage plate-current characteristic? Under this straight line condition it seems that the variations in the plate current results in an alternating current equivalent in waveform to the impressed grid voltage. Furthermore, the "zero line" of this complex alternating current is set at the plate current value corresponding to the bias voltage at which the grid is held.

A direct current milliammeter placed in the plate circuit of a properly adjusted amplifier tube stands perfectly still at a plate current value corresponding to the grid bias voltage of the tube. The needle of the meter does not jump because the audio frequency alternating current is of a very high frequency compared to the natural period of the meter armature and needle and other damping factors. Therefore the needle cannot follow the alternating current: an impulse downward on the scale is immediately counteracted by an impulse upward as far as the needle is concerned.

One of the most precise ways of testing for distortion within the tube and eliminating it is to place a sensitive direct current milliammeter in the plate circuit and observe its action when the loudest signals are being received. If any "dancing" of the needle is indicated, then the grid bias and possibly the plate potential needs adjusting. Raising the plate voltage and making a corresponding adjustment of the grid bias and grid leak valves are sometimes necessary. Plotting a curve is helpful. The plate resistors should be of large enough size to remain of constant resistance. If the milliammeter still persists in jiggling, it is possible that the amplifier tube is defective, or more than likely the tube is too small to take care of the "swings" of the grid voltage. A more powerful tube should be substituted; one which will maintain the linear relation between the grid voltage and plate current, even under the loudest possible signals. This point is too often overlooked in the ordinary garden variety of amplifiers.

Now, if Mr. Bouck's amplifier, as he says, "modulates" the plate current downward to a fraction of its quiescent value when amplifying an impressed signal, then is there not something wrong with the set-up of the amplifier? First of all, even when using the

Continued on page 88

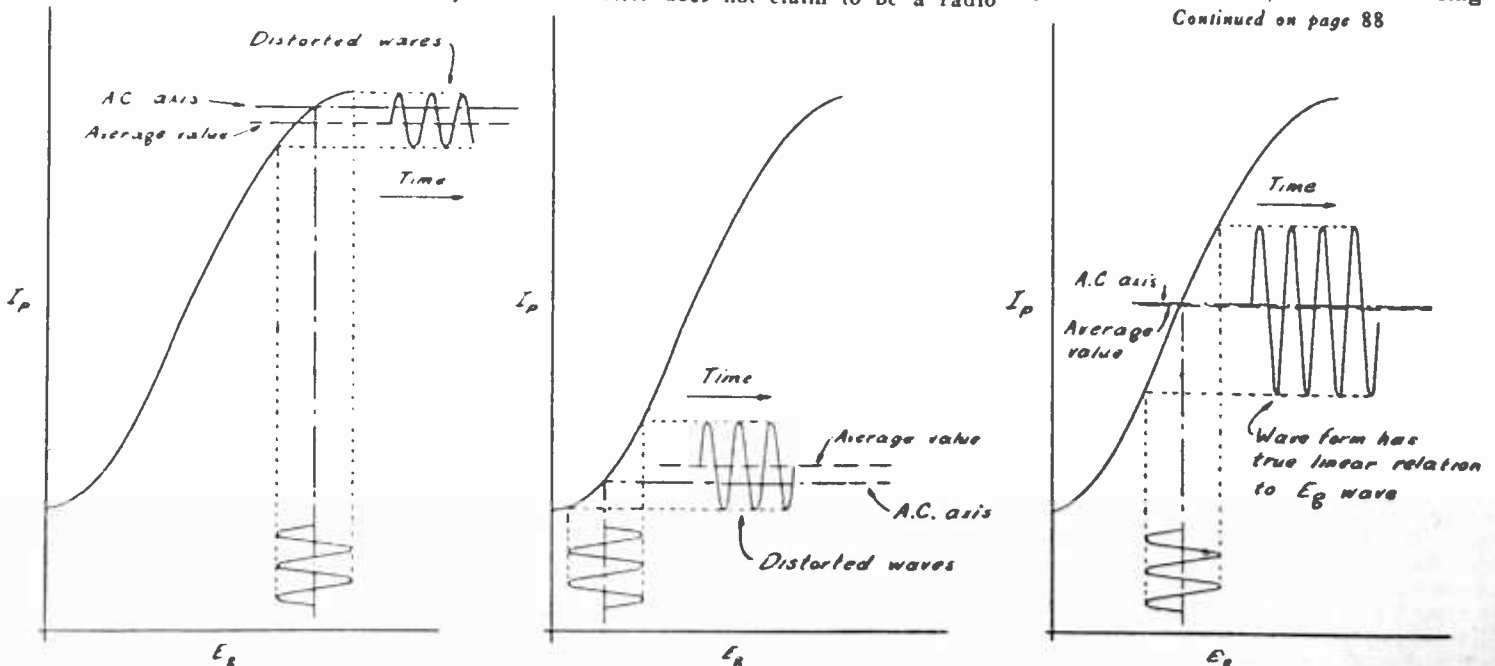

Grid Too Positive. Milliammeter Will Dip on Loud Signals

Effects of Various Grid Potentials
Grid Too Negative. Milliammeter Will Jump Up on Loud Signals

Grid O. K. A. C. Axis and Average A. C. Values Coincide. Milliammeter Steady on Loud Signals

With the Amateur Operators

RADIO STATION 6BBQ

Radio 6BBQ is owned and operated by Frank F. Macik, at 194 S. El Molino avenue, Pasadena, Calif.

The receiver which is in the center of the picture is a low loss in the left cabinet and detector and two step in the other cabinet. Most of the "ham" work is done on detector alone.

The transmitter is a 5-watt set using the 1DH circuit. This set is one of the few 5-watt sets which have been heard in New Zealand.

Using 500 volts on the plate through a

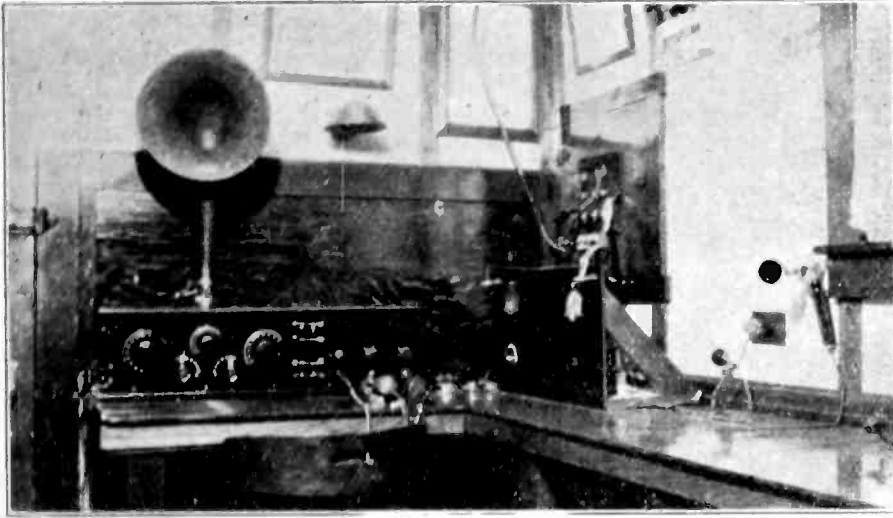

Radio Station 6BBQ.

20-jar rectifier and 7½ volts on the filament, the set radiates only one ampere at most times. The radiation at this station does not hinder the DX or worry the operator. The DX of the station on 5 watts is 27 states, all districts, Yukon, Canada, and heard twice in New Zealand.

A 50-watter has just been completed, but is not shown in the picture. The entire station is home-made and is housed in a special built 12x15-ft. shack. This is an O. R. S. station and the operator is the city manager for the A. R. R. L.

Phone is also used at times on the 5-watter and 500 miles is an easy occurrence.

The antenna is 60 ft. high and 50 ft. long, being an inverted L, and the lead comes right down to the shack. This station is equipped with a wave meter calibrated with a General Radio wave meter. A check on waves as near as possible is always gladly given.

November DX At 6XAD-6ZW

Stations worked: 1axa, 2kk, 2rk, 2cxy, 2acs, 2cyq, 2eqo, 2ach, 2ccu, 3hg, 3ckl, 3lg, 3edu, 5kr, 5akq, 6oa (Honolulu), 7ok, 7dd, 7ao, 7ku, 8afn, 8mc (works me from Rochester, N. Y., with one 5-watt tube—FB!), 8doo, 8aly, 8ben, 8boe, 8ced, 8bzf, 8dki, 8sf, 8chp, 8doi, 8lga, 8boe, 8cwu, 8lga, 8ay, 8ese, 8axf, 8ckm, 8dal, 8bch, 8anb, 8bqf, 8bau, 8dfm, 8sfo, 8bzf, 8bdu, 8aly, 8cbp, 9lz, 9ejm, 9dhg, 9eky, 9rc, 9ws, 9afp, 9aid, 9alm, 9eam, 9djn, 9awg, 9dau, 9ro, 9bre, 9ejm, 9dhg, 9cy.

Stations reporting: 1aed, 1btt, 1bc, 2le, 2epa, 2fc, 2cxn, 2ags, 3dq, 3ke, 3bjm, 8bgn, 8cip, 9hp, 9ahl, 9diq.

Major Mott is transmitting ICW on 60 meters with one W. E. 250 watt tube putting 6 amps. into a 43-ft. 4-wire vertical cage aerial as well as with one 500-watt transmitter on 168 meters. A 3 kw. tube will be on the air soon on low waves. His station will be silent during January and part of February while he is fishing in Florida.

NEWS OF THE AMATEUR OPERATOR

6BBV has moved to 1511½ No. Commonwealth, Hollywood, Calif.; 100 watts on 40 and 80 meters; glad to qsr; pse qsl.

6BPO, M. O. Smith, 504½ N. Adams, Glendale, Calif., wants qsl's.

5CU has been issued to R. H. Robinson, 412 Park Place, Ponca City, Okla., 200 watts self-rectified C. W., will qsr.

5ZAV and 5AIU, Lee Moffatt, Jr., and Dan Howard, 824 So. Elm, Norman, Okla., are again on the air on 80 meters.

2HE has been assigned to M. Luptem, 365 New York Ave., Brooklyn, N. Y.

8BFG is Edward Roberts, Skaneateles, N. Y.

6BCH, Vernon L. Harvey, has moved to 1140 So. San Joaquin St., Stockton, Calif., 10 watts C. W., 1 C. W. and phone; pse qsl.

6CM has been re-issued to the San Diego High School, San Diego, Calif., formerly 6AWQ; schedule Mon. and Wed. nights, 5, 10, 20, 50, 100 watts, 1 C. W., C. W. and phone; glad to qsr and will qsl.

6BSC has been reassigned to C. E. Gulick, R. D. No. 3, Orange, Calif.

8ZE-8GX (6AWP) is on 78 meters with 50 watts in Meissner Circuit and would appreciate reports on signals. Will be glad to QSE to all stations on receipt of their station card. All cards answered.

The following calls were heard on the 75-80 meter band and on about 85 meters at the localities indicated. Further details will be furnished amateurs listed who write the editor.

November 3-4, near Yokohama, Japan, aus 3bq, nz 2ac, nz 4aa, nz 4ak, 6aao, 6abc, 6agk, 6ahp, 6arb, 6bql, 6cgo, 6lj, 6of, 7fd.

November 10-11, at Kobe, Japan, nz 2ac, nz 4aa, nz 4ag, 6agk, 6apw.

November 12, in the Inland Sea, near Moji, Japan, aus 2cm, aus 3bq, nz 4aa, nz 4ag, nz 4ak, 6age, 6ahp, 6bdt, 6cej, 6cto.

November 14, in the Yellow Sea, near Dairen, Korea, aus 2yg, nz 2ac, nz 4aa, nz 4ak, 6akz, 6awt, 6bcp, 6bql, 6cgo, 6zp.

6CGW worked New Zealand station Z4AA and reported 4AA's signals fairly strong and steady.

A number of west coast stations have worked New Zealand stations with fair regularity. The most reliable New Zealand stations are 2AC, 2AK, 4AA, 4AK and 4AG. Each of these stations has been reported

Continued on page 76

CALLS HEARD



By Albert E. Searlett, Jr., 23 Cooley Place, Mount Vernon, N. Y.

1aur, 1awq, 1bjf, 1btt, 1bub, 1kx, 1yd, 3bfe, 3ckl, 4bl, 4bq, 4ft, 4hs, 4io, 4ku, 4ly, 4mi, 4oa, 4pl, 4rr, 4sa, 4xe, 4xx, 5agl, 5ags, 5ajh, 5alz, 5dw, 5gk, 5hl, 5jh, 5mi, 5oh, 5ph, 5qh, 5tq, 5ua, 5uk, 5wy, 5xv, 6age, 6apw, 6bez, 6bjx, 6blw, 6bra, 6bur, 6cel, 6ajf, 6cej, 6cgo, 6cgv, 6cng, 6fy, 6lj, 6lv, 7abb, 7eo, 7gr, 7ij, 8aa, 8abn, 8ade, 8aey, 8afn, 8afs, 8aft, 8ajd, 8ajf, 8ajn, 8alf, 8aly, 8apt, 8arn, 8aro, 8aru, 8asq, 8atp, 8atz, 8aub, 8afx, 8axn, 8ay, 8ba, 8bau, 8bce, 8bcp, 8bda, 8bdb, 8bdw, 8ben, 8bhj, 8bhu, 8bkh, 8bkm, 8bml, 8bnh, 8bni, 8boe, 8boo, 8boy, 8bp, 8bpa, 8bpl, 8bpy, 8bqp, 8bqr, 8br, 8bst, 8btf, 8btu, 8bvr, 8bxh, 8byn, 8bzf, 8cbm, 8cci, 8ced, 8ceo, 8cep, 8ces, 8cko, 8ckt, 8cmi, 8coj, 8cse, 8csn, 8cta, 8cvi, 8cvt, 8czy, 8dal, 8dat, 8ded, 8dfm, 8dfo, 8dga, 8dgp, 8dha, 8dhd, 8dhw, 8div, 8djp, 8dki, 8dmf, 8dnf, 8dnk, 8dpk, 8dpp, 8dpy, 8dqv, 8dse, 8eb, 8ef, 8fs, 8ju, 8jz, 8or, 8pu, 8pz, 8rj, 8rv, 8sf, 8sy, 8tt, 8tw, 8ut, 8vc, 8vy, 8xs, 8zf, 8zy, 8zz, 9aad, 9aal, 9aau, 9aav, 9abf, 9aci, 9ado, 9afu, 9afy, 9agl, 9ahj, 9ahq, 9aio, 9and, 9aor, 9apg, 9apy, 9ars, 9ato, 9auy, 9avb, 9axh, 9axt, 9bau, 9bbj, 9bbr, 9bbw, 9bcb, 9bcd, 9bdq, 9beg, 9bf, 9bie, 9biq, 9biu, 9bjp, 9bki, 9blg, 9bm, 9bmc, 9bmf, 9bmh, 9bmk, 9bna, 9bnk, 9bpm, 9brx, 9bso, 9bsp, 9bvw, 9bwp, 9bww, 9ca, 9cap, 9cau, 9ccm, 9ccx, 9cee, 9cek, 9cep, 9cfs, 9cgn, 9cgr, 9chx, 9cii, 9cjc, 9ckl, 9clq, 9clx, 9cmc, 9cp, 9cro, 9ctr, 9cxs, 9dac, 9dbj, 9del, 9dfz, 9dhl, 9dij, 9dlj, 9dlw, 9dno, 9doa, 9dpl, 9dpr, 9dqu, 9duj, 9dwx, 9dwz, 9dxn, 9dyy, 9eby, 9edb, 9edh, 9ef, 9efz, 9ejl, 9ejx, 9ejy, 9ek, 9eky, 9ela, 9elb, 9ely, 9em, 9hk, 9lz, 9lp, 9mn, 9my, 9ny, 9oa, 9qi, 9rt, 9tw, 9ut, 9vc, 9vz, 9xl, 9xm, 9xw, 9yb, 9zb, 9zt.

Canadians: 2am, 2ax, 2be, 2cg, 2fj, 2hv, 3aa, 3ad, 3gv, 3he, 3ly, 3xl, 3zl, 9bb.

Commercial: nfv.

All heard on 1-step Audio, using 80-ft. indoor antenna.

Stations Worked at 2CNK, 255 West 108th St., New York City

4ab, 4gf, 4jr, 4ft, 4qw, 5gj, 5tj, 5xa, 8bsu, 8rt, 8vq, 8aa, 8apn, 8bbf, 8hp, 8btp, 8dgp, 8anf, 8amp, 8bvr, 8apt, 8qr, 8wz, 8amq, 8dpl, 8dof, 8cm, 8cpi, 8bgn, 8ku, 8bdw, 8cjp, 8xhc, 8rv, 8ben, 8cel, 8amq, 8dcr, 9efz, 9auc, 9aud, 9ccv, 9blf, 9bwp, 9arj, 9azx, 9bnk, 9dxy, 9ep, 9bbj, 9ahq, 9del, 9hp, 9kq, 9akn, 9lw, 9drs, 9dpc, 9ejl, 9ahy, 9hr, 9alc, 9bay, 9vc, 9dix, 9col, 9cve, 9ceb, 9ejc, 9dug, 9hwz, 9ccn, 9biq.

Will be glad to QSR cards to those who desire.

At 2WZ, 654 East 23rd St., Brooklyn, N. Y.

4al, 4bq, 4bx, 4ch, 4fs, 4ft, (4hr), (4jr), 4kk, 4ml, 4oa, (4pd), 4qf, 4rf, 4rr, 4ru, 4sl, (4tj), 4xe, 5al, 5fv, 5tn, 5jf, (5ka), 5mi, 5ph, (5qh), 5tn, 5uk, 5xa, (5aaq), 5acm, 5aex, 5air, 5alj, 5aqr, 5xt, 5zal, 5zas, 6gt, (6gu), 6jp, 6lv, 6rn, 6aab, 6aao, 6adt, 6agk, 6avj, 6awt, 6bjj, 6bka, 6bur, 6buy, 6cfz, 6cgs, 6cgv, 6chx, 6cge, 6cex, 6cto, 6xad, 7gq, 7zu, 9ab, 9bk, 9ca, 9ep, 9hn, (9hp), 9il, (9kq), 9lb, (9mc), 9ny, 9pb, 9rt, 9vc, (9xi), 9zw, (9aad), 9aav, 9acl, 9adp, (9afi), 9afy, (9ahe), 9aod, 9aor, 9aps, 9ars, 9att, 9aur, 9avb, 9aws, 9axt, 9axx, (9bbj), 9bcd, 9bdw, (9bge), 9bez, 9bga, 9bhf, 9bhy, (9bhx), 9bie, 9big, 9bjl, 9bhm, 9bmy, (9bna), 9bnk, 9bob, 9bpo, 9bud, 9bva, 9bxg, 9caa, 9cap, (9cbz), 9cci, 9ccj, 9ceb, 9cgn, 9chd, 9cll, 9cjc, 9clq, (9cnd), (9ctf), (9ctr), 9cuc, 9cuh, 9cur, (9cvb), 9cyk, 9czl, 9dbh, 9del, 9dfg, 9dfq, 9dfv, 9dqu, 9dtk, 9dtt, (9dvi), (9dwx), (9dwxz), (9dxn), 9eak, 9eba, 9ech, (9efz), 9ehl, 9ehy, 9elb, (9ejl), (9ejy), 9eky, 9eld.

Canada: 1el, 2au, 2xa, 2bn, 2cg, 2fo, 3bl, (3kg), (3ly), 3wg, (3xi), (3zb).

England: 2od.

ICW: (c3ol), 8kx, 8rv, (8tj), (8tr), 8apt, (8ars), (8bhj), 8dat, 9aaw, (ncg), 1lt.

Spark: (1sl), 1azt, (8tj), (9gx-?) 9zw.

Phone: (ncg), 8ae, 8afu, 8bit.

Special CW: (je, nkt, nfv), (ncg).

Continued on page 46

FROM THE RADIO MANUFACTURERS

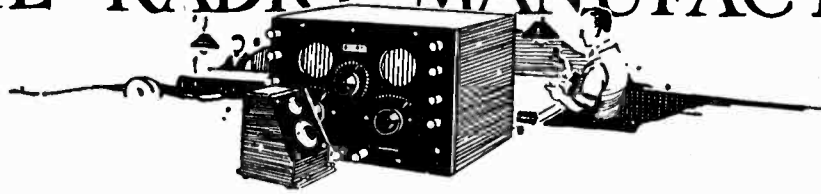

Supplementing the General Description of the Grebe Synchrophase Receiver, published in October RADIO, special interest attaches to the means whereby its extreme selectivity and stability of operation are attained. The tuned r. f. amplification is se-

The Mar-Co Air Di-electric Balancing Condenser is designed to neutralize tube capacity in radio frequency circuits or for other purposes when a small adjustable capacity is required. Settings are easily made and will remain permanent if de-

The Allen-Bradley Radiostat is a graphite disc compressor rheostat for use in the primary side of the supply transformer for transmitters of 500 watt capacity or less. It is intended to do away with the objection

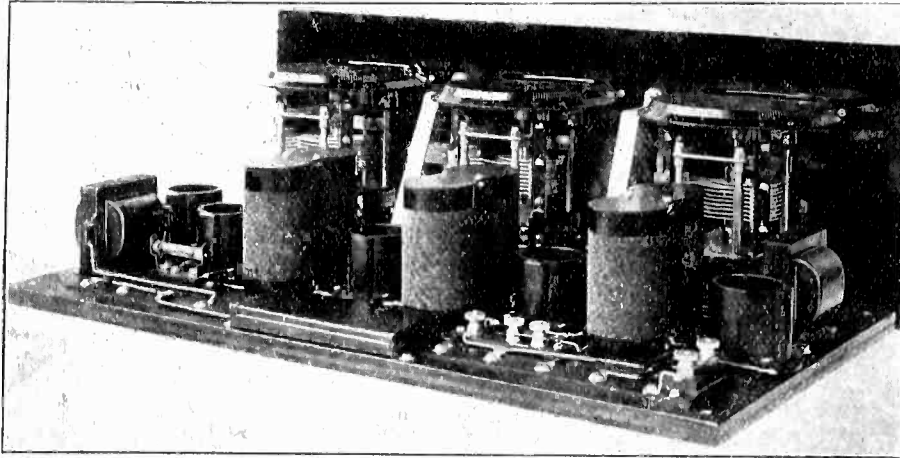

Radiostat—for Transmitters of 500 watts capacity and less.

caused by the displacement of the center tap when a rheostat is used in the transformer secondary. For transmitting sets of 10 watts or less the Bradleystat Type E-210 is recommended for this purpose.

The Paramount Loop is a spider-web wound with silk over phosphor-bronze wire and mounted on a bakelite frame. It is

cured with Binocular coils in combinations with S.-L.-F. (straight line frequency) condensers. Each of these new inductance units is composed of two solenoidal coils mounted closely together with their axes parallel and their two windings connected so that their electro magnetic fields are opposing and thus neutralizing one another. They may be mounted in almost any relative position and will not pick up external magnetic fields. Thus the set operates satisfactorily with a loop or close to a powerful radiocast station. The condenser plates are shaped in accordance with a formula involving hyperbolic spirals so as to give an equal spacing ($1\frac{1}{4}$ divisions of the dial) for each 10 kilowatts. Any change in dial setting is proportional to frequency rather than capacity and all settings are alike for any station. This avoids any crowding of the short wave stations on the lower portion of the dial. The set also has a new method of volume control, giving six gradual variations and permitting of the most desirable ratio of radio to audio amplification. All dials operate horizontally, projecting through escutcheons in the panel. Prof. Jansky has been asked to discuss the characteristics of the binocular evil in the next article in his series on radio frequency amplifiers.

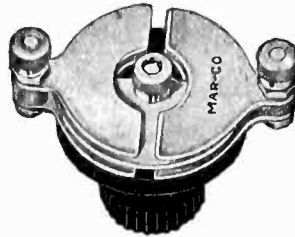

sired. It is arranged for panel mounting through one 5-16 in. hole.

The Sangamo radio ampere-hour meter gives an accurate visual indication of the true condition of a storage battery in emper-hours of discharge. It has a movable red pointer which may be set at the point where the battery should be recharged, which should be done when the indicating hand showing discharge approaches it. A

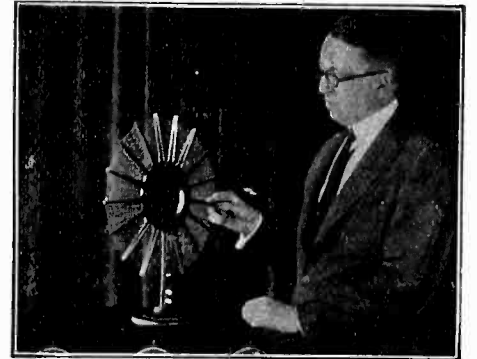

claimed to have extremely low dielectric losses and exceptional directional effect. It is 15 in. high.

The Erla "Circuit" Kit provides all necessary parts, together with a drilled and engraved panel, a complete set of blue-prints and directions for building a three-tube

The Caldwell Radio Socket employs a new method of gripping the prongs from the

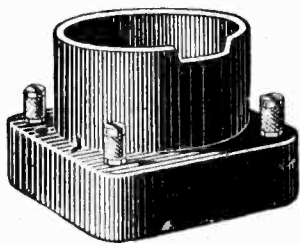

side in a hold-tight grip, eliminating any pushing up of the tube. The spring-clips are of phosphor bronze and the socket of molded bakelite.



contact is provided at the full point which may be connected to a light or bell to indicate when the battery is fully charged or to a small circuit breaker for automatically terminating the charge. It thus dispenses with the need for a hydrometer or voltmeter.



duo-reflex receiver. The parts include screws, nuts, wire and solderless connections so that pliers and screwdriver are the only tools required. A similar kit is made for a one-tube set.

Low losses and amplification *go hand in hand*

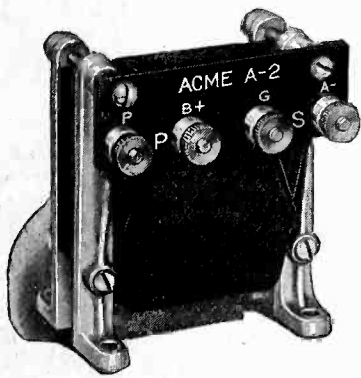

Acme A-2
Audio Frequency Transformer



Acme R-2, 3, 4
Radio Frequency Transformer

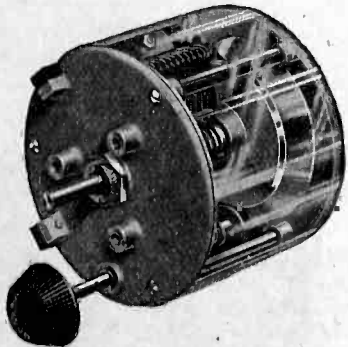

Acme .0005 M. F.
Low Loss Condenser

THE energy that your antenna or loop receives is at best only a little. Every bit of this energy you can save is the same as amplification. No matter what the circuit, you must have both low losses and amplification so that your loud-speaker can reproduce the distant stations loud and clear.

Acme Apparatus insures low losses, and amplification without distortion, for any circuit.

To get low losses, just replace your present condenser with a new Acme "lowest loss" condenser, and to get amplification without distortion, use Acme Transformers. Then you will get ten times the fun tuning in distant stations. You will get everything on a loud-speaker so that a whole roomful of people can hear and you will be able to enjoy all year 'round radio.

Send 10 cents for 36-page book, "Amplification without Distortion," containing many diagrams and helpful hints on how to get the most out of Radio.

ACME APPARATUS CO.

Dept. 85

Cambridge, Mass.

ACME *~for amplification*

Which would

This →

"WITHOUT ACCESSORIES"

Radio instrument	Loud speaker	Ground clamp
Antenna wire	Window lead in	Antenna spring
Connection wires	Mechanic's labor	Hammer
Clips	Storage battery	Nails
Lightning arrester	"B" batteries	Screws
Insulators	Tubes	Staples
	Your time	

Separate price for each of these items.

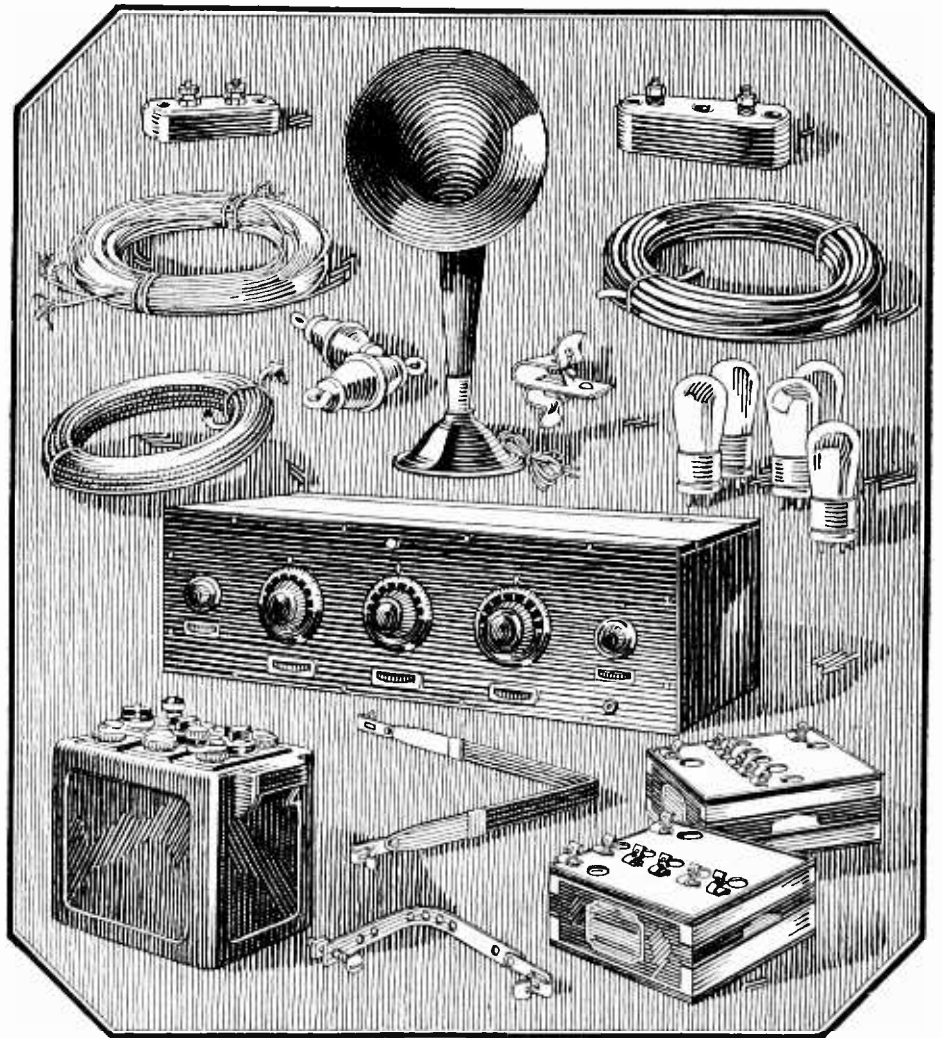

What "complete self-contained"

IT is the best of fun, we admit, to hook up a radio set, to string your antenna from tree to house, to connect your ground wire—at least it is fun if you are mechanically minded.

If, however, you want principally to *use* a radio set there are two things of primary importance—*first*, that its tone quality shall be absolutely pure, non-metallic and accurate; *secondly*, that it shall

be as little fuss and bother to you as is humanly possible. This means De Forest D-12 Radiophone—the leader in the field—bearing the imprint of Dr. Lee De Forest, the man whose great invention paved the way to radio broadcasting.

As to tone—it is impossible to describe the clean and natural tone quality which this instrument gives. You simply must hear it and judge

DE FOREST RADIOPHONE

REG. U.S. PAT. OFF.

REG. U.S. PAT. OFF.

you choose?

DE FOREST D-12 RADIOPHONE
 Complete in one unit, with everything necessary to use it
 immediately—all at the one initial cost.
 Prices according to cabinet finish and batteries.

		<i>With dry batteries</i>	
In Fabrikoid cabinet		\$161.20
In Mahogany cabinet		176.20
		<i>With storage batteries</i>	
In Fabrikoid cabinet		\$180.00
In Mahogany cabinet		195.00

← *or this*

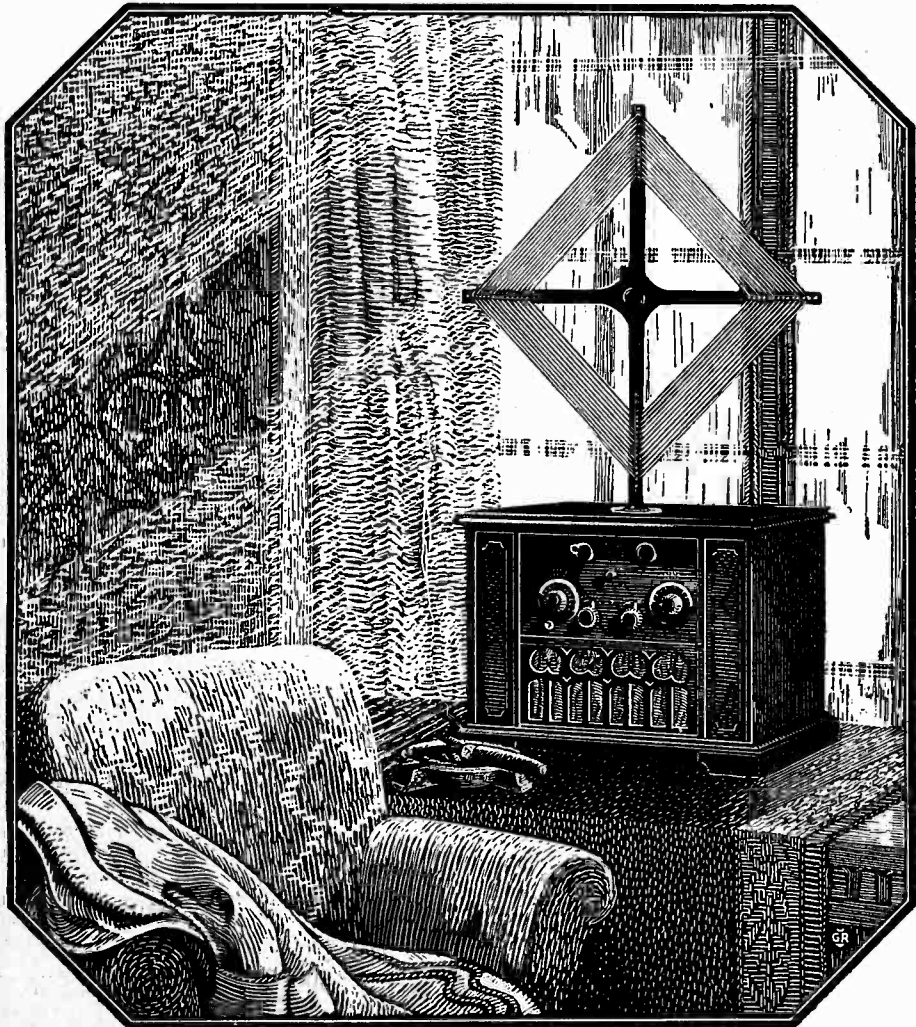

means as in De Forest

for yourself. And as for convenience, remember these important things: it is self-contained and complete in one unit—usable within five minutes after it enters your home—easily movable from room to room because it does not need to be attached to either antenna or ground.

When you find the De Forest agent in your

DE FOREST RADIO COMPANY, JERSEY CITY, N. J.

vicinity you find a man who knows radio—a man who has given us his word that he will see that every instrument he sells is thoroughly inspected and properly serviced after the sale.

Avail yourself of his help. He desires, as we do, that you should get the fullest enjoyment and satisfaction from your instrument.

Also makers of De Forest Tubes, The "Magic Lamp" of Radio

DE FOREST RADIOPHONE

REG. U.S. PAT. OFF.

REG. U.S. PAT. OFF.

Tell them that you saw it in RADIO

EISEMANN

ELECTRICAL EQUIPMENT

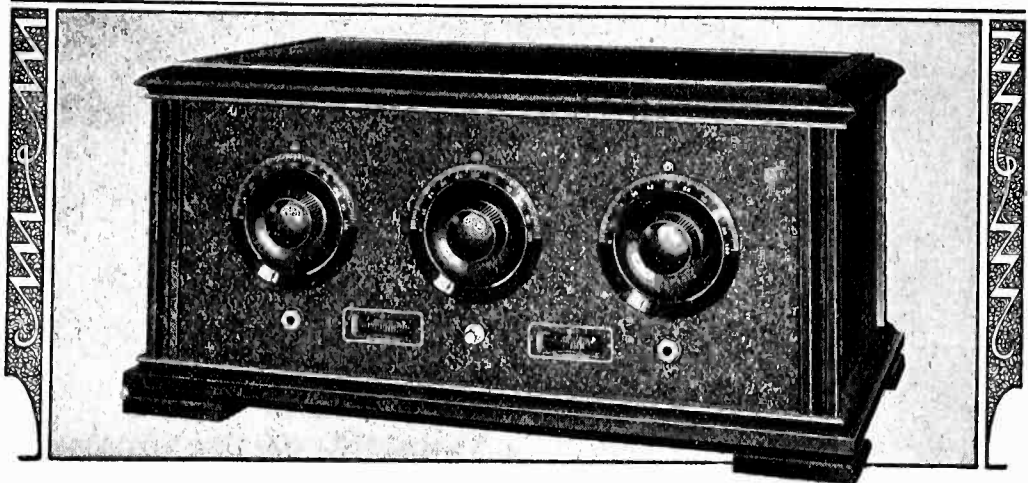

Choose Wisely

SPECIFICATIONS

Circuit: Two stages of tuned radio frequency amplification, detector and two stages of audio frequency amplification. Non-oscillating. Non-radiating. Astatic transformers used to minimize mutual induction.

Tubes: Five in all. Jacks provided for either five or four tube operation.

Batteries: Either storage or dry-cells.

Cables: Complete set supplied for "A" and "B" batteries.

Wave lengths: 100 to 600 meters, with uniform efficiency of reception.

Aerial: 75 to 125 feet, single wire.

Panel: Aluminum, with attractive crystal black finish. A perfect body capacity shield.

Dials: Sunken design. Shaped to fit the hand and permit a natural position in tuning.

Rheostats: Adequate resistance for all standard base commercial tubes.

Condensers: Single bearing, low leakage losses.

Sockets: Suspended on cushion springs which absorb vibrations.

Cabinet: Mahogany, with distinctive lines and high finish. Ample space provided for "B" batteries.

IN selecting a broadcast receiver, it is well to distinguish between essential and non-essential considerations.

The circuit is important, insofar as it affects performance, but the mysterious trick names now so much in vogue are not.

Type 6-D combines the only three things that constitute true value—efficient performance, attractive appearance and fair price.

Speech and music are reproduced without distortion. Far distant stations are received with generous volume. The selectivity is extraordinary—even powerful, local broadcasting stations tune sharply. The 6-D is non-oscillating and non-radiating, with unvarying reception efficiency at high and low frequencies.

In appearance, the 6-D is strikingly attractive—a handsome mahogany cabinet, symmetrical panel layout and perfectly proportioned interior construction.

Be sure to examine the Type 6-D Receiver before you make a final selection.

Price, Without Tubes and Batteries, \$125.00



For Sale by Reliable Dealers

EISEMANN · MAGNETO · CORPORATION

General Offices: 165 Broadway, New York

DETROIT · SAN FRANCISCO · CHICAGO

Continued from page 41

By GBLT, 6BNH, Ceres, Calif.

1abd, 4cy, 5ame, 5aro, 5bz, 5wl, 7abb, 7abf, (7acf), (7afb), 7ahs, 7akk, (7alk), (7ax), 7bj, 7de, 7df, 7fb, 7fd, 7fm, 7gr, 7gv, 7if, 7is, (7ku), 7mp, (7ng), 7nx, 7qc, 7qd, 7qn, 7sb, 7un, (7ur), 8ck, 8kc, 9aau, 9aol, 9blg, 9caa, 9cid, 9cfg, 9cfi, 9cro, 9bq, 9nv. Canadian: (5ba), 5gg. Mexican: bx. Fone: 7ahs, 7af.

By GALV, Alameda, Calif.

(1aac), 1bhm, 1boa, 1bsd, 1bvp, (1cmp), (1kc), (1pl), (1py), 1sf, 1gv, 1xz, (2aay), 2bgo, (2bqb), (2bqu), 2brb, 2cvj, (2cvu), 2czq, 2cz, 2ku, 2yg, (3wb), 2xg, 2xq, (3alx), 3adp, 3adq, 3apv, (3auv), 3bdo, 3bhv, 3bwj, 3cdg, 3chg, 3og, (3oq), 4auk?, (4cl), 4di, 4du, (4io), 4ku, 4oa, 4pi, 4pk, 4sb, 4sa, 4si, 4tj, 4xe, 5ac, 5ag, 5aec, 5aeq, 5aex, (5afu), 5afn, 5adh, 5agl, 5agn (5agq), 5ahd, (5aij), 5alu, (5ajh), 5ajj, 5ajt, 5aju, (5amg), 5amw, 5apg, 5aqs, (5ak), 5cn, 5cp, 5dw, 5ew, 5gu, (5hl), 5in, (5jf), 5ll, 5lu, 5lh, 5mi, (5mz), (5nw), 5oq, 5ot, 5ph, (5qy), 5se, (5uk), 5uw, 5vj, 5xa, 5za, 6als, 8ah, (8ada), 8aly, 8awj, (8bau), 8baa, 8ben, (8bpa), 8boq, 8cmi, 8cbp, (8cva), 8czy, 8cyl, (8dae), 8dal, 8dgp, 8dun, 8gz, 8jq, 8br, (8tt), (8pl), 8up, 8kk, 8ve, 8vq, 8vu, 8wo, 8bxh, "9's? too mani." Canadian: (2ax), (3aec), 3wu, 3wv, 4io, (4fv), 4cl, 5cn, 5as, 5ba, 5go. New Zealand: 4aa, 4ag, 4ak, 2ac. Australian: 3bq. All calls hrd on 1bgt tuner es I audio. Mostly on 75 to 86 meter band.

Calls Heard Below 100 Meters

By GBUK ex 3AKB, G. G. Maconomy.

4415 N. Griffin Los Angeles, Calif.

1bgc, 1cak, 1kc, 1ow, 1te, 2aay, 2ana, 2bpd, 2brb, 2pd, 3bhv, 3cdg, 3bg, 3bp, 3xi, 4tj, 4to, 4xe, 5acl, 5adh, 5agj, 5ajh, 5ame, 5ew, 5jf, 5ot, 5ov, 5ph, 5sd, 8bau, 8cwl, 8dsj, 8dl, 8sd, 8vt, 9aad, 9bjl, 9ccx, 9cee, 9cfi, 9cjs, 9ctr, 9ddp, 9ded, 9dqu, 9dxy, 9efy, 9eht, 9xbg, 9cjc, 9ap, 9bm, 9hw, 9xi, 9xw, 9za, 9zd. Mexican: 1b.

By Robert Amsbury, 6CLX, 317 N. Friends Ave., Whittier, Calif.

1abf, (1are), 1bie, 1kc, 1mo, 1pl, 1xz, 2aay, (2brb), 2cvu, 2dn, 2ud, 2xq, 3adg, 3ajd, 3aix, 3bdo, 3bof, 4jr, 4qf, 4rr, 4tj, 4tq, 4afn, 5agj, 5aij, 5alu, 5ajj, 5ame, 5dw, 5ek, 5jf, 5lu, 5ot, 5ox, 5rs, 5sd, 5se, 5uj, 5uk, 7acy, 7afo, 7ajy, 7akk, 7cw, 7fj, (7gb), (7gq), 7lj, 7jq, 7ku, 7ly, 7ot, 7qd, 7rk, 7ss, 7to, 7zg, 8ada, 8atp, (8bau), (8bxh), (8cyl), 8cko, 8gz, 8jq, 8jt, 8pl, 8xb, 9acl, (9axx), 9bcj, 9bxh, 9bjl, 9buk, 9cee, 9cii, 9cjc, 9cjs, 9cpm, 9ctr, 9ded, 9dkv, 9dyy, 9eel, (9efz), 9egh, (9eht), 9eky, (9elb), 9xbg, 9bm, 9ly, 9mn, 9nv, 9ny, 9xe, 9xi, 9zt, kaka, nkf. Canadian: 5an, 5on. If u hv hrd me don't be bashful with that qsl.

At 5KC, Plaquemine, La.

1dd, (1ez), 1sf, 1te, 1ah, 1xw, 1xav, (2fk), 2aay, (2aoy), 2bqb, 2cvj, 2cvu, (3cf), 3lg, 3agf, 3auv, 3bdo, 3buy, 3bva, (3cdn), 3xx, 3xav, 4al, 4bx, 4db, 4dt, 4dx, 4ik-phone, 4io, 4kk, 4pd, 4qf, 4sa, 4ua, 4ur, (5dp), (5hy), (5ka), (5nw), (5tb), (5uv), (5yd), (5alt), (5aom), (5apm), (5arl), (5asl), (5xbh), (6jp), 6vc, 6aa, 6alu, 6apw, 6bjj, 6bra, 6bur, 6cae, 6cek, 6cgo, 6ogw, (6crx), (6daa), 8eb, 8er, 8es, 8hv, 8tt, 8vq, 8yn, 8yx, 8abm, 8aey, (8afq), 8aig, 8ajn, (8alw), 8anm, 8apr, 8apt, 8apw, 8art, 8aua, (8bda), (8bdw), 8bma, 8boc, 8brc, (8byf), (8cbx), (8cjp), 8cko, 8cmi, 8cta, (8cvm), (8cyp), 8cwc, 8cxm, 8cyl, (8dal), (8dbm), 8dbo, 8dcr, 8dem, 8dgo, 8dnd, 8dnh, 8doo, 8dqk, (8dse), 9ca, (9ep), (9jh), 9ny, 9oa, 9tg, 9vc, 9zd, 9zt, 9aau, 9acl, (9adq), 9afu, 9agz, 9ahq, (9aim), 9akd, (9ala), 9aob, (9ape), (9arf), 9ark, 9asz, 9att, (9ayd), 9baz, 9beb, 9bga, (9bjp), 9bkj, (9bkz), 9boa, (9bpn), (9bxi), (9bzd), (9ccd), (9ckb), (9ctf), (9cyl), (9dyt), (9ejt), wvw, wgh. Canadian: 3ad, (3wv), (4cr), (4dq). Cuban: (2by). Mexican: 1b, 1f, 15, (9a).

By GHS, 1224 Milvia St., Berkeley, Calif. (70-80 meters)

1aza, 1bkq, 1cmp, 1sf, 1xav, 2ac, 2adp, 2ana, 2brb, 2gh, 2od, 3bta, 3cdg, 4qf, 4rr, 4uk, 5afn, 5ail, 5ajh, 5ajj, 5ajt, 5aju, 5ame, 5apg, 5ce, 5hl, 5mi, 5oq, 5ox, 5ph, 7afo, 7abb, 7ahl, 7ahs, 7ajy, 7aky, 7cw, 7gb, 7gk, 7gr, 7no, 7qd, 7rk, 7un, 8aey, 8buk, 8bwl, 8byn, 8dhw, 8gz, 8up, 8ve, 8zar, 8zy, 9aod, 9ap, 9bmk, 9bmx, 9cf, 9aau, 9cii, 9cjc, 9cjs, 9cju, 9cjl, 9cqv, 9cov, 9cyk, 9dhy, 9dqu, 9dvp, 9dyt, 9efh, 9egu, 9eht, 9ekf, 9mb, 9nv, 9qi, 9xi, 9xw (fone), 9zk, 9zt, 9cf, 9em. Canadian: 4cr, 4io, 5an, 5cn. NKF, NSE, NERK. Cards appreciated and answered promptly.

Continued on page 91

**"All that could ever be desired
in the way of satisfactory
radio reception"**

For Best Results, Be Sure You Get
The BALDWIN-PACIFIC

**45,000
CYCLE
SUPER-KIT
\$15.00**

**Thousands Now Know This
to be the Greatest Radio
Value Ever Offered**

Complete Super-Heterodyne Receiver May Be Built for \$45.00. A remarkable value, made possible through huge quantity production. *Build your own Super-Heterodyne, or have your dealer build it for you.* Rebuild or convert your old set to a modern and advanced type Super-Heterodyne. All other parts required are standard. Hook-up print with complete and simple instructions packed with each "Pacific Quintet" kit. Foresight and Advanced Engineering Efficiency now bring the latest and most popular developments within a price range to suit the average pocket-book.

*Approved by Leading Dealers, Jobbers
and Manufacturers Everywhere*



**Satisfaction
Guaranteed**
Finely
finished
merchandise
built for
real work.

"Pacific Quintet" Super-Het Kit
Consisting of 1 Pacific "Ranger" No. 30 Oscillator Coupler, 3 Pacific "Ranger" No. 25 Intermediate Frequency Transformers and 1 Pacific No. 20 "Ranger" Filter Transformer.

Minneapolis
208 Boston Bldg.

Indianapolis
336 Burgess Av.

Detroit
4417 Vancouver

St. Louis
1724 Olive St.

Cleveland
205 Zeller Bldg.

New York
220 Broadway

Philadelphia
Bourse Bldg.

Los Angeles
432 M. Harris
Bldg.

Denver
311 Kittredge
Bldg.

Chicago
53 W. Jackson
Blvd.

New Orleans
Whitney Central
Building

The Baldwin-Pacific Co.
Pacific Building.
San Francisco, California.

Gentlemen:-

In reply to your query of recent date as to the performance of my "Pacific-Quintet" equipt SUPER-HETERODYNE set, you are advised as follows.

The set is very easily tuned, and extremely quiet in operation, despite the fact that it is located in a room where even the furniture is of metal, and on board a ship where all the machinery is electric driven.

As to its selectivity! I find no difficulty whatever in tuning out CKCK on 420 meters, and bringing in KPO on 423 meters. Or in tuning out KFHR on 283 meters, and tuning in KPSG on 278. This without any interference whatever, and without employing the directive qualities of the loop.

The following stations were received on loud speaker with this set during the past week, Sept 14 to 22.

KFHR	KPO	KFAE
KGO	KFKX	KFSG
KTW	KFOA	CFDC
KFPT	KMO	CNRC
KGB	KDKA	CNRW
WFAA	CFAC	CFQC
KGW	KHQ	KFBL
WOAW	KFI	CKCD
KLX	KHJ	CKCK.

While not an authority on radio sets in general, or the SUPER-HETERODYNE in particular, it is my belief that this circuit, employing your "Pacific-Quintet" kit in its construction, will bring to the reasonable individual, all that could ever be desired in the way of satisfactory radio reception.

Very truly yours,

Lieut. C.H. Forth, U.S. Navy.

The above letter is an example of many received certifying to the superior efficiency and marvelous performance of the "Pacific Quintet" Super-Kit.

Baldwin-Pacific & Company
Pacific Building **San Francisco**

Los Angeles
432 M. Harris
Bldg.

Denver
311 Kittredge
Bldg.

Chicago
53 W. Jackson
Blvd.

New Orleans
Whitney Central
Building

Minneapolis
208 Boston Bldg.

Indianapolis
336 Burgess Av.

Detroit
4417 Vancouver

St. Louis
1724 Olive St.

Cleveland
205 Zeller Bldg.

New York
220 Broadway

Philadelphia
Bourse Bldg.

Super-Ducon

A Major Radio Invention

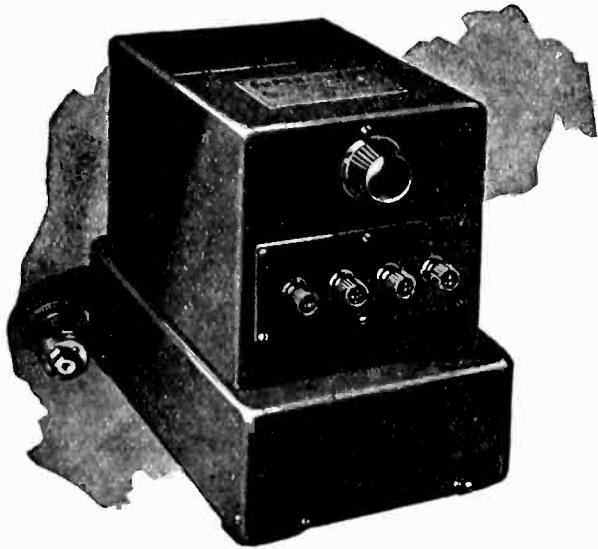

A. C. Type

\$47.50

D. C. Type

\$30.00

No more "B" batteries!

The Super-Ducon is the most important and valuable radio invention of the year. It brings many advantages to the set owners. Upkeep expenses are cut. No more of the expense and fuss of installing "B" batteries. No more poor reception due to weak batteries, but 100% performance all the time!

Ask your dealer for a copy of the
16-page Super-Ducon Booklet

Dubilier

CONDENSER AND RADIO CORPORATION

**Fits Grid Leak
any mounting**

**FRESHMAN PLUNGER
TYPE VARIABLE GRID LEAK**
was designed especially for the non-technical set owner who can replace in an instant the fixed grid leak with this new, efficient cartridge type Variable Grid Leak; without requiring the change of a single wire.

At your dealer
or by mail post-
paid. Write for
free catalogue.

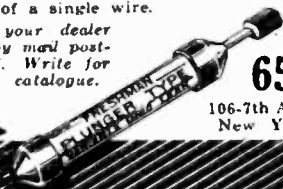

65c

106-7th Ave.
New York

FREE CATALOG FREE

**NEW COCKADAY
4 CIRCUIT TUNER**

**WITH RESISTANCE
COUPLED AMPLIFIER**

It will be well worth your while to use the identical parts specified by Mr. Cockaday without changes or substitution of any kind. Complete parts, including drilled panel and set of three full-sized blue prints.

COMPLETE KIT, \$54.75

WHOLESALE RADIO SERVICE CO.
Dept. R., -9 Church Street, N. Y. C.

THE JONAH OF JASMINE BJONES

Continued from page 23

he had become a man, though still a shy and sensitive one. At last he stood in the radio room which was to be his home while the noisy steamer *Merced* clanked her way from San-Fran to Seattle to San Pedro and back again, with lurches suggestive of a torpedoed ore-scow. Jasmine sighed as he regarded the out-of-date spark set before him, and the worse receiving panel which covered several square yards of area, or hard-rubber, he could not be sure, and housed nothing more formidable than a lot of unnecessary coils of wire and a fairly decent piece of galena. He sighed again, and then smiled as he thought of the neutrodyne in his trunk. Smiling, he addressed the bedraggled-looking parrot whose cage he had placed on the operating table, and who had been his inseparable companion for the past two years.

Jasmine Bjones had bought Sweaty, at the present moment doing a very clever imitation of an eighty-year-old water-soaked feather duster, from a man who claimed to be a down-and-out radio operator. The man had told him how Sweaty had once saved hundreds of lives by shrieking "SOS" time after time into the mouthpiece of a ship's powerful radiophone, after she had been deserted by all hands, including the radio operator. Such a brave bird, he had told Jasmine, would be invaluable if a man ever intended to go to sea. How Sweaty had managed to escape from the sinking ship he forgot to relate, but Jasmine never thought of that till a long time afterward. Now he turned and spoke to the bird gently, for he loved the fiendish creature as a man can love only his best friend—his *only* friend.

"Sweaty, old pal, life isn't going to be so bad after all, is it? Even if this ship is only a lumber boat not bound for joyous far corners of the earth. A radio operator at last—Gee, I was afraid it'd never come true, and I've always wanted it so badly— Why, Sweaty, you lovely old reprobate, I believe you're seasick already, and the *Merced* not yet out of sight of the Golden Gate. Shame on you!"

"Arr-rr-rk," said Sweaty. "Yoh, it's terrible, terrible,—terrible!" A phrase that he had learned from the San Francisco newsboys.

Jasmine fully agreed with him later when he, too, suffered from the same affliction. Between-times of losing his meals over the side and wishing he were dead he worked in the stuffy radio cabin getting what was alleged to be a radio set in working order. Every time he pressed the key of the high-power spark transmitter he either had to hunt for a new sensitive spot or find a new crystal. "This will never do," he told Sweaty. "Pretty soon there will be no more

Continued on page 50

Subscribe to "RADIO"—\$1.00 brings it for 6 Months

Modulation plus Regeneration



MODULATION PLUS REGENERATION IN NEW MODEL L-2 ULTRADYNE

20 DX Stations logged on August 25th on Loud Speaker using loop aerial at Covington. Ky

Modulation plus regeneration is the keynote of the new Model L-2 Ultradyne Receiver. Regeneration as applied to this new method of radio reception produces greater rectification than ordinary methods of detection—a vital step in radio engineering. This combination produces tremendous amplification when receiving weak signals. Allows the Ultradyne to respond to a very small amount of energy. Signals are amplified thousands of times before they are detected and made audible.

Mr. R. H. Thomas, 509 Coppin Building, Covington, Ky., writes: "The Ultradyne far surpasses any idea that I previously had as to what a radio receiver could be. On the night of August 25th, 1924, I tuned in on my Ultradyne, the following stations:

- WBZ Springfield, Mass.
- WOR Newark, N. J.
- WGY Schenectady, N. Y.
- WHN New York, N. Y.
- WCAP Washington, D. C.
- WEAF New York, N. Y.
- WOO Philadelphia, Pa.
- KDKA Pittsburgh, Pa.
- WCBD Zion, Ill.
- WJAR Providence, R. I.
- WGR Buffalo, N. Y.
- WTAS Elgin, Ill.
- WAAM Newark, N. J.
- WABM Saginaw, Mich.
- WNAC Boston, Mass.
- WEAN Providence, R. I.
- WLW Cincinnati, O.
- KSD St. Louis, Mo.
- WWJ Detroit, Mich.
- WHO Des Moines, Ia.
- WTAM Cleveland, O.
- WHAZ Troy, N. Y.
- WOS Jefferson City, Mo.

- WSB Atlanta, Ga.
- WMC Memphis, Tenn.
- WOC Davenport, Ia.
- WBAP Ft. Worth, Tex.
- WNYC New York, N. Y.
- WOAW Omaha, Nebr.
- WFAA Dallas, Tex.
- WSAI Cincinnati, O.
- KFKX Hastings, Nebr.
- WCK St. Louis, Mo.
- WBT Charlotte, N. C.
- KFKB Milford, Kan.
- WGAQ Shreveport, La.
- KGO Oakland, Calif.
- KFJM Grand Forks, N. D.
- KFI Los Angeles, Calif.
- WDAF Kansas City, Mo.

"I consider the above reception remarkable as it stands, but considering it was all accomplished on a 24-inch loop, and all but WGAQ, KFJM and KFI, were heard on the loud speaker, it far surpasses anything that I have heretofore experienced.

"As regards selectivity, will say that I am only four or five miles from the powerful WLW station at Cincinnati, operating on 423 meters, and his wave is so powerful that I can receive him on the loud speaker, with one stage of audio, loud enough to be heard a block away, without using antenna, ground or loop. When WLW is on the air, I can tune him out completely, and receive WSB on 429 meters, WHB and WDAF on 411 meters, and PWX, nominally on 400 meters, but usually somewhat above that wave.

"I know of no other receiver that will even approach this performance for extreme selectivity, volume and distance."

ULTRADYNE

MODEL L-2

This application of regeneration is the most recent development of R. E. Lacault, E.E., A.M.I.R.E., since his perfection of the "Modulation System" used exclusively in the Ultradyne and which has so revolutionized all conception of selectivity, sensitivity, volume and range.

This Model L-2 Ultradyne, without a doubt, represents the peak of present day super-radio engineering skill.

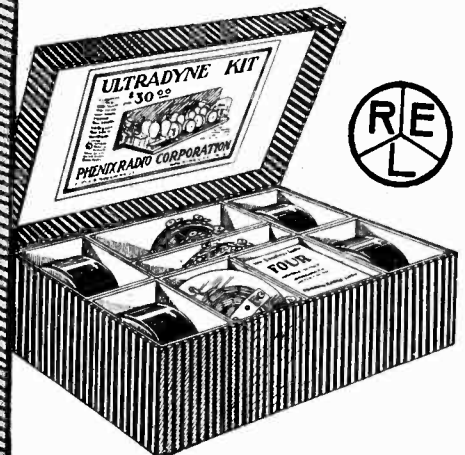

Ultradyne Kit

Consists of one low loss Tuning Coil, one low loss Oscillator Coil, one special low loss Coupler, one type "A" Ultraformer, three type "B" Ultraformers, four matched fixed Condensers. The Ultraformers are new improved long wave radio frequency transformers, especially designed by R. E. Lacault, Consulting Engineer of this Company and inventor of the Ultradyne.

To protect the public, Mr. Lacault's personal monogram seal (R.E.L.) is placed on all genuine Ultraformers. Ultraformers are guaranteed so long as this seal remains unbroken.

\$30.00

Send for 32 page illustrated book giving latest authentic information on drilling, wiring, assembling and tuning the Model L-2 Ultradyne Receiver.

50c



Write for Descriptive Literature

PHENIX RADIO CORPORATION

9 Beekman Street,

New York City

AMERICAN BRAND CONDENSER

\$5⁰⁰
IN CANADA \$7.00

100 to 1

With the
Worm Drive Vernier

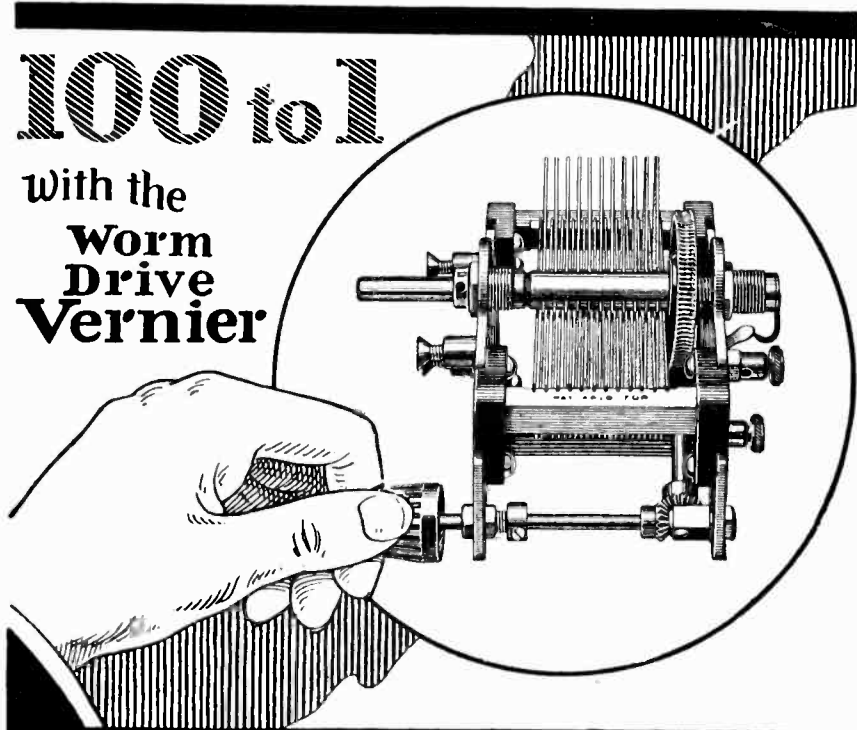

One of the biggest contributing factors to the growing popularity of Radio reception is this fine tuning condenser.

Made with a geared vernier having a ratio of 100 to 1, American Brand Condensers assure the successful operation of any set, especially when there is more than one broadcasting station in the air. For DX reception, American Brand Condensers can't be surpassed.

American Brand Condensers need only to be seen to prove their superior qualities. Ask your dealer to show it to you and to give you a descriptive folder.

Wholesale Distributors everywhere throughout the country are prepared to fill dealer's orders.

Note to Dealers: If your jobber is out of stock, please write us.

AMERICAN BRAND CORPORATION
 8 West Park Street NEWARK, N. J.

Send \$1.00 for a trial subscription to 'RADIO' for 6 months, starting with the Feb. issue.

"B" BATTERIES

AN
EVEREADY
 PRODUCT
 At Standard Prices

43V. Batteries, tapped
 22½V. Batteries, Navy Type
 22½V. Batteries, Commercial Type
 Latter two types especially adapted to
 Cunningham and Radlotron Tubes.
 Postage Prepaid Anywhere in U. S.

ETS-HOKIN & GALVIN
 Wireless Engineers
 10 Mission Street San Francisco

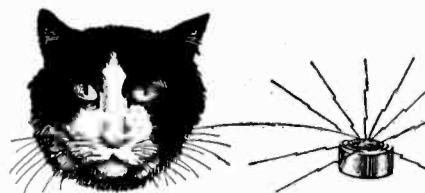

An I. X. L. KAT WHISKER
 on your crystal set will bring in greater distance, clearer reception and louder signals. Solid gold, will not corrode or oxidize. Ideal for reflex. **PRICE 25 CENTS**

U. C. Battery & Electric Co.
 2158 University Ave., Berkeley, Cal.

Continued from page 48

crystals, and there are no radio supply stores in the middle of the ocean."

"It's terrible," agreed the parrot, now hopping about gayly, the sea-sickness having been successfully conquered. Jasmine allowed him the freedom of the radio room, and he had already formed a habit of escaping from there to the bridge, and thence laboriously to the very top of the mainmast, where he would preen himself in the sun while his frantic master looked everywhere for him.

Finally Jasmine gave the huge crystal panel up in despair—he was used to giving things up by now, though the first touch of sea-sickness was gone but not forgotten—and hooked up the neutrodyne. Then indeed was he in heaven. This was what he had dreamed of for years—the thrill of listening to signals which he knew were coming to him over miles of clean, wind-swept ocean. Little ships, big ships; little sets, big sets; high whistling tones like flutes, low roaring notes like fog-horns—electricity winging its way through the clean air to the wires which hung high above his head, and then down into the ears of himself, the radio operator of the good ship *Merced!* He could hardly believe that it was all true. Heaven! And then his heaven came tumbling down about his head.

The crew of the *Merced* were pleasure-loving men. In fact, they might be called hilarious. If there was anything they enjoyed it was a practical joke; the cruder the better. Many were the decayed fish that they had placed in each other's bunks; many were the packets of chewing tobacco and ashes and worse that they had dropped into the soup of Wo Sin, the Chinese cook. They had concentrated their efforts upon the soup because it was Wo Sin's particular pride. They enjoyed his frantic rage, his tearful pleadings to desist, his Oriental profanity, and when finally he was wise enough to feign indifference they let him alone, and abandoned their soup-spoiling for more amusing efforts. That had been on the previous voyage.

Now there was a new man on the ship, and the chuckling villains strove desperately to find some weak point in his armor upon which they might concentrate, as they had upon Wo Sin's beloved soup. The men already resented the coolness with which "Sparks" treated them, keeping entirely aloof, never cracking a smile. Thus they were doubly joyful when they at last stumbled upon, or pounced upon, the weak point for which they had been seeking—Sweaty. Someone had discovered that the new radio operator could not bear to have the bird out of his sight, that he loved him as most men loved a woman, another man, or a dog.

Continued on page 52

ZENITH RADIO

TRADE MARK REG.

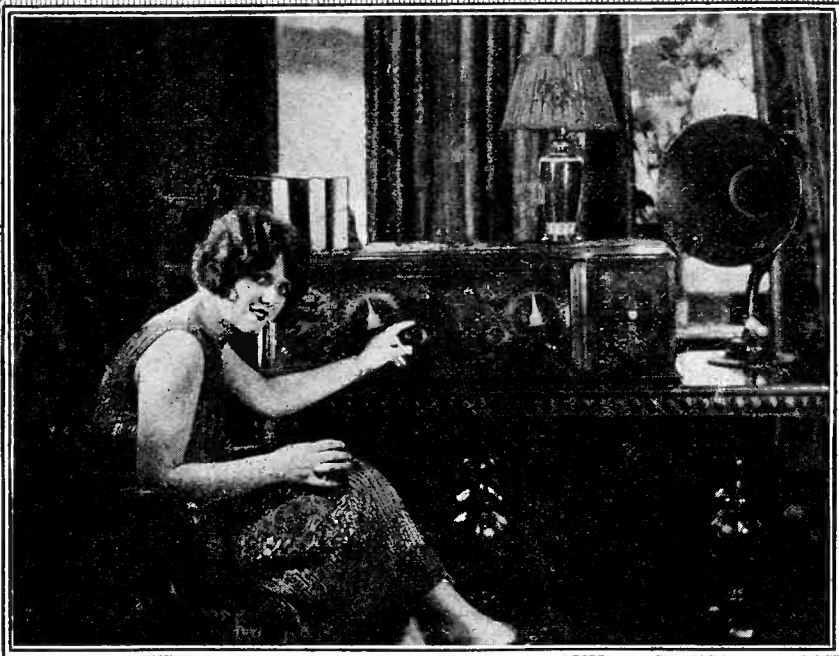

Super-Zenith VII—
the ideal radio set
for the fine home

They Cost More
But They Do More

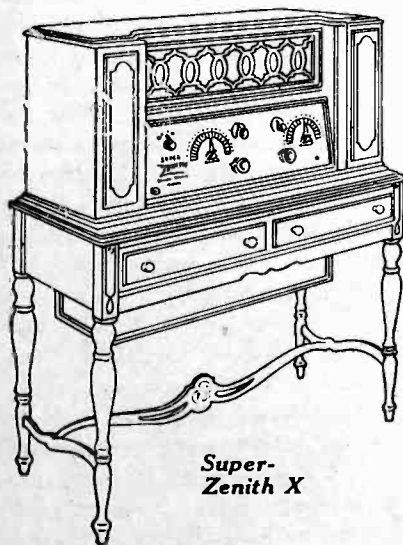

Super-Zenith X

Each station comes in at the same point on the dial, *always*

You don't need to be a "radio engineer," and you don't need to have three hands, to operate the new Super-Zenith. Tuning is controlled by *two dials only*—so perfectly adjusted that each station comes in always at the same dial settings. *It never varies.* Powerful locals may be on full blast, yet, if you like, you can tune them out completely, choose the distant station.

Those who know and appreciate truthful tone reproduction find in the new Super-Zenith an unfailing source of delight. Their pleasure is all the greater from the fact that even when silent the Super-Zenith lends to its surroundings charm and distinction.

Write to us for the name of the nearest dealer from whom you can obtain a demonstration of this outstanding marvel of the radio world.

Dealers and Jobbers: Write or wire for our exclusive territorial franchise

ZENITH RADIO CORPORATION

Executive Offices: 332 South Michigan Ave., Chicago

ZENITH—the exclusive choice of MacMillan for his North Pole Expedition
—Holder of the Berengaria Record

THE complete Zenith line includes seven models, ranging in price from \$95 to \$550.

With either Zenith 3R or Zenith 4R, satisfactory reception over distances of 2,000 to 3,000 miles is readily accomplished, using *any ordinary loud speaker.* Models 3R and 4R licensed under Armstrong U.S. Pat. No. 1,113,149.

The new Super-Zenith is a six-tube set with a new, unique, and really different patented circuit, controlled exclusively by the Zenith Radio Corporation. **It is NOT regenerative.**

SUPER-ZENITH VII—Six tubes—2 stages tuned frequency amplification—detector and 3 stages audio frequency amplification. Installed in a beautifully finished cabinet of solid mahogany—44½ inches long, 16¾ inches wide, 10½ inches high. Compartments at either end for dry batteries. Price (exclusive of tubes and batteries) **\$230**

SUPER-ZENITH VIII—Same as VII except—console type. Price (exclusive of tubes and batteries) **\$250**

SUPER-ZENITH IX—Console model with additional compartments containing built-in Zenith loud speaker and generous storage battery space. Price (exclusive of tubes and batteries) **\$350**

SUPER-ZENITH X—Contains two new features superseding all receivers. 1st—Built in, patented, Super-Zenith Duo-Loud Speakers (harmonically synchronized twin speakers and horns), designed to reproduce both high and low pitch tones otherwise

impossible with single-unit speakers. 2nd—Zenith Battery Eliminator, distinctly a Zenith achievement. Requires no A or B batteries. Price (exclusive of tubes) **\$550**
Price (without battery eliminator) **\$450**
All Prices F. O. B. Factory.

Zenith Radio Corporation
Dept. 1H
332 South Michigan Avenue, Chicago, Ill.

Gentlemen: Please send me illustrated literature giving full details of the Super-Zenith.

Name

Address

CELORON
BAKELITE RADIO PANEL

Size 7 x 12

MANUFACTURED BY
DIAMOND STATE FIBRE COMPANY
BRIDGEPORT (Near Philadelphia) PENNSYLVANIA U. S. A.
MAKERS OF
CELORON - Diamond-Fibre - VulcaWood

Offices in Principal Cities
IN CANADA, DIAMOND STATE FIBRE COMPANY, OF CANADA, LTD., TORONTO, CAN.
Incorporated in U. S. A.

How to Work and Finish Celoron Bakelite Panels

DRAW full size layout of the holes to be drilled on a sheet of heavy paper, cut to exact size of panel. Transfer centers of holes through the paper to the Celoron panel with a pointed instrument.

The drilling can be done with a carpenter's brace or a hand drill, but metal-cutting twist drills should be used, not ordinary wood bits. Begin to drill from the front side of the panel. To avoid chipping on back, clamp panel to a board or work bench. Counter-sink holes with a larger size drill. Holes can be threaded with standard machine taps.

If a dull or mar finish is desired rub down the panel with No. 00 sandpaper. The sandpaper should be wrapped around a wooden block and the rubbing all done in one direction, not with a circular motion.

Wipe off the panel with an oil cloth.

Continued from page 50

Jasmine had learned where the miserable bird spent its afternoons, so he worried no more about it, knowing that Sweaty would come home to the radio room and his cage when the sun went down. He did not know what to make of it, therefore, when in response to his whistling no Sweaty came fluttering down from the maze of rigging overhead to perch upon his shoulder. He whistled frantically and ran about the deck asking if anybody had seen the bird, even climbed the main-mast, but no Sweaty rewarded his search. The crew leaned weakly against each other, shaking with suppressed mirth and imitated his whistling skilfully, so that if poor Sweaty had been up in the rigging he would have gone insane trying to flutter to so many masters at once. But Sweaty was not there. Alas!

Sweaty was in the fo-castle, where blonde Lars Larsen was decorating him according to the Larsen idea of art, and singing meanwhile, "For you're to be Queen of The May, Sweaty," in a high falsetto, while the tears rolled down his ruddy cheeks.

Jasmine spent a sleepless night, but he felt worse the next morning when he saw Sweaty. The bird came marching bravely into the radio room, lifting his feet like a cavalry horse and talking happily to itself, but when it saw the look on its master's face it dropped its head and whimpered pitifully. Sweaty reeked of paint. His legs were gray, striped, his body black with a white shirt-front. Wings were in the futurist style, and his long red, white, and blue tail stood out in startling contrast to his yellow and purple head, on which rested a tiny hat. About his body were leather bands from which rose two slender masts bearing a diminutive radio antenna and the neatly lettered placard:

.
WHY DON'T SPARKS WRING MY
DIRTY NECK?
BECAUSE HE HAS THE PATIENCE OF
JASMINE ONUS BJONES
.

As popular as radio itself

AS more and more radio novices become seasoned fans, the popularity of Celoron Panels multiplies.

Today Celoron is the accepted standard for radio panels. Sets of many foremost makes are equipped with Celoron bakelite panels and parts.

Celoron does not chip or crack. It does not soften, warp or buckle. It is infusible and will stand up under atmospheric changes.

Look for Celoron Panels where you buy your radio supplies. Insist on Celoron insulation in the parts you buy.

Celoron is also made into tubing which has all of the insulating qualities of sheet Celoron. It is used extensively by manufacturers of the best radio instruments. It is made in all sizes and diameters.



This Celoron rack on a merchant's counter means that he wants to give you the best in radio parts. Look for it.

DIAMOND STATE FIBRE COMPANY

Bridgeport, Pa. and Chicago, Ill.

The oldest and largest manufacturer of vulcanized hard fibre and laminated bakelite materials in the world.

Wherever chimneys smoke and wheels turn there are countless electrical and mechanical uses for Celoron and Diamond Fibre.

The Romance of the Sea!

Read the Story of the Life of a Sea-going Radio Operator

\$1.00
Per Copy

"THE RADIOBUSTER"
SENT POSTPAID ANYWHERE
PACIFIC RADIO PUB. CO.
Pacific Bldg., San Francisco, Cal.

\$1.00
Per Copy

Jasmine gathered the dejected bird to his breast, thereby ruining a good uniform coat, and rushed to Wo Sin with a request for gasoline. "No gas on bo'd. Velly sollee!" said Wo Sin. Lars Larsen had told him that if he didn't use exactly those words there would be two very large cuds of used chewing tobacco in the Captain's soup the next morning. When Sweaty persisted in shrieking, It's terrible, terrible, terrible," all the way back to the radio cabin, and continued while Jasmine was attempting to clean him with soap and water, the crew sim-

Continued on page 54

"THE ACE OF INDEPENDENTS"

Types
201 A - 199



Yankee Tubes

\$4.00
GUARANTEED

**COST
NO MORE
THAN
ORDINARY
TUBES**

Yankee Tubes—rugged as the hills of New England—are built to last—and to perform. Peak satisfaction in detection and amplification—perfect workmanship. Immediate delivery.

**AT
YOUR
DEALER**

Yankee Tubes are immediately available for filling your order. Guaranteed to produce the best results—warranted as to workmanship and design. Thousands testify to their superior performance. They cost no more.

TRADE MARK REGISTERED

U. S. PAT. OFFICE 1924

Sold only thru
well-established
retail dealers

DEALERS—Write to the
distributor in your terri-
tory as shown below for
attractive proposition

Distributed by

W. E. & W. H. JACKSON, San Francisco
MARSHALL-WELLS, Portland
THE BANTA CO., Los Angeles

BALDWIN-PACIFIC & CO., San Francisco
(Pacific Coast Representatives)

HEATH RADIANT

Non-Dielectric Condensers



Marconiphone

Used by

MARCONI

IN designing a receiver to bear the magic name of "Marconi" only the most dependable instruments were safe even to consider. The eventual selection—after exhaustive research and tests—of HEATH CONDENSERS for this famous receiver, tells a convincing story of lasting dependability—the hidden extra value that you get with every Heath Condenser.

Prices for Vernier Condensers

No.	Capacity	Plates	With Dial	Without Dial
No. 11AV	12	Plate	\$5.00	\$4.35
No. 24AV	24	Plate	5.50	4.85
No. 44AV	44	Plate	6.50	5.85

Non-Vernier types in all capacities.

Heath Sockets with the Exclusive Shock Absorber Feature. Price 75c.

Heath Genuine Bakelite Dials in 3 diameters.

See the Heath Condenser at your dealer's.

Write for Literature

HEATH
Electric
208 First
Street



RADIO & Mfg. Co.
Newark,
N. J.

Canadian Distributors:
Marconi Wireless Telegraph Co. of Canada, Ltd.
Pacific Radio Distributors:
FREDERIC L. TOMLINSON CO.
1113 Wall St., Los Angeles, Cal.
443 Pacific Bldg., San Francisco, Cal.
1512 Boylston Ave., Seattle, Wash.

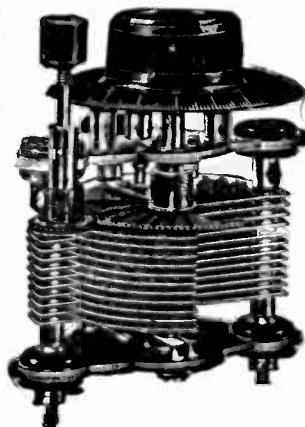

Permanently Flat Plates

Stamped under huge presses to absolute flatness and tempered to prevent warping.

Micrometer Geared Vernier

Ordinary adjustments reduced by separate geared adjustment to hairbreadth distinction. We guarantee the Heath Vernier Condenser to be more highly selective than any condenser employing a vernier which actuates ALL of the plates.

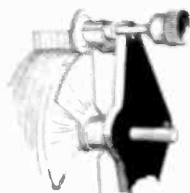

Continued from page 52

ply lay on its collective back and wept hysterically until the captain saw them and ordered all but the watch below.

This was but the beginning. The hazing continued for the rest of the voyage and began again at the start of the next one, which was to be merely a repetition of the first. Jasmine had decided at San Francisco that he would stick it out, though the temptation to quit his job was great. He dreaded going back to the ship; dreaded to face all those other men once more, that were always laughing at him. The morning of the second day out he found a painted banner across the door. "Who's the bum radio op?" it asked. And answered itself by proclaiming, "BJASMINE BJONES, BJJ BJOSH!"

Like Wo Sin, Jasmine feigned indifference as best he could, but it seemed to make no difference. For the most part the men, though they were unmerciful, were also good-natured about what they were doing. Only one of them, a big fellow named Boles, seemed to be deliberately spiteful; long after the others would have stopped, Boles egged them on, and as he was the bully of the crew and had been known to half-kill a man with one blow of his hairy fist, his wishes were obeyed.

The radio operator learned that the man Boles was the ringleader from Wo Sin, who had become his friend probably because he himself had been forced to endure what Jasmine was getting. Reinforced by what Wo Sin had told him, Jasmine attempted to make friends of one or two of the men, smiling when he happened to meet them about the ship, even venturing a timid, "hello, there." Jasmine had heard the phrase "inferiority complex" used once at a lecture, but he never imagined that it might apply to him. He knew only that he was half-afraid of the men about him, and he tried hard to fight off the feeling and treat them as he knew they expected to be treated, and make them his friends.

Some of them grinned sheepishly when he spoke to them; one returned the greeting, kindly enough. The crew was on the new radio operator's side, had he but known it. They were simply waiting for him to retaliate in some way—to "blow up," to play a joke on them in return, to swear at them, to hit one of their number on the jaw; anything to demonstrate his manhood. The more he was humiliated, however, the further Jasmine tended to creep into concealment. He rarely left his radio cabin, except for meals, which he had with the captain and the first and only mate. When not busy "pounding brass" he read over his meagre stock of books, tinkered with the set, and talked to Sweaty, which was unsatisfactory due to Sweaty's limited vocabulary. So things went until one eventful Saturday evening.

Continued on page 56

The Lopez Low Loss Tuner

—endorsed by K. E. Bradley, Technical Editor of Wireless Age—
As being the best low loss tuner for maximum selectivity and great reception range. In congested metropolitan areas the results obtained with the LOPEZ LOW LOSS TUNER far surpass any other make. It is also superior in sensitivity on distant stations.

All coils are set back sufficient distance from panel to prevent any possible hand capacity effects and dielectric losses in panel. Regeneration at all wave lengths, tunes easily and it's secondary can be calibrated.

Broadcast type 200 to 600 meters.
Regular Amateur 40 to 205 meters.

Circuit diagrams, panel drilling templates and instructions with each tuner.

At your dealer's or sent direct postpaid

A. C. LOPEZ & CO.

344 Fifth Avenue, New York City

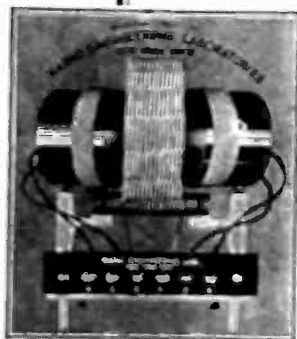

Price
\$10.00
each

REMEMBER The FEBRUARY ISSUE of "RADIO" will be a knockout

Tell them that you saw it in RADIO

The Question of B Battery Current Has Been Solved with the Trans "B" former

The *Kellogg* Trans-B-former furnishes the necessary plate voltages for your radio set, from your 110AC, 60 cycle, electric light socket without any interferences.

This unvarying current is furnished at less than one-fifth cent per hour. Throw away your "B" batteries and install a Trans-B-former and your set will operate at maximum efficiency constantly.

The *Kellogg* Trans-B-former will:

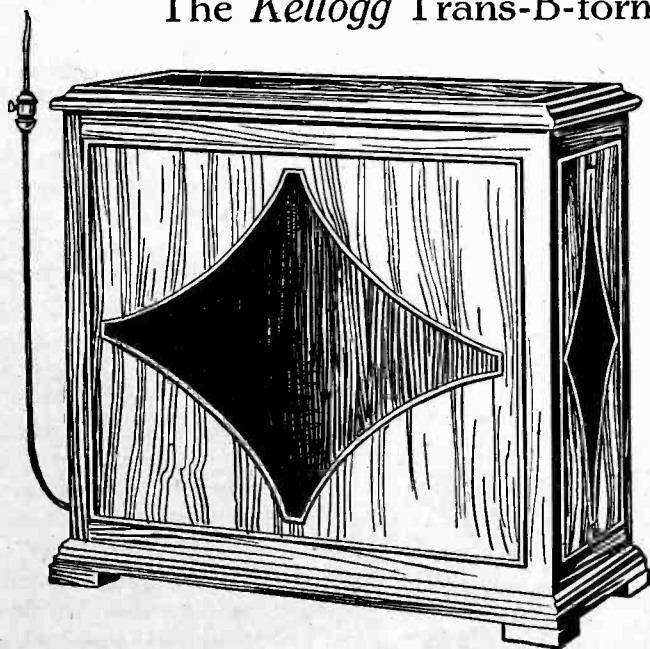

- Improve reception.
- Reduce operating cost to a minimum.
- Add to the appearance of your set.
- Increase DX possibilities.
- Developed, perfected and guaranteed by the Kellogg Switchboard and Supply Company.

At Your Dealers

Each.....\$50.00

KELLOGG SWITCHBOARD & SUPPLY CO.

1066 WEST ADAMS STREET, CHICAGO

The MOZART Baby GRAND Radio Reproducer



You Gave the Best

No piece of radio apparatus even in its price class is the best because its maker says so or because its dealer says so. It is only the best when everybody else says so as well.

"To say I was surprised is putting it mildly. It is the best I have ever had and I have had the _____ and others. Am going to recommend the M-G. I like to help a company that is on the square and gives everybody their money's worth."

(Signed) A. S. Kay, Charleston, West Virginia.

PRICES (WEST OF THE ROCKIES)

Baby Grand Reproducer, with gold plated unit, black and gold crackle or extra heavy coated all black satin finish (approx. 12" bell)	12.50
Electro-magnetic unit (fits almost any horn or phonograph) with cord—	
Nickel plated	1.50
Gold plated	5.50
Mozart Special Headset	6.00

If your dealer cannot supply, order direct.

West Coast Representatives:

NELSON-RUDE CO., 16 California St., San Francisco, Cal.
JAEGAR RADIO CO., 4505 36th Ave., N.E., Seattle, Wash.

THE MOZART GRAND CO.

Manufacturers of Fine Instruments

Newark, N. J.

U. S. A.

In the afternoon Jasmine, locked in his cabin, had heard two men approach and stop just outside his door. The door was fairly thick, but he could not help but hear their raised voices, which was exactly what they desired. He heard the roaring voice of the man Boles ask someone else, "I wonder if little Jazz, Mine Ownus"—he had fallen into the habit lately of referring to Jasmine thus—"I wonder if B'jonas is in his cabin. If he is I ought not talk like I'm going to talk, suh. It might hurt his feelings."

"I don't rightly know, captain," replied the other man, snickering.

"Wall, it's unimportant, suh," had said the one whom Jasmine was sure was Boles, exaggerating the slight Southern drawl of the captain. "I just wanted to tell you-all a few things about him, suh."

"Yes, captain." Another snicker.

"You know, suh, the men hev been a-ridin' him a little bit. Just in fun, you know, suh. And that white-livered jellyfish ain't had the nerve to talk back to even the littlest shrimp in the bunch!"

"You don't mean to tell me, captain! Now ain't that too bad!"

"Yessuh! Why, that green operatuh has a stripe of yelluh up his back as long as Wo Sin's pigtail, suh—"

The dialogue had continued for the better part of an hour, while the man on the other side of the door heard every word, and came very close to tears. Cold beads of perspiration stood out on his face, which was as white as death, and his nails dug into his palms until they bled.

That had been in the afternoon. Now it was evening and the *Merced* was beating her way southward through heavy seas, her aged heavily-laden hulk groaning as if each plunge was to be her last. A heavy sea was running.

Jasmine got a position report from two compass stations ashore and, hanging his 'phones on the hook, took it immediately to the bridge. A heavy fog was closing in on the *Merced*; the skipper looked worried. "Hm-m-m," he frowned, when Jasmine handed him the blank. "I had no idea we were so close in-shore, Sparks. According to this we're uncomfortably near Point Conception, where those seven Navy destroyers went aground. Get hold of the compass station again and ask for verification. It doesn't seem possible that this one could be correct. Damn this fog, anyway!"

"Yes, sir." Jasmine left the bridge and made his way down the bridge ladder to the deck, shivering as the dank coldness of the mist made itself felt through the thin stuff of his uniform. The door to the radio room was ajar. He entered, slamming it to after him, and sat down before the operating table preparatory to calling KPH. Quickly

Continued on page 58

RADIO

BIG MONEY IN A BIG FIELD

Be a RADIO EXPERT. Make big money. Win success in this new uncrowded field. Trained men needed. Learn quickly, at home in spare time, to construct, install, operate, repair, maintain and sell radio equipment. **\$3,000 TO \$10,000 a Year!**

RADIO EXPERTS EARN

Short course, low cost, easy terms, money back guarantee.

FREE Wonderful tube receiving set of latest design. Range of over 1000 miles. Write today for "RADIO FACTS."

A. G. Mahaupt, Radio Eng. Radio Association of America
4513 Ravenswood Ave., Dept. 81 Chicago

3 TUBE LOUD SPEAKING



only
\$29.50

FULLY GUARANTEED

LONG DISTANCE RADIO

Users everywhere report Miraco Tuned Radio Frequency sets get programs coast to coast! Outperform sets 3 times as costly. Send for proof they are radio's most amazing values. One tube guaranteed, completely assembled long distance outfit, only \$14.35. Three tube (above), \$29.50. Five tube \$75

SEND POSTAL TODAY for latest bulletins and special offer. It will interest you.

MIDWEST RADIO CORP'N
Pioneer Builders of Sets
8 E. 8th St., Cincinnati, Ohio

AGENTS DEALERS
Our proposition's a winner. Write.

MIRACO RADIO GETS 'EM COAST TO COAST

If you want to INSURE RECEIPT of "RADIO" regularly, send \$1.00 today for a special 6 months' trial subscription

TYPES
630-631

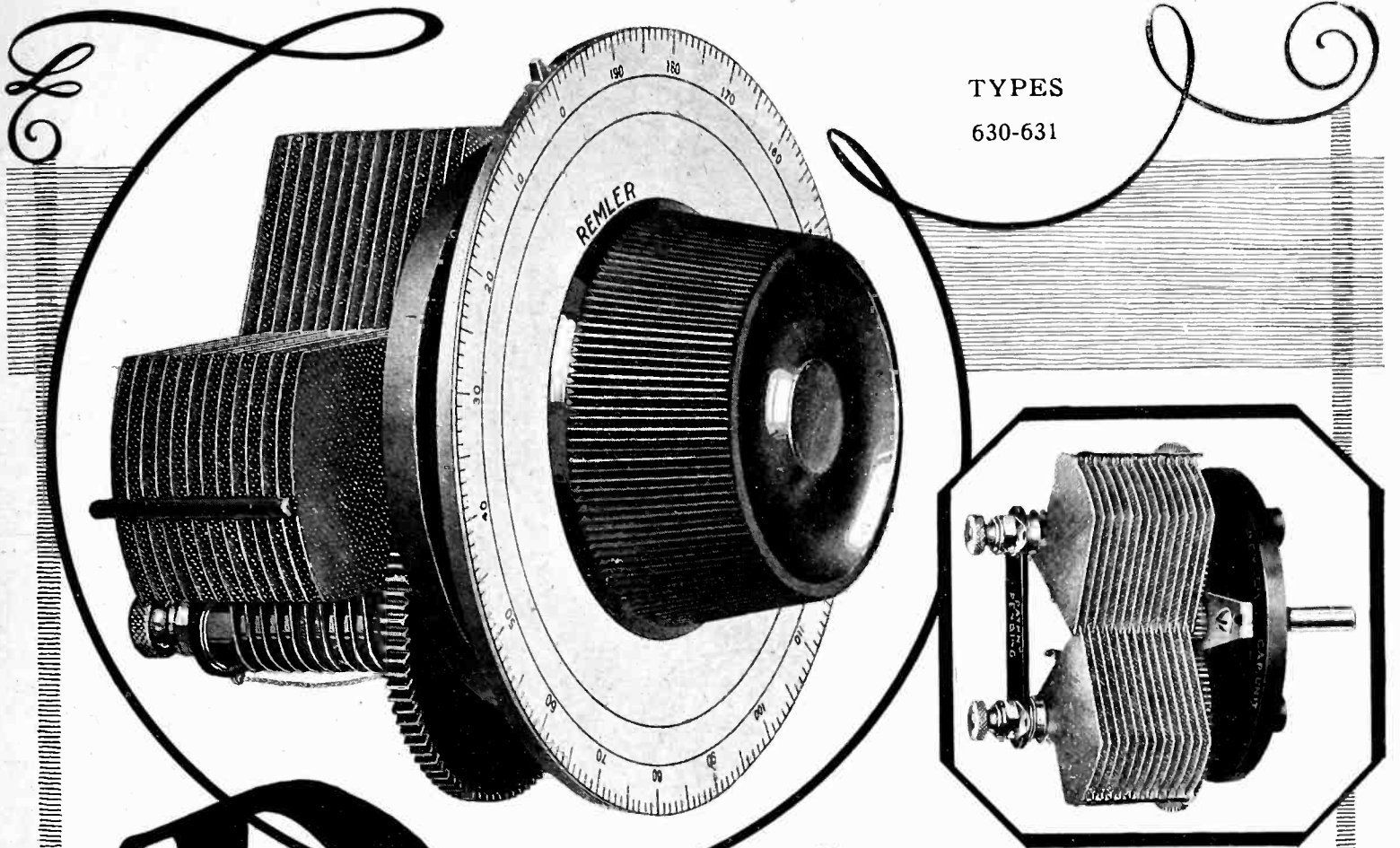

Remler Variable Capacity Unit

Only Actual Use Will Demonstrate Its Outstanding Value

THE illustrations tell the story.
360° dial rotation permits closer tuning—accuracy to a degree hitherto unattained.
Ample bearing surfaces give exceptional smoothness of operation.
Logging is simplified by the renewable dials.
Maximum to Minimum Capacity Ratio is 165:1, the highest ever attained.
Especially adapted to low wavelength tuning, because of its low minimum capacity—.000003 mfd.—and its very gradual capacity increase over lower dial settings.

Bakelite gears driving insulated rotors eliminate body capacity effects.

And the cost—quoted below—includes the 360° logging dial.

No. 630—Remler Capacity Unit, Minimum .000003, Maximum .00035, Complete with Dial.....

EACH

No. 631—Remler Capacity Unit, Minimum .000003, Maximum .0005, Complete with Dial.....

\$5.00

Dial Stop and Indicator are included, also drilling template.

REMLER RADIO MANUFACTURING COMPANY

Home Office: 182 Second St., San Francisco

Chicago

New York

Continued from page 56

he threw the switches on the control panel and pressed the key, but the rotary gap seemed to behave queerly, and the needle on the radiation ammeter remained at zero. He made a hurried examination of the transmitter, but could find nothing wrong.

Tears of vexation sprang to his eyes. Just his luck! Fog, important orders from the skipper, and a dead radio set. Jasmine sprang to his feet, leaving things as they were with the motor still running, and ran out upon the deck. Glancing upward through the fog he fancied that he saw a dark figure descending the mainmast-shrouds. In a flash the thought struck him: Could those fools have dared to cut his antenna lead? His breath came faster, and red specks danced before his eyes. He hurried to where he had seen the figure, and started aloft, clinging with all his might to the tarry ratlines as the ship careened from side to side. The higher he climbed the greater became the arc through which the mast was swinging. He felt dizzy. At last he reached the top, where the shrouds met the mast, and, clinging with his knees, reached out and felt along the cold, dripping cable to which the suspension insulator of the flat-top antenna was fastened. On the other side of the heavy insulator his clawing fingers found a fine copper wire which seemed to come up from nowhere and fasten to the antenna itself. He jerked it loose, and for a minute, while the mast swung wildly and he was able only by sheer strength to keep from being hurled eighty feet downward into the boiling sea, he held the thin strand of copper in his left hand while with his right he gripped one of the aerial wires. In that instant he heard the crescendo whine of the rotary gap in the radiq cabin far below, and thirty thousand volts of high frequency electricity went through his body. His hands, where they touched the wires, were seared as if a white-hot iron had been dragged across them. The shock loosened his hold, and it was only by a superhuman effort that he was able to fling his arms about the rigging before the mast reversed the direction of its swing and flung him out into space. Physically sick, he crept down the ratlines a step at a time, gained the deck and leaned weakly against the door of the radio room. Recovering himself to some extent he stepped inside—and faced the evilly grinning countenance of Boles.

He could not find his voice. "Y-you g-grounded my—the antenna—you tried to kill me," he shuddered, horrified, loathing in his voice, "Y-u—dirty—rotten—"

"I fastened that wire to the ones up on the mast to have some fun," laughed Boles. "When you discovered what the trouble was I had a chance to give you a shock, by pressing this thing on the

Continued on page 60



DUAL RATIO

GROUNDING ROTOR

LOW-LOSS CONDENSER
PLAIN & VERNIER TYPE

PRECISION MOVEMENT, ABSENCE OF GEARS OR COMPLICATED PARTS

UNITED SCIENTIFIC LABORATORIES, INC.

Improved Type **RHEOSTATS** and **POTENTIOMETERS**
All Sizes

GENUINE BAKELITE SUPERIOR CONSTRUCTION



United Scientific Laboratories, Inc.
92-94 E. 10TH ST. NEW YORK CITY

The Aristocrat Radio Desk

Designed by the Signal Radio Engineers to meet all the requirements of the radio fans. A beautiful Radio Desk that is an attractive addition to any home. Mahogany finish with a built-in loud speaker (Unit Extra) and compartments for "A" and "B" batteries, battery charger, etc. The Aristocrat is spacious enough to accommodate Super-Heterodynes, Neutrodyne and other large sets. 42" high, 36" wide, 16" deep, \$55.

Write us for illustrated folder.

SIGNAL Tube Socket

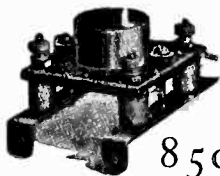

85c

Metal tube with Formica base. Heavy phosphor bronze spring, extra brackets for panel mounting. Rubber bushing for base mounting. Nothing better made.

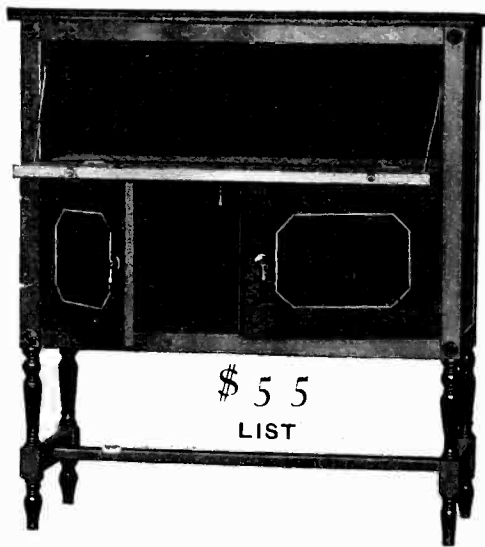

\$ 5 5
LIST

SIGNAL Electric Mfg. Co.

Factory and General Offices
1913 BROADWAY
MENOMINEE, MICH.

Boston Chicago Seattle Minneapolis Montreal
New York Philadelphia Pittsburgh Havana, Cuba
St. Louis San Francisco Toronto Winnipeg Los Angeles

You'll find our local address in the Telephone Directory

Write today for your free copy of

Ward's New Radio Catalogue

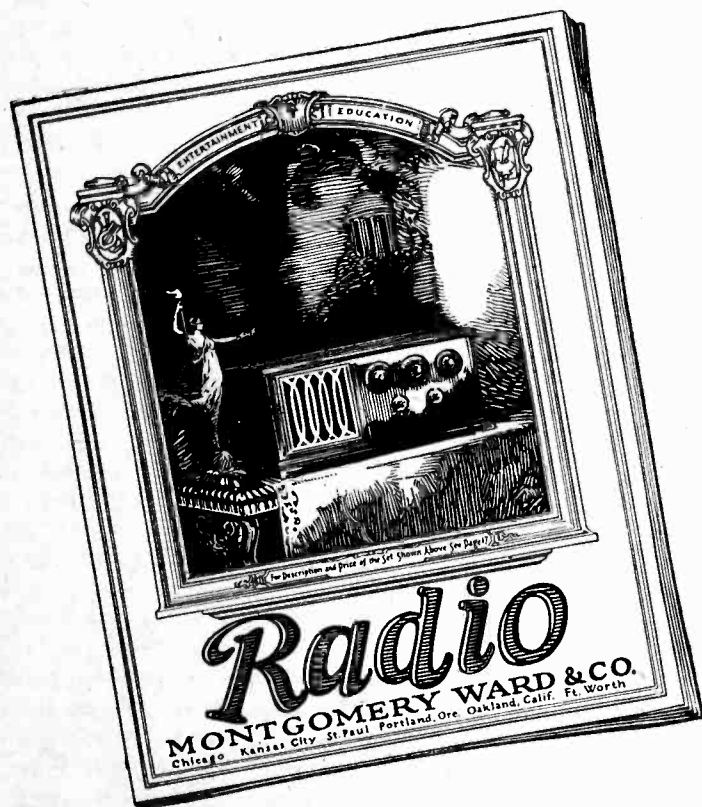

WARD'S Radio Catalogue is a big 68-page book—a real reference volume on quality Radio Equipment. In addition to descriptions of sets, parts and hook-ups, much matter of general interest to every radio fan is included. The book will prove fascinating to the confirmed radio enthusiast as well as to the beginner.

Tested and guaranteed
Radio equipment sold without the usual Radio profits

WARD'S Radio Department is headed by experts who know and test everything new. Who know by experience what is best—what gives the best service.

Our catalogue is prepared under their supervision. It shows all the best hook-ups, everything in parts and complete sets—so simple that you yourself can install them in a short time.

Headquarters for Radio

Today Ward's is serving thousands upon thousands of Radio fans who have written for our catalogue, who have been surprised to see how low in price the standard Radio equipment can be sold without the usual "Radio Profits."

You, too, can profit by writing for a free copy of Ward's Radio Catalogue. If interested at all in Radio, you should write for this book. See for yourself the savings.

Our 53-Year-Old Policy

For 53 years we have sold quality merchandise. We never sacrifice quality to make a low price. In buying Radio Equipment at Ward's, you are buying from a house of proven dependability. Address our house nearest you: Dept. 39R

ESTABLISHED 1872
Montgomery Ward & Co.

The Oldest Mail Order House is Today the Most Progressive

Chicago

Kansas City

St. Paul

Portland, Ore.

Oakland, Calif.

Ft. Worth

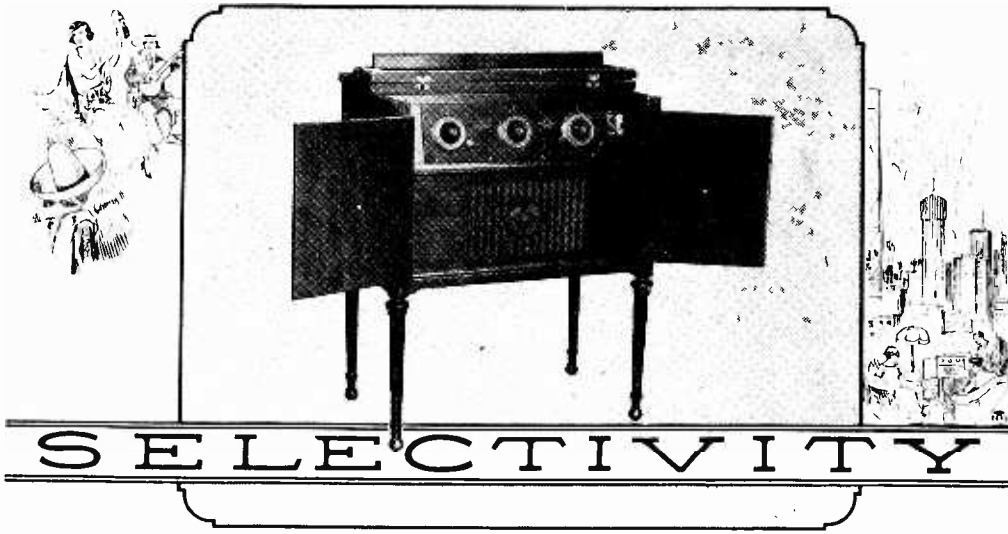

SELECTIVITY

WITH a Radiodyne you can choose from any of the programs on the air. Nearby broadcasting cannot prevent you from getting distant stations. The Radiodyne will bring in the program you select clear and distinct no matter where broadcasted or where you live.

If you can get it with any set you can get it better with the

Some RADIODYNE

Type WC-12

Features

- Has an Amazing Degree of Selectivity
- Uses Dry Cell Tubes
- Receives from Great Distances
- Has Wonderful Volume
- Exceptional Clarity
- Self Enclosed in Beautiful Two-Tone Mahogany Cabinet
- All Models Are Comparatively Low Priced

Write for Our Free Booklet

Western Coil and Electrical Co.
311 Fifth Street
Racine, Wisconsin

RADIODYNE

60 Ft. "HERCULES" Aerial Mast

\$45 Freight Prepaid

20 Ft. \$10
40 Ft. \$25

All steel construction. Each Mast complete with guy wires and mast head pulley. Write for literature and Free Blueprint.

S. W. HULL & CO., Dept. G2
2048 E. 79th St., Cleveland, Ohio

BROWNLIE CRYSTAL

\$1.00

"REFLEX SPECIAL" QUICK CONTACT RECTIFIER GUARANTEED

The Acme Apparatus Co. says "prevent distortion and howling by using a BROWNLIE CRYSTAL in Reflex Sets"

Order From Your Dealer or Direct.
ROLAND BROWNLIE & CO.
24 Saunders Street, Medford, Mass.

table, here. I hadn't planned that part before; I had to time it pretty exactly."

"But—man—the shock might not kill me—high frequency juice—but I'm not used to keeping my hold aloft—new man—no sailor. *You knew that!*"

"You're plenty green, alright," sneered Boles.

"But—my God! It's a penitentiary offense to tamper with a ship's set, you fool! And especially in a fog, when the radio is needed for getting bearings—"

For a moment Boles' face paled. Then he recovered his composure. "Well, what are you going to do about it?" he asked, swelling his chest and folding his massive arms upon it. "Report me to the old man, I suppose? Get me fired, so I won't bother you any more? Be just like you, B'jonas!"

"No," said Jasmine. I won't give you what you know you deserve. No, I'm not going to do that. I'm going to—"

His words were drowned in a crash of ripping keelplates and splintering timbers. The *Merced* shuddered throughout her length, and listed slightly to port. There was a hideous scraping sound as the teeth of the reef tore into her vitals. Point Conception! Doom of many vessels. The masts were coming down. A manilla cable-end, heavy as any iron bar after its fall of eighty feet, struck Jasmine a glancing blow on the shoulder and brought the blood as he ran outside. Boles had preceded him, shoving the lighter man aside in his hurry to escape, gibbering like a drowning rat.

Deadly Point Conception! An error made somewhere, by someone. The crew were all on deck, hardly able to see the mate or the captain, who barked orders from the bridge to abandon ship, a long gash slowly staining his snowy hair. "Our only chance—run line ashore—rig breeches buoy—" His words came faintly through the wind. "Who—can—swim—m—m?"

No one answered. Two of them were sniveling.

The captain raged. "Sailors!" he cried. "Sailors! Deep water men; blue-water men! And not one—" he choked—"not a mother's son can swim. Scum—m—m!"

Jasmine quietly stepped forward and walked to the bridge. He shed his clothes as he went. "I'll try it, sir. I—I'm a fair swimmer. Used to sneak off by myself when I was a kid—my only fun. Later—Y. M. C. A.—'Frisco."

"Get this man a line—a light one," the captain roared. He turned to the naked man before him and spoke more gently, as befits gentlemen. "If you don't make it, lad," he said, "I'll never forgive myself. Swim southward—let the wind and current carry you 'way

Unsurpassed selectivity, sensitivity, range, volume and tone combined

Looks like—and performs like—a \$200 radio set

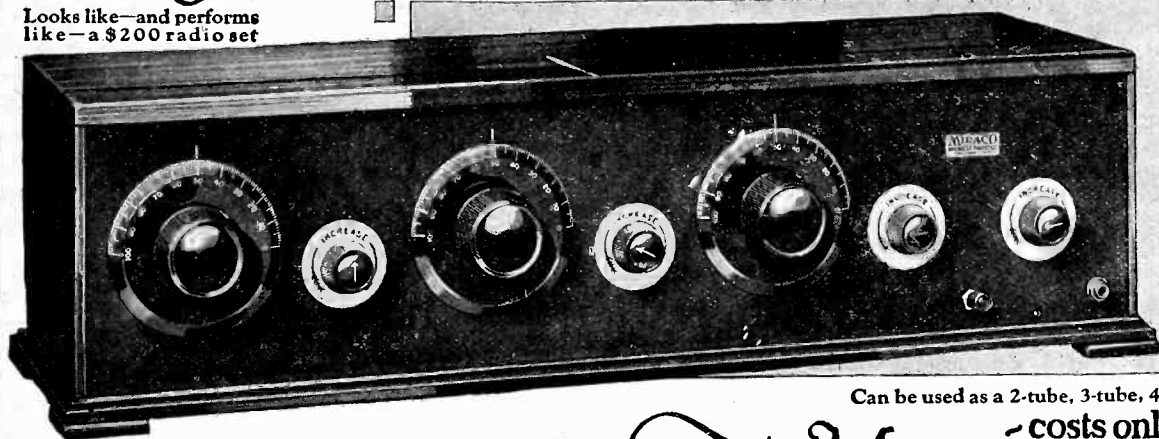

BUILT TO GIVE LOUD SPEAKER ENTERTAINMENT FROM STATIONS THOUSANDS OF MILES DISTANT WHILE LOCAL STATIONS ARE BROADCASTING

Can be used as a 2-tube, 3-tube, 4-tube or 5-tube set.

"Coast to Coast" reception

verified by Miraco Users

NOTE! Do not judge Miraco sets by their prices. Enormous production makes them cost less. They are built—by pioneer set makers—of highest grade parts. They embody improvements, refinement and features used in the most costly sets. Every Miraco user is an enthusiastic booster—these letters are typical of the many we receive.

Miraco "Shows" Missouri

I bought one of your radios last summer and like it fine. Have picked up stations from Coast to Coast and from Canada to Cuba. My motto with the Miraco is: "What's the use to pay more when the Miraco will reach as far as you can understand the language!" —George V. Scott, Moberly, Mo.

Wisconsin Gets 'Em All Over U. S.

Am well pleased with my Miraco. Have listened to stations from the extreme eastern and western parts of the United States and as far south as Beaumont, Texas. It has come up to my expectations in every way. —J. H. Halbert, Augusta, Wis.

New York Hears England And Brazil

Am very glad I bought a Miraco as it works the best of any I have heard. All the people who come to listen say that when they buy a set it will be a Miraco. Have heard London, England and Rio de Janeiro, Brazil, with my Miraco. It sure works fine. It is the best set on the market for the price. —Leo Link, Marcy, N. Y.

Pennsylvania Hears California

The Miraco is a real "Coast to Coast" set. Last night I tuned in on KGO, Oakland, Cal., WFAA, Dallas, Texas, KFKX, Hastings, Neb., besides 15 other stations. Have received 55 in all. It is a wonderful set for the price. —Earl C. Way, Coleman, Pa.

Iowa Hears N. Y. to Cal.

Have heard from New York to California on my Miraco. All who have heard it think it fine. —Chauncey Bailey, Stockport, Iowa.

Beats Some \$300 Sets

The Miraco that I bought last Fall is giving better satisfaction than some \$300 sets others have here. —Otis Morris, Warren, Idaho.

Indiana Gets Coast To Coast

Have received stations as far away as Oakland, Cal. and New York. I can get any station and am very pleased with my Miraco. —Eddie Smith, Meliott, Ind.

Nebraska Hears Cuba

Miraco sure is a go-getter. I get better reception than anyone in this neighborhood. Had WSAI, Cincinnati, on loud speaker in July—pretty good for warm weather. I tuned in KGO, Oakland, Cal. and WBZ, Springfield, Mass., and have heard PWX, Havana, Cuba, a number of times. —Vernie J. Gustason, Blair, Neb.

"Hears The Scotch"

I'm proud of my Miraco. Have had it since Canada, Glasgow, Scotland—of which any one should be proud—with nearly every station in the U. S. —Farley A. Neet, Catlin, Ind.

The Marvelous MIRACO Ultra 5

costs only \$75

[FIVE TUBE OUTFIT IN BEAUTIFUL SOLID MAHOGANY CASE]

Completely built, thoroughly tested and factory guaranteed by one of America's oldest and most reliable manufacturers of quality sets! Years of experience and quantity production explain its almost incredible price. Users, who have deluged us with commendations, say that friends who see and hear it are amazed that it sells for less than \$150 or \$200. Radio experts, who know good construction and quality parts, are equally astonished. You, too, will be delighted, thrilled, amazed with your big five-tube Miraco "Ultra 5" in its beautiful hand-rubbed solid mahogany cabinet! You'll be envied by radio friends who paid big prices for their outfits. Imagine getting all this for \$75—a beautiful sweet

toned "coast to coast loud speaker" set, composed of finest parts, housed in solid mahogany, equipped with the latest improvements, refinements and features found on costliest sets—and factory guaranteed! An instrument approved by radio's highest authorities! A set anyone can connect and operate. Even beginners learn quickly to cut through the "locals," get distant stations loud and clear, log stations and return to them at will. (Full directions with each set.) It is non-radiating, non-distorting, non-howling. Has cut-out switch—and a first stage phone jack for tuning—on Bakelite panel. All wiring concealed under Bakelite sub-base. Works on storage battery or dry cells. Literature describes other newest features.

Send Coupon for Special Offer!

Other Miraco Long Distance Sets \$14.35 up



Users tell us that Miraco Model R justly deserves its title, "Radio's finest low priced quality receiver." One tube acts as a tuned radio frequency amplifier and detector combined. A great distance getter. Easy to operate and log. Covers all wave lengths 150 to 625 meters. Like all Miraco sets, it operates on a storage battery or dry cells. Never such value before at only \$14.35

MIRACO RADIO GETS 'EM COAST TO COAST

This wonderful new Miraco Model R-3 is the three-tube, long distance, loud speaker set that has created such a sensation. Easy to tune and log. Covers wave lengths 150 to 625 meters. Detector acts also as a tuned radio frequency amplifier. 2 stages audio frequency amplification. Has no equal for simplicity, volume, range or clearness at anywhere near its price



Miraco R-3 only \$29.50

The famous Miraco Model MW four tube "coast to coast loud speaker" outfit which users all over the country report outperforms and outdistances much costlier sets. Comes in a solid mahogany cabinet. The improved 1925 model is equipped with cut-out switch, first stage phone jack for tuning (removing plug automatically switches program to loud speaker) and other latest features. Employs one stage of radio frequency amplification, detector and two stages of audio frequency amplification. Another unmatched Miraco value, \$54.50.

These Miraco sets are as easy as a phonograph to operate. Built throughout of highest grade parts. Full directions for connecting and operating supplied with each set. No experience necessary. The three and four tube sets have cut-out switch and first stage phone jack. Each set completely built, thoroughly tested and factory guaranteed.



All the Proof you want is waiting for You!

Reports from the many users in every state prove Miraco Tuned Radio Frequency Receivers—at rock bottom prices—have efficiency of sets costing up to three times as much. Remember that Miraco Sets are the product of a long established, reputable manufacturer—pioneer builders of sets. Send for further evidence that they are Radio's finest moderately priced receivers. All Miraco sets bear the endorsement of radio's highest authorities. Mail coupon now for latest bulletins and plenty of additional testimony from users leaving no doubt that "Miraco Radio Gets 'em Coast to Coast."

DEALERS! JOBBERS! Write for the new Miraco proposition. Nation-wide use and popularity of Miraco Sets, their amazingly low prices and our extensive advertising, makes them wanted everywhere. Send coupon. **AGENTS!** The wonderful tone, volume and distance-getting ability of Miraco Sets makes them easy to sell. Send coupon for proposition; good territory open.

Send coupon for free bulletins or order direct from this ad

MIDWEST RADIO CORPORATION
Pioneer Builders of Sets
Cincinnati, Ohio

414 K East Eighth Street
Send free literature, SPECIAL OFFER and all particulars regarding Miraco Sets. () Jobber. () Dealer. () Agent. () User.

Name

Address

CIR-KIT brings these Greater Circuits



Erla Push-Pull Transformer is exclusive in core design and shielding. Indispensable for safe operation of high resistance loud speakers under full power. \$10 pr.

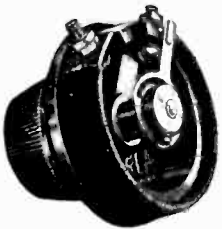

Only the special spring arm, the perfected bearing and winding of Erla Precision Rheostats permit such supersensitiveness. Single-hole mounting. Price, \$1.10.



Neatest, most convenient in form. Erla Autogrip 2-Way Phone Plugs assure smoothest connection of tips and most positive contact, with no manipulation. 75c.

In a motor car—the engine. In a skyscraper—the substructure. In a radio receiver—the circuit. The circuit, Erla knew, must be the foundation of finest possible radio. So Erla first evolved those circuits which have ever since been rated inherently more powerful, tube for tube. Today's trend clearly indicates that Erla Supereflex may be selected in full confidence of continued pre-eminence.

That these fundamentally superior circuits are also easiest to construct, with utmost economy, is another Erla attainment, made possible by the Erla CIR-KIT. With CIR-KIT anybody can construct Erla Supereflex circuits from genuine Erla apparatus, specially designed to assure most efficient functioning of Erla Supereflex principles.

Erla CIR-KIT supplies everything needed, in a factory-sealed carton, sold under warranty. Erla Synchronizing Transformers, Erla Miniloss Condensers, Erla Precision Rheostats, Erla Cushion Spring Sockets, Erla Tested Crystals, and all the other matchless Erla units are provided. You can assemble them with perfect results virtually guaranteed by full-sized blueprints, drilled and lettered panel, stenciled baseboard, precisely locating every unit and connection. There is no soldering, thanks to Erla Solderless Connectors. Pliers and screwdriver alone are needed to bring you the de luxe radio of Erla Supereflex circuits, at lowest possible cost.

Electrical Research Laboratories
Dept. H, 2500 Cottage Grove Ave., CHICAGO

Coast Representatives: Globe Commercial Co.
Los Angeles, San Francisco, Seattle

ERLA

clear of the rocks—don't fight it. Then straight in. Sand beach to the south of the Point."

"Yes, sir." Stripped, Jasmine revealed a pair of broad, tanned shoulders; slim hips. Eager hands fastened the line about his bare waist, making sure that the knot was one which would not tighten. For a moment he poised, erect, on the stern rail, then dived cleanly out and down to the water thirty feet below. He came to the surface gasping; the icy water had bitten into his flesh like so much liquid fire. He felt a strong current pulling him toward the reef, struck out across it, and two or three minutes later was in a second one which moved southward, as the captain had predicted. He saved his strength as much as possible, knowing that all would depend on the long pull straight inshore.

This was nothing like swimming in quiet water. One—two. One—two. He counted his strokes, choking as waves caught and flung him; half-blinded by the salt water. He could not breathe—gaped and found himself coughing, with hot salt in his nose. One—two. One—two. His shoulders ached already. The current lessened. He ventured a quick glance to the left. Pretty close to the rocks. Now or never, though. A long pull—a long pull.

Fifteen minutes later a rolling breaker caught him and threw him, half-unconscious, upon the sand. As he felt the gritty stuff on his bare knees the idiotic thought came to him that never, if anybody asked him to do a thing like this again, would he do it. He crawled forward—five feet—ten feet—to where the sand was dry, and, flat on his back, began hauling in the line, to which was attached a heavier one, spitting brine meanwhile. Men from the Government Station found him there, still hauling, and took the line from his hands. They wrapped Jasmine in a blanket, thinking that he would immediately become unconscious.

Boles was the first man to come ashore in the breeches buoy. The Coast Guard men looked at him, saw he was all right, and forgot him. Jasmine in his blanket saw him from beneath salt-swollen lids, and remembered. Remembered what he had been about to say when the *Merced* struck, that is.

Like a flash he was on his feet, and also on Boles, before that worthy quite knew what was happening. When Boles saw the livid face of the man before him, however, he knew instantly, and had sense enough to put up his hands before Jasmine's first left hook caught him on the ear and removed a portion of it for ever more. He led with his left, ponderously, as a big man should not do, but usually does, and Jasmine crossed to the chin with his right and

Continued on page 64

RADIO INSTITUTE OF AMERICA

TRAINING IN ALL COMMERCIAL BRANCHES OF RADIO

If you cannot attend the Radio Institute of America in person the same instruction can come to you through our recently inaugurated "HOME STUDY COURSE"—Investigate.



Detailed information free on request.

Conducted by

THE RADIO CORPORATION OF AMERICA

28 Geary St.
98 Worth St.

Phone Garfield 4200
Phone Franklin 1144

San Francisco, Calif.
New York City

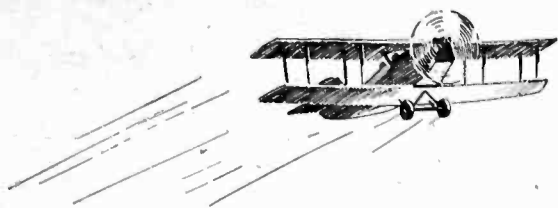

Bringing to earth the airplane type receiver

RADIO frequency transformers as designed by Jackson H. Pressley, Chief Engineer, Radio Laboratories, U. S. Signal Corps, Camp Vail, New Jersey, and manufactured by the Sangamo Electric Company, assure you of precision instruments.

The essential needs for airplane use are:

First—Extreme compactness with maximum amplification per transformer stage;

Second—A transformer so designed that there is negligible coupling between stages no matter how they are spaced;

Third—Stability without the aid of manual controls.

It was only after months of experimenting that Mr. Pressley was able to attain these results, and the adoption of his transformers as standard for airplane use speaks for itself.

A set of these radio frequency transformers and coupler coil will be delivered anywhere in the United States for \$22.50.—(Introductory Price)

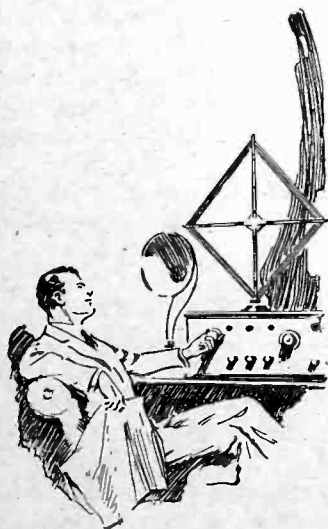

ASSOCIATED SANGAMO ELECTRIC COMPANIES

CAPACITY 3500 METERS PER DAY

SANGAMO ELECTRIC COMPANY
Springfield, Illinois

BRITISH SANGAMO COMPANY LIMITED
Pondersend, Middlesex, England

SANGAMO ELECTRIC COMPANY OF CANADA LIMITED
Toronto, Ontario

ASHIDA ENGINEERING COMPANY
Osaka, Japan

88-0-1

Domestic Offices—New York, Chicago, Birmingham, San Francisco, Los Angeles. Radio Division—50 Church Street, New York

Tell them that you saw it in RADIO



You can make it come in clear

THERE'S a lot of satisfaction and enjoyment in perfect reception. Yet it does not come merely with having a good loud speaker.

It's the work of Jefferson Transformers to provide full, smooth amplification—furnish the loud speaker with the proper energy so as to assure the greatest volume consistent with purity of tone.

Proper design prevents howling and distortion. You want more than noise from your loud speaker; that's why Jeffersons are made to a ratio which assures clarity.

Even amplification over the entire musical range, perfect reproduction of the voice or instrument—these are some of the reasons why radio authorities and music lovers the world over are recognizing the superiority of Jefferson Transformers.

Designed by a concern with over 20 years experience in the manufacture of high grade transformers of all descriptions. Jefferson Transformers meet matched construction specifications.

Ask for our latest Jefferson circuits including full details for building the Jefferson Baby Grand Superheterodyne (6 tubes). Write today

JEFFERSON ELECTRIC MFG. CO.
424 South Green Street, Chicago

Manufacturers of

- | | |
|----------------------------|------------------------|
| Bell Ringing Transformers | Gas, Furnace and Oil |
| Sign Lighting Transformers | Burner Transformers |
| Automobile Ignition Coils | and Ignition Equipment |
| Testing Instruments | Toy Transformers |
| Jump Spark and Make and | Low Voltage Auto |
| Break Ignition Coils | Transformers |

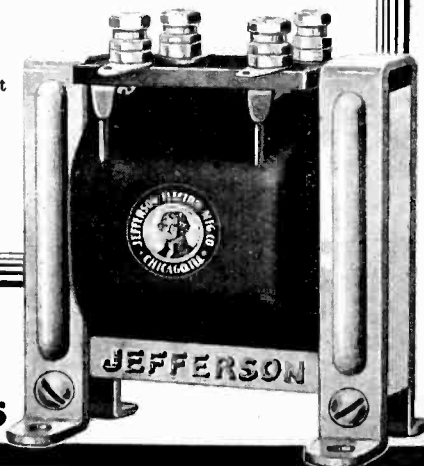

Jefferson Transformers

Continued from page 62

jabbed twice to the stomach—it was a nice fat stomach; too fat—before he could recover.

What can one do with an opponent who dances about madly, singing snatches of popular songs, and, peering from beneath swollen eyelids, lands blows from nowhere in particular upon parts very particular?

Jasmine never remembered that fight. Boles remembered only the first part of it. The crew, as they came ashore a man at a time, stood and watched with gaping mouths, and to their eternal joy they remembered, between them, all of it.

BOLES lost, they say. At least his doctor bill was over two hundred dollars including the trained nurse. Jasmine was only in a hospital ten days, upon each and every one of which he was visited by at least half of the crew, who brought him presents of candy that would have killed a well man, and perfume that would have raised a corpse. Wo Sin and the skipper came oftener and brought less.

And thus passed the Jonah of Jasmine Bjones, which might have been his name, and might also have been that inferiority complex.

Oh, yes! One more thing! The crew had still another method of proving to Jasmine that he had really and truly won his first fight. "That Fight," they call it, even today. They say that when Sweaty came ashore, the last to come before the captain, and saw Boles lying there on the wet sand and Jasmine standing, knocked clean out on his feet and too stupid to know it,—they say that when Sweaty came ashore and saw all this, he marched gravely over to Boles and looked for a moment down into his face, or what had been his face under normal conditions. Then, they say, he raised his head and squawked dismally:

"Arr-rk-kk! It's terrible, terrible, terrible!"

COMMERCIAL TESTING

Continued from page 21

oscillation occurs. Here, as in the detector unit, it should be possible to make the set oscillate and to prevent it from oscillating over its entire wavelength range.

Fig. 5 shows an audio-frequency amplifying unit used together with a tuning unit and a detecting unit. This circuit operates on the linear portion of the vacuum tube characteristic, a grid bias or C battery being sometimes necessary to bring the operating point on the linear portion for the particular plate voltage used.

The tests made on an audio-frequency amplifier consist of an amplification test and a noise test. The amplification test is the same as that made on radio-fre-

Continued on page 66

SILVER Super-Heterodynes

Outperform Them All!



Laboratory Model

DELHI, N. Y., and KGO again

LAST MONTH

Mr. George C. Cannon wrote . . . Silver Super adjusted . . . fine test run . . . all reasonable stations received on loud speaker . . . Brought in KGO with loud speaker volume on an 18" Loop four consecutive nights . . .

NOW

Mr. Cannon reports . . . Have received KGO (Oakland) on Silver Super here in Delhi, N. Y., every night that they have transmitted for the past two weeks . . . Wonderful volume . . . loud speaker on 18" Loop.

Silver Supers All over the country are rolling up similar records in routine performance . . . records not matched by any other receiver. Silver Supers do outperform the best of them . . . regardless of make and price. They're easy to build—all you need is a screw driver, soldering iron and a pair of pliers.

Get this Book—



"The Portable Super-Heterodyne"

It puts into your hands the results of Mr. Silver's experience with hundreds of Supers—dope never before available. Drawings and photographs show how all the "kinks and twists" have been eliminated, and make it easy for anyone to build either model Silver Super on the kitchen table. Price.....50c

Order Your Copy Today

Parts { Portable Model \$57.65
Laboratory Model \$63.60

Mail Orders a Specialty.
Shipments Prepaid East of the Rockies

ANNOUNCEMENT

Watch for the 4-Tube Silver Knockout Set— it's a wonder! On a 70-foot antenna, it will equal the performance of the Silver Supers—the record-breaking receivers that get Sea to Sea with loud speaker volume on an 18" Loop. Write for complete details.

FREE The "WHY of Silver Supers" —the book of facts on the 7-Tube Wonder sets that are breaking all records. Send for a copy today—It's free!

SILVER SUPER SPECIALS

Bring Your Old Super-Heterodyne Up-to-Date



Type 101
Silver Coupling Unit
150 to 600 meters
Small, compact and ultra efficient. Price (with mounting screws).....\$2.50

Type 201
Silver Tuned Output Transformer
30 Kilocycle
The filter that gives your amplifier real selectivity. Price (with mounting screws).....\$3.50

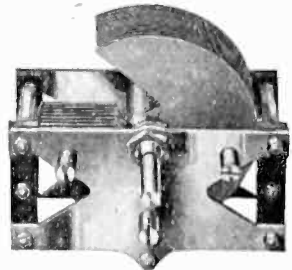

Type 301
Silver Low Condenser
Cap. .000009 to .0005
Loss so low as to be immeasurable. Ideal for any circuit. Price.....\$4.50

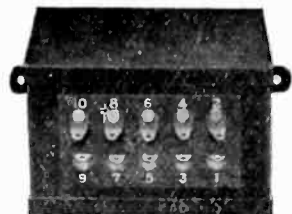

Type 401
Silver Transformer Unit
50 Kilocycle
Employs two inter-stage and one filter transformer, 1½ to 3½ times more efficient than anything on the market. It is the Original. Price.....\$14.00



Type 501
Silver 5-Gang 100 Socket
For panel and base mounting, with rubber cushions. Price.....\$3.00

Type 601
Silver Tapped Loop
A really efficient collapsible Loop with center tap. Price.....\$6.50

DEALERS—Write for our attractive merchandising plan.

Eastern Distributor—Twentieth Century Radio Corp., 102 Flatbush Ave., Brooklyn, N. Y.

Silver-Marshall, inc.

105 S. Wabash Ave.

Dept. D

CHICAGO

The Difference They Make in Reception is Amazing

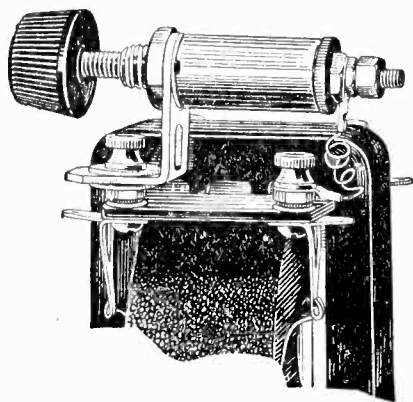

ELECTRAD AUDIOHM Eliminates Distortion

Also whistles, squeals and howls. Assures clear-cut, smooth reception of all notes of music and voice—bringing out the true, actual values of each tone. Reproduces all notes without blur or falsetto exaggeration.

You mount the Audiohm across the secondary of your audio transformer. Can be attached in a minute, and without solder. Easy to operate as setting your watch. Fits any transformer—and lasts for years.

Buy an Audiohm today and get perfect reception. We guarantee results. Price only \$1.50.

A Perfect Variable
Grid Leak.



ELECTRAD VARIOHM

Gives that Last
Hair's-breadth Tuning

Permits you to get stations you never heard before. Clears up those stations you have heard only indistinctly. Affords that super-fine tuning which every discriminating fan has long been seeking.

The Variohm is a wonderful, variable grid leak that works with exquisite precision. Allows infinitely fine variations of adjustment from $\frac{1}{4}$ to 10 megohms, and coarser adjustment from 10 to 30 megohms.

Install a Variohm in your set today—and get the fullest power, clarity and distance from it. Guaranteed. Price \$1.25 unmounted, \$1.50 mounted.

Electrad Audiohms and Variohms are on sale at most good radio stores
If your dealer doesn't carry them, order direct, and give his name.

ELECTRAD

428 Broadway, New York City

RADIO TUBES REPAIRED

UV-199, C-299, UV-201A, C-301A..... **\$2.00**

WD-11, WD-12, C-11, C-12, UV-200, C-300 **\$2.50**

NEW TUBES: The famous German Radex, Models 201-A and 199 only, both tipless, each..... **\$2.85**

Our products are inspected and recommended above all others by Volney G. Mathison, feature article writer for the Radio Magazine. All work is done by experts in one of the largest vacuum-tube laboratories in the world, and no expense has been spared to get results. We are the largest and best known refilling operators in the West. Send us your burnt-outs and get refills that are absolutely equal to your old tubes.

Burnt-out Cunningham and Radotron Tubes bought, 15 cents each.
GENERAL OFFICES NOW IN OUR NEW ENLARGED QUARTERS.

660 Twelfth Street, Oakland, California

S. P. HANKINS & COMPANY

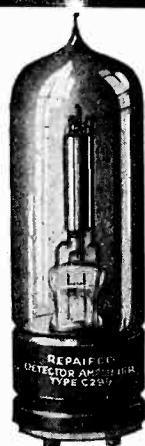

Continued from page 64
quency amplifiers except, of course, that there is no potentiometer used. The purpose of the noise test is to make certain that with no signals coming in (the wavemeter shut off) the noises introduced in the phones by the vacuum tubes used are not too great. Often, the ratio of signal to interference is very much reduced due to amplifier noises, a condition which evidently is quite undesirable.

SUPER-HETERODYNE

Continued from page 14

wood spools, each with two slots for the windings, one slot being $\frac{1}{4}$ in. and the other $\frac{1}{2}$ in. in width. The principal dimensions of the spools are given in Fig. 4. A hole $\frac{1}{2}$ in. in diameter should be bored in the center of the spool, for the core. The primary winding should consist of 450 turns of No. 30 D. S. wire, wound in the $\frac{1}{4}$ in. slot. No particular order should be observed in winding the coil, the wires being placed in a haphazard manner to reduce the distributed capacity effects. The secondary winding should be 2,100 turns of No. 36 single silk wire, wound in the $\frac{1}{2}$ in. slot. For the core material, use either a bundle of fine iron wires, such as No. 36 gauge, or a bundle of flat strips of silicon steel, not over .003 in. in thickness. Ordinary heavy transformer iron or silicon steel will not do. The thinner the laminations the better the transformer will be. Small lugs should be provided for terminals, the inside primary lead going to the plate, outside primary to the B battery, inside secondary to the filament and outside secondary to the grid, in each transformer.

The single tuned transformer is wound on a spool, turned from seasoned hardwood with flange $\frac{1}{4}$ in. in width, a diameter of $2\frac{1}{2}$ in., a hub of 1 in. and a slot $\frac{1}{2}$ in. in diameter. On this spool wind 250 turns of No. 30 D. C. C. wire, in a haphazard manner. Place a layer of insulating paper over this winding, and wind on 1600 turns of No. 36 single silk or enameled wire, for the secondary coil. If this transformer is used in the circuit, the primary condenser should be .005 mfd., and the sec-

Continued on page 68

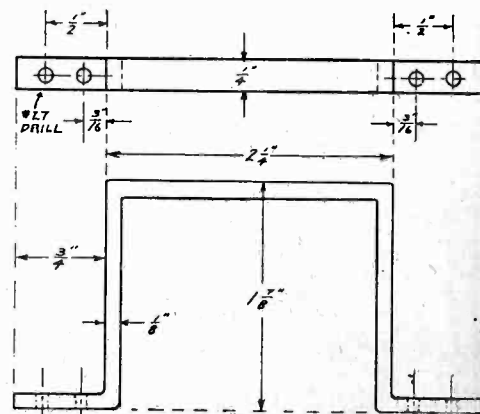
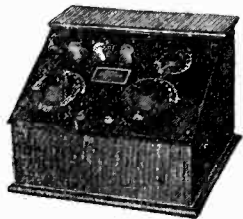

Fig. 5. Dimensions of Shelf Supports

Ware NEUTRODYNE Receivers

They're All Talking About the Ware



TYPE T

Mahogany cabinet, 10 $\frac{1}{4}$ " high, 14" wide, 13 $\frac{1}{2}$ " deep. Dry-cell "A" and "B" batteries enclosed in cabinet. Reflex Neutrodyne circuit. Three dry-cell tubes, one reflexed; equivalent to four-tube circuit; one stage tuned radio frequency amplification, detector, two stage audio. Operates loud speaker. Outside antenna.

\$65.00 without accessories

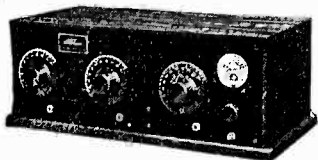

TYPE X

Walnut cabinet, 8 $\frac{1}{2}$ " high, 21 $\frac{1}{2}$ " wide, 10 $\frac{1}{4}$ " deep. Dry-cell "A" and "B" batteries enclosed in cabinet. Reflex Neutrodyne circuit. Four dry cell tubes, one reflexed; two stages tuned radio frequency amplification, detector, two stages audio, equivalent to five tube circuit. Double-sealed voltmeter indicates voltages of "A" and "B" batteries. Indoor or outdoor antenna.

\$150.00 without accessories

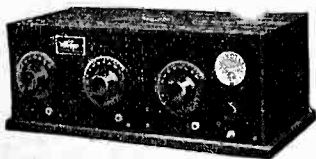

TYPE W

Walnut cabinet, 8 $\frac{1}{2}$ " high, 21 $\frac{1}{2}$ " wide, 10 $\frac{1}{4}$ " deep. Neutrodyne, not reflexed, using five vacuum tubes—two radio, detector, two audio—and storage battery, "B" batteries enclosed in cabinet. Double-sealed voltmeter indicates voltages of "A" and "B" batteries. Indoor or outdoor antenna.

\$175.00 without accessories.

Progressive Musical Instrument Corp.,
New York, N. Y.
Dalrymple-Whitney Radio Corp.,
New York, N. Y.
Cohen & Hughes, Inc.,
Philadelphia, Pa.
Pittsburg, Pa.
Baltimore, Md.
Washington, D. C.
Illinois Phonograph Company
Chicago, Illinois
Yahr & Lange,
Milwaukee, Wis.

Ohio Musical Sales Co.,
Cleveland, Ohio
Lucker Sales Company,
Minneapolis, Minn.
New England Phonograph
Distributing Co.,
Boston, Mass.
Commercial Associates, Inc.,
Los Angeles, Calif.
D. H. Holmes Co., Ltd.,
New Orleans, La.
Mickel Bros. Company,
Omaha, Nebraska

Kohler Distributing Co., Inc.,
San Francisco, Calif.
Knight-Campbell Music Co.,
Denver, Colorado
Kiefer-Stewart Co.,
Indianapolis, Indiana
Gibson-Snow Co., Inc.,
Syracuse, New York
J. W. Jenkins' Sons Music Co.,
Kansas City, Mo.
C. A. Richards Inc.,
(Foreign Distributors)
New York, N. Y.

Ware
RADIO CORPORATION
529-549 WEST 42ND STREET
NEW YORK

DISTRIBUTORS

And why shouldn't they talk about the Ware? To hear any one of the Ware models is to have a new radio experience. You will say that you never heard such tone in a receiver.

There is a type to suit every one—from the Type T, a three-tube Reflex Neutrodyne, priced at \$65, without accessories, to the Type WU, a standing cabinet model so beautiful that it will fit into the decorative scheme of the finest home, priced at \$300, without accessories.

The illustrations will give you an idea of what the various models are like, but really to know just what they will do, you must hear them. You can then form your own conclusions as to appearance, quality of tone, range and any other characteristics that you feel your radio set ought to have.

Be sure to ask your dealer for a demonstration of Ware Neutrodyne receivers. They are their own best salesmen.

Send for Catalog



TYPE TU

Brown mahogany or walnut cabinet, housing Type T circuit. Panel exposed by raising lid. Loud speaker concealed behind grille. Dry cell "A" and "B" batteries enclosed in cabinet. Dimensions: 34 $\frac{1}{2}$ " high, 18 $\frac{1}{4}$ " wide, 18 $\frac{1}{4}$ " deep.

\$150.00 without accessories.



TYPE XU

(See WU for cabinet open)

Brown mahogany or walnut cabinet, with panels of contrasting shades. Embodies Type X circuit. Loud speaker concealed behind grille at top, below which a desk leaf turns down, exposing the panel. Dry cell "A" and "B" batteries enclosed in cabinet. Dimensions: 44" high, 27 $\frac{3}{4}$ " wide, 18 $\frac{7}{8}$ " deep.

\$275.00 without accessories.

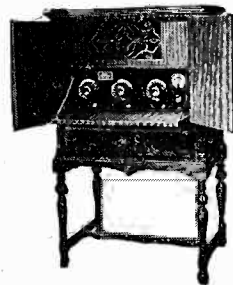

TYPE WU

(See XU for cabinet closed)

Brown mahogany or walnut cabinet, with panels of contrasting shades. Embodies Type W circuit. Loud speaker concealed behind grille at top, below which a desk leaf turns down, exposing the panel. Storage and dry cell batteries enclosed in cabinet. Dimensions: 44" high, 27 $\frac{3}{4}$ " wide, 18 $\frac{7}{8}$ " deep.

\$300.00 without accessories

Licensed by the Independent Radio Manufacturers, Inc., under Hazeltine Patents Nos. 1,450,080 and 1,489,228 and patents pending, and the trademark "Neutrodyne" registered in the U. S. Patent Office, Certificate No. 172,137

Continued from page 66

ondary condenser should be omitted. The four leads from the windings should be terminated in a manner similar to that described for the untuned transformers.

Assembly of Parts

ON the baseboard, which is 10x19x 1/2 in., lay out the various parts as indicated in the drawing, without fastening the panel to the board until all the assembly work, and some of the wiring, is completed. The additional template for the tube shelf will indicate the size of the fittings, and in Fig. 5, dimensions are given for the two brass legs necessary to support the shelf. It will be seen that mounting the sockets on the shelf will greatly shorten the

baseboard and shelf, with wood screws. Most condensers are now supplied with soldering lugs, making the work of soldering easy. Clips for mounting C_0 are supplied with the transformer so that it will be suspended directly alongside. The bakelite strip for mounting the three loop binding posts is shown in Fig. 7 and should be screwed to the tube shelf back of the oscillator and first detector tubes.

The use of No. 14 or No. 16 gauge tinned square wire is recommended, as the wiring will thus be rigid, and in most cases spaghetti will not be needed. In cases where it is apparent that some of the wires may touch, spaghetti insulation should be employed, but not

otherwise. There will be rather long leads from the second detector tube to the first audio frequency transformer, and it is suggested that these leads be run in twisted pair, using a convenient size of twisted bell wire or other good insulated wire.

For those who do not wish to use the large tube in the last stage, an alternative arrangement in Fig. 8 gives the wiring diagram of the audio stages with 3-volt tubes throughout.

Testing the Set

AFTER all wiring is finished, an accurate check of all connections should be made before inserting the tubes in the sockets or connecting the batteries.

Connect the loop or antenna coupler to the three binding posts at the left end on the rear of the baseboard, the center tap being connected to the center binding post. One of the outside loop terminals should be connected to the binding post and the other to the lower, the two connections being reversible without causing any change.

The B batteries should now be con-

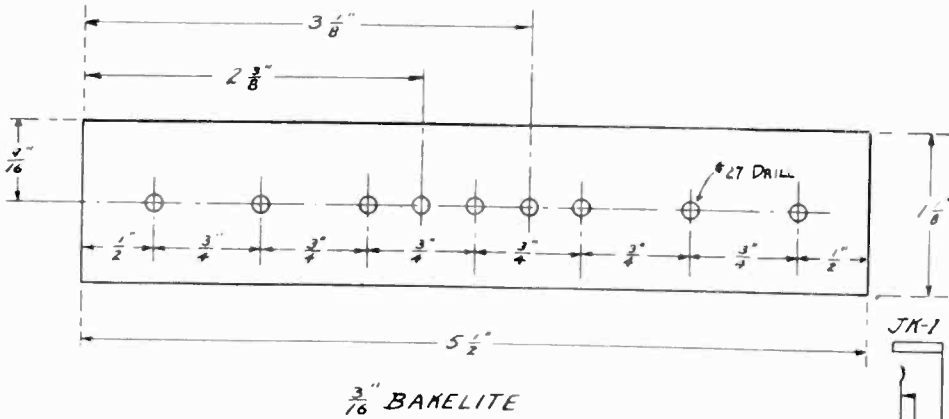

Fig. 6. Mounting for Battery Binding Posts

leads to the transformers, as well as provide additional space underneath for other apparatus.

After drilling the panel, the two condensers, voltmeter, rheostats, Chelton condenser, rheostats, jacks and filament switch, may be mounted. As much of the wiring as possible should be completed before fastening to the baseboard.

The tube shelf should be mounted last, after all the connections to the apparatus underneath are run. The C battery is held in place by a piece of heavy copper wire fastened at each end by screws to the tube shelf. The bakelite strip for mounting the battery binding posts is indicated in Fig. 6, and is mounted at one end of the tube shelf with two wood screws. The fixed condensers may be screwed directly to the

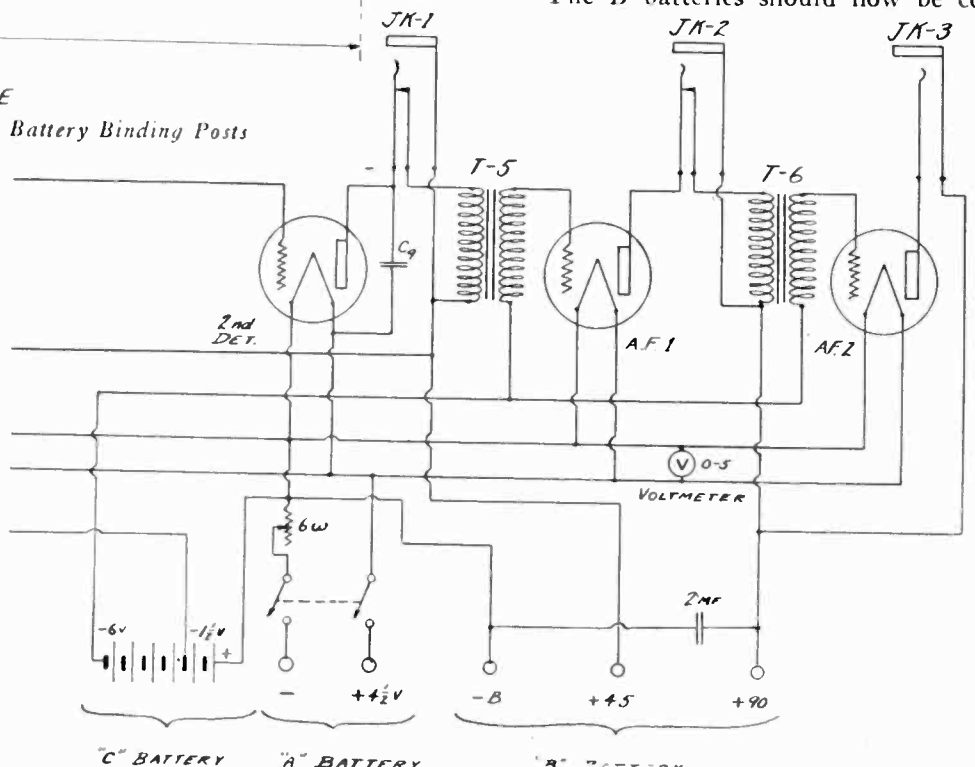

Fig. 8. Alternative Wiring Diagram for 3-Volt Tubes in A. F. Amplifier

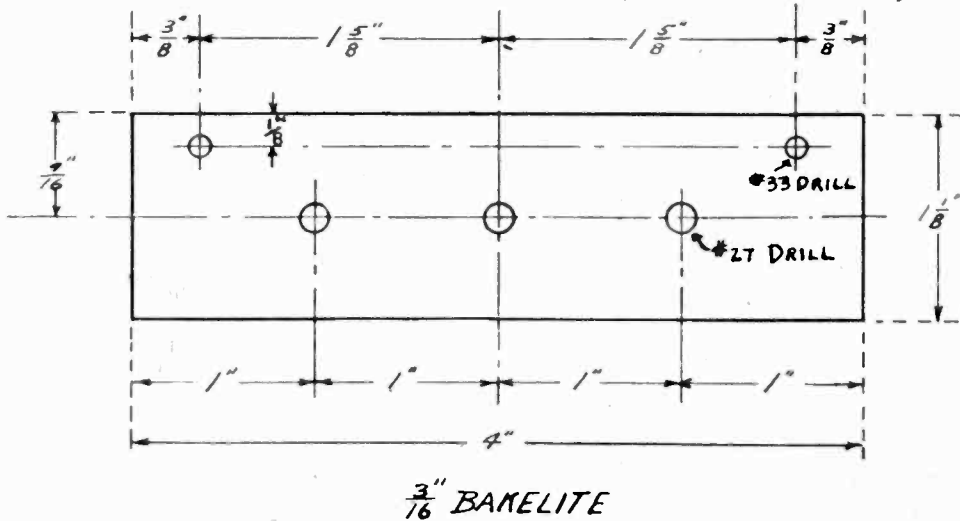
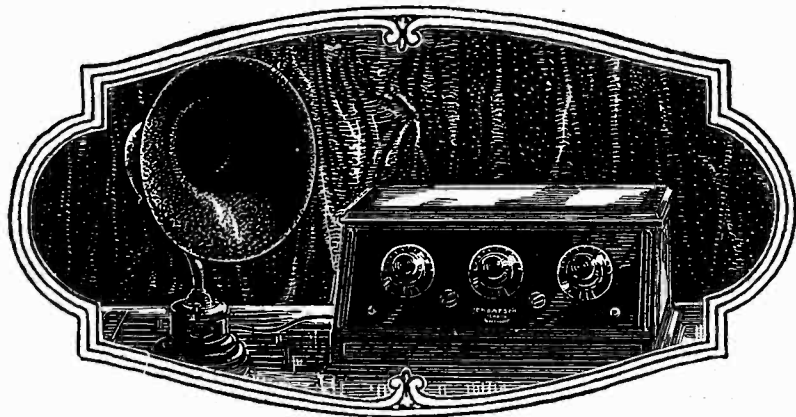

Fig. 7. Mounting for Loop Binding Posts

nected to the terminals, the battery consisting of two 45-volt units and a 22 1/2-volt unit, the latter providing extra voltage for the last audio tube only. After connecting the batteries in series, connect the negative terminal to the binding post marked -B, bring out a tap at 45 volts, connecting the tap to +45 binding post and take out another tap at the second 45-volt point to provide 90 volts. The final tap, 112 1/2 volts, goes to the binding post at the extreme end of the strip and should under no circumstances be allowed to touch any other part of the circuit.

After the B battery has been attached, plug in the phones or loud speaker in

Continued on page 70



"Experience is the Vital Factor in Excellence"

THOMPSON RADIO

THE Thompson Organization is unique among radio manufacturers in having a background of 15 years experience in designing, developing and manufacturing intricate and delicate radio apparatus for the armies, navies and commercial institutions of the world.

During this time its research laboratories have perfected developments which have contributed largely to the advancement of the radio industry.



This wide experience, now available in the Thompson apparatus, means Receivers and Speakers that embody the latest and best practice in Radio Engineering. A critical investigation of each model will disclose outstanding features of genuine excellence — in artistic appearance, naturalness of tone, simplicity of operation

Thompson Receiving sets range in price from \$125 to \$180. The Thompson Speaker is now \$28.

Write for attractive literature and name of Thompson dealer near you.

R. E. THOMPSON MANUFACTURING CO.
30 CHURCH STREET
NEW YORK, N. Y.

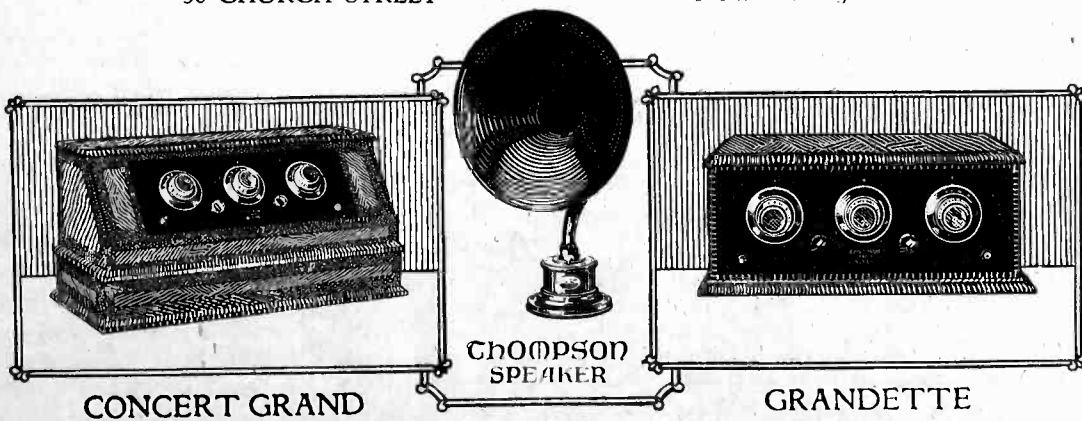

CONCERT GRAND

THOMPSON
SPEAKER

GRANDETTE

the last phone jack, turn on the filament switch and volume control rheostats, and watch the voltmeter for any deflection. If such deflection occurs, an error in the *B* battery wiring has occurred, and the trouble should be located and cleared before the tubes are placed in their sockets.

If no deflection of the voltmeter needle occurs, the *A* battery can be connected. This should consist of four dry cells, or more if a parallel arrangement is desired, the first three cells providing the necessary voltage for the 3-volt tubes and the fourth cell providing an additional $1\frac{1}{2}$ volts for the C-301-A tube. Turn on the filament rheostat and see that the voltmeter reads $4\frac{1}{2}$ volts. If it does, the wiring in the battery circuits is correct, and the tubes may now be inserted. If trouble appears, in the shape of a deflection of the needle off the scale, the *B* battery is crossed with the filament circuit somewhere, and the trouble must be located before inserting the tubes.

After mounting all the tubes in their sockets, turn on the filament rheostat, and adjust the voltage to 3 volts. Be sure to turn the volume control rheostat as far to the right as it will go when making the adjustment. Next it will be necessary to adjust the fixed resistance in the C-301-A tube. This tube should have a voltage of 5 across the filament, and as the battery will have a voltage of 6, a resistance of 4 ohms is necessary to cut the voltage to the correct value. The Amperite unit will provide this resistance automatically and needs no adjustment. An easy way to check the voltage is to disconnect the negative terminal of the voltmeter from the permanent lead running to it, and run temporary wires from this terminal to the lugs on the C-301-A tube socket. This will enable the voltage to be read without an extra voltmeter.

Adjustment and Operation

If everything is found to be O. K. the necessary adjustments are now in order. These adjustments should be made when a good radiocasting station, located within 100 miles of the receiver, is in operation. In normal operation, tuning is accomplished by means of the loop and oscillator dials, the volume being controlled by the volume control rheostat. The rotor of the coupling unit and the condenser C_{10} are adjustable, but once set should not be further adjusted unless a change is made either in the loop or tubes used. Set condenser C_{10} so that the stator and rotor plates are not inter-spaced. Set the rotor of the coupling unit half way between the minimum and maximum coupling positions.

Turn the volume control to its highest position and set the loop condenser

Continued on page 72

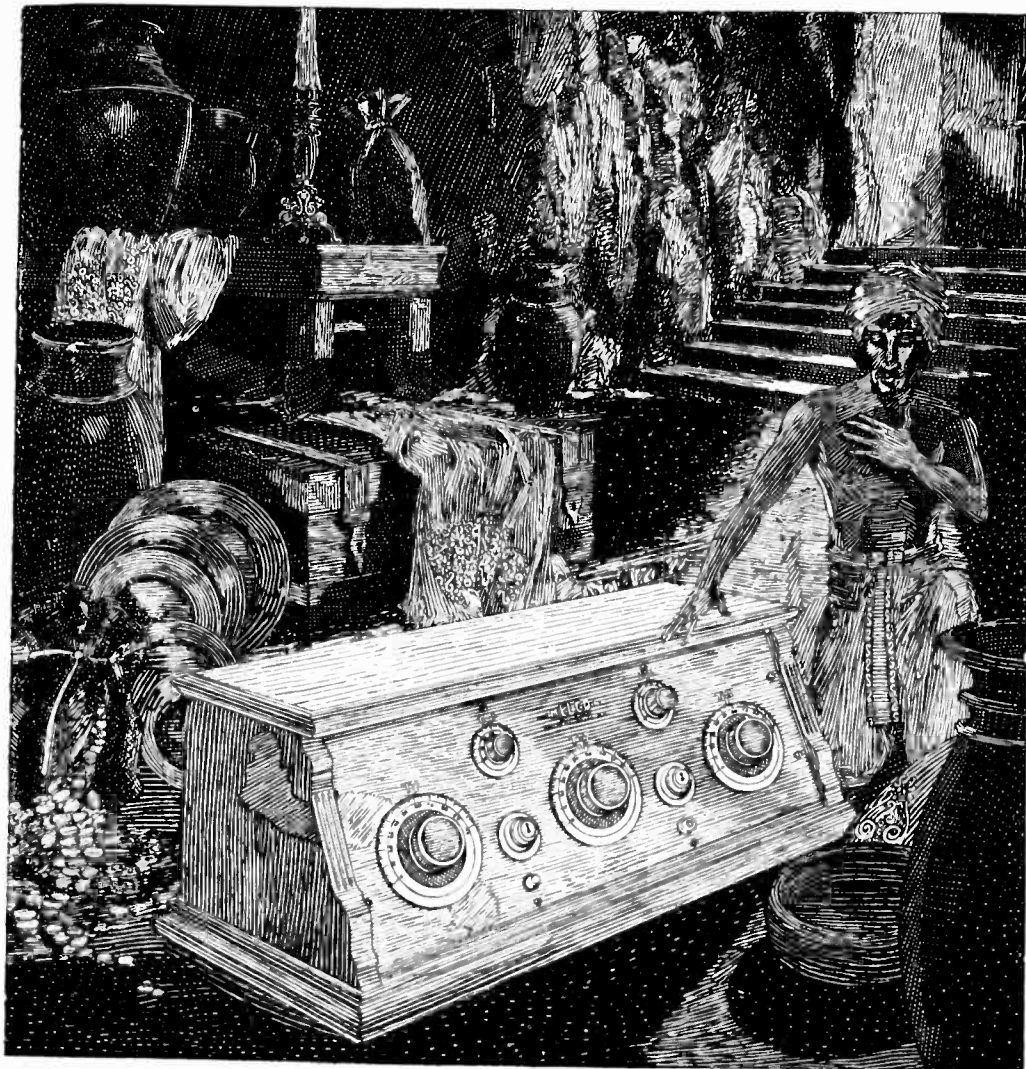

MELCO SUPREME--the "Open Sesame" that reveals the priceless treasures of the air! Melco reception is to the ear like a great, masterly-cut gem to the eye. Clear, Flawless, Supreme.

Ready for Distribution January 1, 1925.

MELCO SUPREME RECEIVER TUNED RADIO FREQUENCY

AMSCO PRODUCTS INC. BROOME & LAFAYETTE STREETS N.Y.

Write for Interesting Literature.



14-inch Bell
Polished Pyralin



Aluminum Sound Column

Burns A Speaker of Distinctive Lines

Full volume without sacrifice of clearness or naturalness. Reproduces true tones of voice or music. Equal to hearing the original.

No. 100 Speaker Unit supplied for phonograph use—fits any make.
No. 205B—Polished black flare.....\$22.50
No. 205D—Shell pyralin flare..... 25.00
No. 100 —For phonograph use..... 10.00

Manufactured by

American Electric Company
State and 64th Streets, Chicago

Earn \$5⁰⁰ to \$20⁰⁰ a Day in RADIO

You can! Hundreds of ambitious men are already earning thousands of dollars in this wonderful new industry—you, too, can get your share. Mail coupon below for Free Book which describes fully the amazing money-making opportunities in Radio and tells you how YOU can earn from \$5,000 to over \$10,000 a year.

The astounding growth of Radio has created thousands of big money opportunities. Millions of dollars were spent during the past year on Radio, and thousands of young men are needed right now to meet the ever-increasing demand of work.

Men are needed to build, sell and install Radio sets—to design, test, repair—as radio engineers and executives—as operators at land stations and on ships traveling the world over—as operators at the hundreds of broadcasting stations. And these are just a few of the wonderful opportunities.

Easy to Learn Radio at Home in Spare Time

No matter if you know nothing about Radio now, you can quickly become a radio expert, by our marvelous new method of practical instruction—instruction which

includes all the material for building the latest up-to-date radio apparatus.

Scores of young men who have taken our course are already earning from \$75 to \$200 a week. Merle Wetzel of Chicago Heights, Ill., advanced from lineman to Radio Engineer, increasing his salary 100%, *even while taking our course!* Emmett Welch, right after finishing his training, started earning \$300 a month and expenses. Another graduate is now an operator of a broadcasting station—PWX of Havana Cuba—and earns \$250 a month. Still another graduate, only 16 years old, is averaging \$70 a week in a radio store.

Wonderful Opportunities

Hardly a week goes by without our receiving urgent calls for our graduates. "We need the services of a competent Radio Engineer." "We want men with executive ability in addition to radio knowledge to become our local managers." "We require the services of several resident demonstrators"—these are just a few small indications of the great variety of opportunities open to our graduates.

Take advantage of our practical training and the unusual conditions in Radio to step into a big paying position in this wonderful new field. Radio offers you more money than you probably ever dreamed possible—fascinating, easy work—a chance to travel and see the world if you care to, or to take any one of the many radio positions all around you at home. And Radio offers you a glorious future!

The National Radio Institute is America's Pioneer Radio School—established in 1914. Our course is the absolutely complete one now being offered which qualifies for a government first-class commercial license. It gets you *bigger* paying jobs in Radio.

Send for **FREE RADIO BOOK**

Learn more about this tremen-



dous new field and its remarkable opportunities. Learn how you can quickly become a radio expert and make big money in Radio.

We have just prepared a new 32-page booklet which gives a thorough outline of the field of Radio—and describes our amazing practical training in detail. This Free Book, "Rich Rewards in Radio," will be sent to you without the slightest obligation. Mail coupon for it *now!*

For a short time we are offering a reduced rate to those who enroll at once. Act promptly and save money.

**National
Radio
Institute**

Dept. 10 MA
Washington,
D. C.

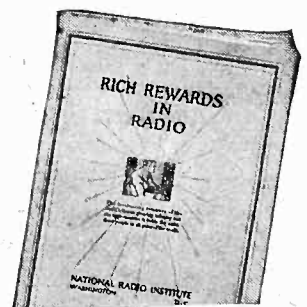

NATIONAL RADIO INSTITUTE
Dept. 10 MA Washington, D. C.

Please send me without the slightest obligation your Free Book, "Rich Rewards in Radio," and full details of your special Free Employment Service. Please write plainly,

Name.....Age.....
Address.....
City.....State.....

Pay Increases Over \$100 a Month

I am averaging anywhere from \$75 to \$150 a month more than I was making before enrolling with you. I would not consider \$10,000 too much for the course.

(Signed) A. N. LONG,
120 N. Main St.,
Greensburg, Pa.

Doubles Salary

I can very easily make double the amount of money now than before I enrolled with you. Your course has benefited me approximately \$3,000 over and above what I would have earned had I not taken it.

T. WINDER,
731 Belford Av.,
Grand Junction, Colo.

From \$15 to \$80 a Week

Before I enrolled with you I was making \$15 a week on a farm. Now I earn from \$2,080 to \$4,120 a year, and the work is a hundred times easier than before. Since graduating a little over a year ago, I have earned almost \$4000, and I believe the course will be worth at least \$100,000 to me.

(Signed)

GEO. A. ADAMS,
Route 1, Box 10,
Tamaqua, Pa.



FRESHMAN MASTERPIECE

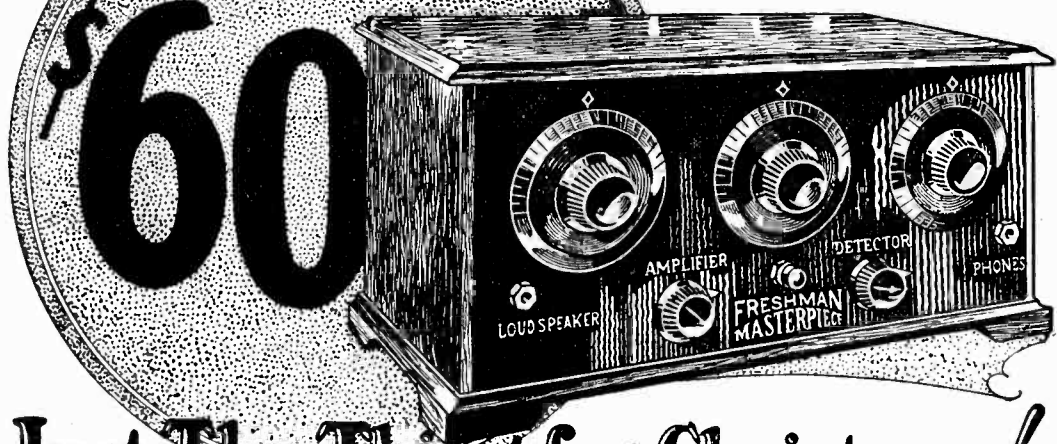

Just The Thing for Christmas!

A 5 Tube Tuned Radio Frequency Receiver

made of the finest low loss materials and in a beautiful genuine solid mahogany cabinet, that is attractive enough for the most pretentious room, and at sixty dollars, economical enough for the most modest. Users claim it is

*The Greatest Value Ever Offered
in a Radio Receiving Set*

Combines all points essential to the perfect receiver. Real distance reception without that squealing and howling. So selective that once a station is picked up—it can be brought in again on the same points on the dials, whenever you want it. And what's more,

All genuine Freshman Masterpiece Sets have a serial number and trademark riveted on the sub-panel. The Receiver is not guaranteed if number has been removed or tampered with.

*It's the Easiest Set In The World
To Operate*

Chas. Freshman Co. Inc.
Radio Condenser Products

240-248 W. 40th St., New York

Ask your dealer to install one in your home.

Beware of Imitations and Counterfeits.

at a point near the zero setting, say 15 degrees. Slowly turn the oscillator dial back and forth, from zero to 25 degrees, at the same time listening for signals. If none are heard, change the loop condenser setting to 25 degrees, and slowly move the oscillator dial through an arc from 10 to 40 degrees. This process should be repeated until a station is heard, changing the setting of the loop condenser about 5 degrees each time and slowly turning the oscillator condenser from a point at least 10 degrees below the loop setting to 10 degrees above the loop setting. When tuning distant stations, the same procedure applies, except that it will be necessary to make loop settings every two degrees or even less if the signal strength of the station to be received is weak.

When a station has been picked up, it will be noted that it can be received at two setting of the oscillator condenser, the lowest one on the dial being the adjustment of the oscillator that gives a beat frequency 45,000 cycles higher than the frequency of the incoming wave, and the upper dial setting being for a beat frequency 45,000 cycles lower than the incoming wave frequency. Signals should be received with about the same intensity for either setting, but often under conditions of interference from other stations, it will be found that one setting gives better results and less interference than the other.

If the volume from the station being received is too great, and distortion occurs, the volume can be lowered by cutting in resistance in the volume control rheostat. After one station has been received and the operator becomes familiar with the adjustment of the dials, others will be picked up more readily. Each time a station is heard the setting should be noted and marked for future reference. This is important not only for tuning in the same station at some other time, but to facilitate the location of stations whose wavelengths are known to be slightly above or below the station for which settings were recorded.

When a station at least 1,000 miles distant has been tuned in, the rotor of the coupling unit should be adjusted to as near a minimum position as is possible without causing a decrease in signal strength. Once this adjustment has been made, the rotor may be locked in place with the set screw provided for that purpose and need never be changed again throughout the life of the oscillator tube. When a new oscillator tube is used, it may be desirable to make the adjustment over again.

The adjustment of condenser C_{10} should be made while a station of low wavelength, between 200 and 300 meters if possible, is being received.

FROST-RADIO

Ask Your Neighbor

THE name **FROST-RADIO** on a piece of apparatus, whether **FROST-FONES**, Plugs, Jacks, Sockets, Rheostats, etc., means highest quality. Your dealer carries complete stocks. See him today.



HERBERT H. FROST, 154 W. Lake St., Chicago

RADIO MONEY SAVING CATALOG SENT FREE
TIMES SQUARE AUTO SUPPLY CO. INC.
BROADWAY AT 56TH ST New York

Your Crystal Set

will work 400 to 1000 miles if made by my plans. No tubes or batteries. Copyrighted plans \$1.00; or furnished FREE with complete parts for building set, including special coil and panel correctly drilled for only \$5.00. Satisfaction guaranteed or money refunded. Satisfied customers everywhere. Particulars free.

LEON LAMBERT
542 Kaufman Bldg. Wichita, Kansas

You Should Subscribe for "RADIO"

Pure, clear tones from your speaker, must start with your transformers

You want more than noise from your loud speaker.

You want *pure* tones, clear, mellow reproduction.

But no speaker can be *better* than your A. F. transformers.

And *any* speaker will be improved when you use transformers that are designed for loud speaker use!

Transformers that produce the greatest possible *amount* of amplification unfortunately also introduce imperfections in the tone. And the speaker magnifies such imperfections.

Fortunately, however, when the tone is *clear*, you don't need anywhere near so much *volume* of sound.

In designing MAR-CO transformers, an amplification ratio has been used, which provides the *most* volume that is consistent with absolute purity of tone. And, of course, they are built, like all other MAR-CO parts, with the famed MAR-CO precision that stops leaks and conserves radio energy!

So, now, those who value tone purity highly, will use two and sometimes three stages of MAR-CO amplification this Fall, and replace squeals with music!

MARTIN-COPELAND COMPANY
Providence, R. I.

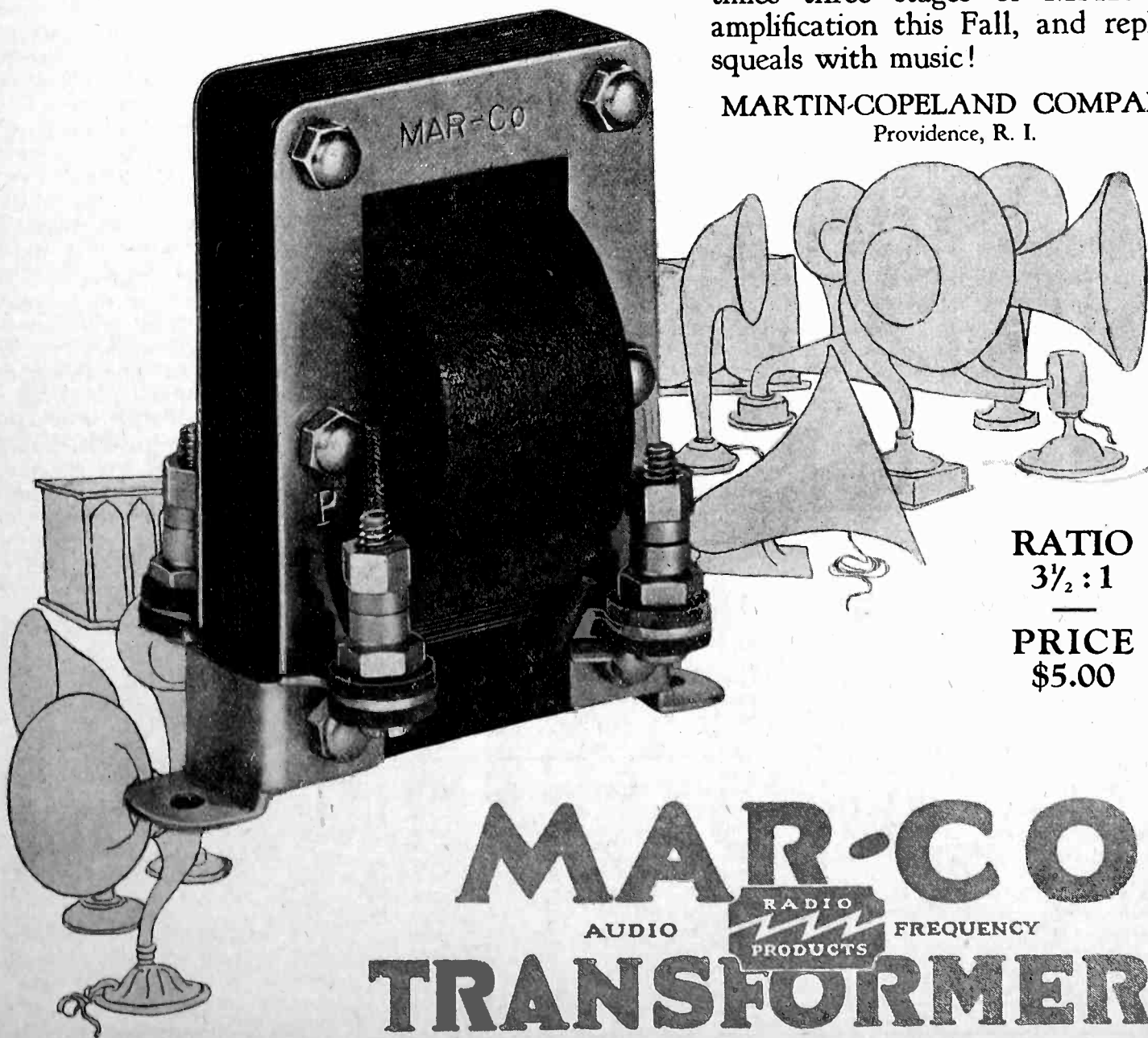

RATIO
3½ : 1
—
PRICE
\$5.00

MAR-CO
AUDIO  FREQUENCY
TRANSFORMERS

Tell them that you saw it in RADIO

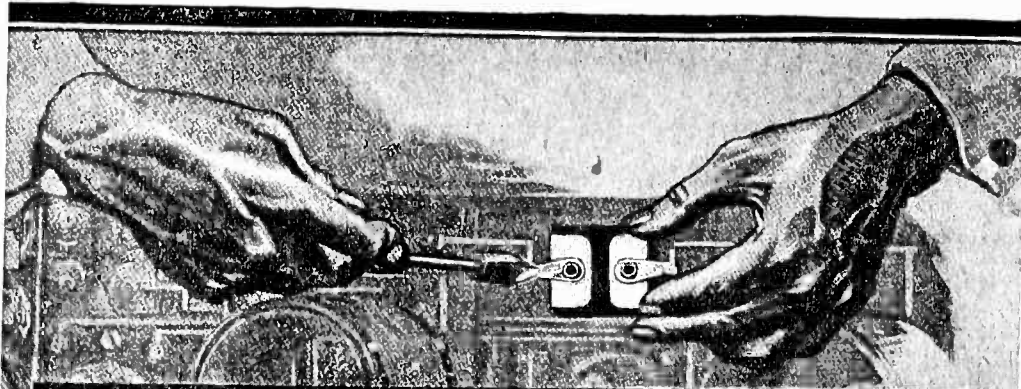

Nine Out of Ten Sets Use Micadons!

Nine out of every ten sets made use Micadons — the standard fixed radio condenser. Set builders choose them for many reasons.

They know that the Micadon is a Dubilier product, hence supreme in quality and efficiency.

They know that Micadons can be obtained in accurately matched capacities and that the capacity is permanent.

They know that Micadons are easily installed, equipped as they are with extension tabs for soldering and screw-eyes for set screw assembly.

They know that Micadons are made with type variations to meet every possible requirement.

For the best results use Micadons

Dubilier

CONDENSER AND RADIO CORPORATION

After the station has been tuned in satisfactorily and the volume adjusted so that the signal is audible, the condenser capacity should be increased until the set oscillates and the signal is destroyed. Then back off the setting of the condenser until oscillation ceases and signals of good quality are being received, and the adjustment is complete. Do not further adjust the condenser for higher wavelengths, as the set will surely oscillate when it is again tuned to the lower wavelengths, and the condenser will have to be adjusted again. It is there only to reduce the loop resistance to a small value and should not be used as a tuning control. It would be far better to do away with the condenser altogether rather than forever be making adjustments with it, as it would surely prove a detriment rather than a benefit in the long run if that were the case.

If, after carefully following the instructions for tuning the circuit, no signals are heard, and at a time when local stations are known to be transmitting, a series of tests should be made to locate the trouble. Touch the grid terminal of the oscillator tube socket, and if the tube is oscillating a click will be heard in the phones when the finger touches the terminal and again when it is withdrawn. If it is not oscillating, the click will be heard only when the terminal is touched, and not when it is withdrawn. Failure of the tube to oscillate can mean that the oscillator coil connections are wired incorrectly, that the tube is defective, or that the socket springs are not making contact with the tube terminals.

If the set oscillates continually at most settings of the volume control rheostat, the condenser C_{10} may be set at too great a capacity value. One of the grid leads in the intermediate frequency amplifier may be open, or the C battery is not connected properly in the circuit. An open C battery will cause oscillation troubles, and is often hard to find. Try placing the positive terminal of the voltmeter, which has been disconnected from the circuit, to the positive C battery, and touch the negative terminal of the voltmeter in turn to the grid spring of each tube socket. If a deflection is noted, there is an open between the C battery and the tube, probably in the transformer. The same method should be used for checking out the filament circuit, in case some of the tubes do not light.

A howling in the audio frequency amplifiers is probably due to coupling between transformers. If transformers other than those specified are used, particularly the high ratio type, it would be advisable to connect the cores of the two transformers to the negative A battery.

In regard to difficulty due to the

Continued on page 76

CARTER

Pat. 7-10-'23

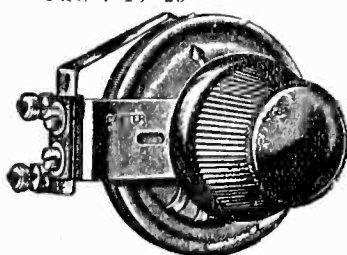

\$1.75

All Styles

VERNIER CONTROL Rheostat

CARTER originality has produced an entirely new design.

Smooth, positive, noiseless, with Vernier Control. Only one knob. One hole mounting.

Any dealer can supply.

Coast Distributors: Atlantic-Pacific Agencies Corporation, 204 Rialto Bldg., San Francisco

Write for Catalog



3-6-10-20-25-30 Ohms

Eveready Heavy Duty "B" Battery, 45 volts. Three Fahnestock clips. Length, 8 3/16 inches; width, 4 7/16 inches; height, 7 3/16 inches; weight, 13 3/4 pounds. Price \$4.75.



NO 770
EVEREADY
TRADE MARK REGISTERED
RADIO
"B" BATTERY
 30 CELLS 45 VOLTS
 This heavy duty 45 volt "B" Battery is especially designed to give longer service under heavy drain, and is particularly adapted for use with multi-tube sets, operating at 90 volts or more.
NATIONAL CARBON CO. INC.
HEADQUARTERS FOR RADIO BATTERY INFORMATION
 NEW YORK SAN FRANCISCO
 MADE IN U. S. A.

Dry "B" Batteries are more economical and more dependable than any other source of plate current!

REDUCE Operating Costs

THOUSANDS of people are already cutting their "B" Battery costs one-half, or even two-thirds, by using the new Eveready "B" Battery No. 770 on their heavy drain sets.

This new Eveready Heavy Duty Battery marks a marvelous advance in reducing "B" Battery costs.

If your "B" Batteries have lasted only two months on a five or six tube receiver, this Eveready Heavy Duty "B" Battery will increase the service two to three times.

Use this Eveready Heavy Duty "B" Battery on any receiving set on which the "B" Batteries last less than four months. When thus used to its full capacity, it is the cheapest as well as the best source of "B" energy ever offered.

Manufactured and guaranteed by
NATIONAL CARBON COMPANY, INC.
Headquarters for Radio Battery Information
 New York San Francisco
 Canadian National Carbon Co., Limited, Toronto, Ontario

EVEREADY
Radio Batteries
- they last longer

**SPAULDING—
BAKELITE**

Endorsed by

Andrews Radio Co.
C. D. Tuska Co.
Chelsea Radio Co.
Coto Coil Co.
Rawson Elec'l Instr. Co.
The Framingham Co.
Elec'l Products Mfg. Co.
Forest Electric Co.
American Mechanical
F. A. D. Andrea
Resas, Inc.
Magnus Electric Co.
R. E. Thompson
Dynamotive Radio Corp.
Ware Radio Corp.
Phenix Radio Corp.
Chicago Radio Laboratories
Operadio Corporation
Howard Radio Co.
H. G. Saal Co.
Krasco Mfg. Co.
Wells Mfg. Co.
Ferro Mfg. Co.
Joy Kelsey Corp.
Clapp Eastham Co.
De Witt LaFrance Co.
Cutler Hammer Mfg. Co.
Shepard-Potter Co.

**SPAULDING FIBRE
COMPANY, Inc.**

Factory—Tonawanda, N. Y.

SALES OFFICES - WAREHOUSES

484 Broome St., N. Y. C.
659 W. Lake St., Chicago
310 E. 4th St., Los Angeles
141 N. 4th St., Philadelphia
15 Elkins St., Boston
171-2nd St., San Francisco
501 First Nat'l Bank Bldg., Milwaukee

Specially Processed for RADIO

When you consider its source, you can readily understand why Spaulding-Bakelite is demanded by discriminative radio fans and leading manufacturers.

Made in the Spaulding plant, famous for over fifty years of specially processed fibre—accorded the Spaulding limitless facilities for uncommon manufacturing—this bakelite for radio panels and tubes is likewise specially processed and especially dependable.

Beautiful, black, everlasting, high gloss finish. Drills, saws and engraves safely; will not shrink or split. Highest in dielectric strength. Supplied in standard sizes, individually packed in envelope containers—special sizes to order.

Write nearest office for descriptive circular.

Spaulding -BAKELITE



Continued from page 74
heterodyne oscillator's radiating energy through the grid coils and loop, no trouble will be experienced if the directions for adjusting the grid coil of the oscillator coupler are followed carefully. If an antenna tuner is added, the coupling between the antenna and secondary coils must be kept as loose as possible consistent with the proper signal strength. Otherwise, enough energy will be radiated to cause interference in nearby receivers.

Tests made with four of the improved sets installed in four separate rooms of an apartment disclosed the fact that with the grid coupling coils properly adjusted, no noise from the oscillator tubes in the four sets could be heard in any of the receivers and no other source of local interference was noted, either when the sets were all tuned to the same station or to different ones.

**FINAL PRIZES FOR IMPROVEMENTS IN 45,000 CYCLE
SUPER-HETERODYNE**

First prize, \$60.00—James R. Kenna, 234 Bush St., San Francisco; volume control.

Second prize, \$40.00—Chas. T. Maloney, 36 Preston St., Hartford, Conn.; protecting condenser in oscillator.

Third prize, \$20.00—D. B. McGown, Custom House, San Francisco; "A" tube in final a. f. amplifier.

**WITH THE AMATEUR
OPERATORS**

Continued from page 41

heard by amateurs from all parts of the U. S. The New Zealand amateurs use waves between 100-125 meters.

The number of stations using 75-80 meters is increasing rapidly and interference on this band of waves is getting worse.

7BJ of Vancouver, Wash., has moved to Portland, where he is employed as a teacher in the "Y" radio school. Amateurs and B. C. L. S.s around Tacoma, Wash., report severe Q. R. M. from the smoke precipitating plant. Assistant Radio Inspector Hayes of the seventh district held operators' exams in Boise recently. 7LO succeeded in passing the first grade commercial exams.

7AJY and 7RY each worked Porto Rico recently. Neither station used over 15 watts. The wavelengths used were between 75-80 meters.

7AFO was one of the fortunate stations to work the Shenandoah, on her recent trip to the west coast. 76R also handled some of the Shenandoahs traffic. 7ADQ was heard in France. 7DF was reported in England several times recently.

Transcontinental tests on 20 meters and 40 meters are creating a great deal of interest in amateur circles.

3CHG, Elmer Gabel, Kennett Square, Pa., has worked Z4AA, Z4AG, Z2AC, Z2AP, A3BQ, and stations in France, England, Porto Rico, Mexico and Canada on 80 meters with an input of 450 watts into a UV-204 tube.

Beat These Wet "B" Batteries If You Can

Rabat Junior (12 cells 24 volts) capacity 800 mil-amps, only \$3.96; Rabat Senior (2800 mil-amps), \$9.60. Prices F.O.B. Cleveland, Ohio. If your dealer cannot supply you, send direct.

The Radio Rabat Company

814 Bangor Bldg. Cleveland, Ohio

See the New! - - -
**MONTROSE LOW LOSS
CONDENSER \$2.50**

A new efficient condenser at a new low price. 23 plate, cap. .0005.

UNITED RADIO LABS. of the Montrose Mfg. Co.
1333 Fulton St., Brooklyn, N. Y.

**The SATURN
Perfect Jack and Automatic Plug.**

Your order filled by mail promptly
Every article absolutely guaranteed
The SATURN Mfg. & Sales Co., Inc.
48 Beckman
Street, New
York, N. Y.
Dept. B
Write for
Literature



Famous for Quality and Service

AMPLITRON TUBES

Bonded to Give Service—List Price \$4

Send in your old and burnt out Tubes—We will send you new AMPLITRON—any model—at \$2.50

Dealers and Jobbers—Write for Discount
PENNANT RADIO LABORATORIES
Dept. 23 Central Ave., Newark, N. J.



Any Condenser can be called LOW LOSS, but Only It's Performance Qualifies the Name

IN THE NEW YORK GROUNDED ROTOR scientific designing, together with the highest grade of materials and instrument workmanship combine to produce a condenser that is in a class by itself---no other condenser manufactured incorporates so many *actual improvements*.

.005 (23 plate) without Vernier **\$4.50**

Geared Vernier attachment, complete, \$1.50

OUR STANDARD NON-GROUNDED CONDENSERS are made in four sizes with or without vernier — are universally recognized for their efficiency, workmanship and low price—made possible by large production.

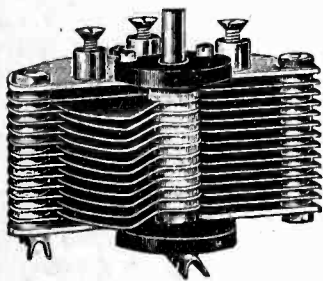
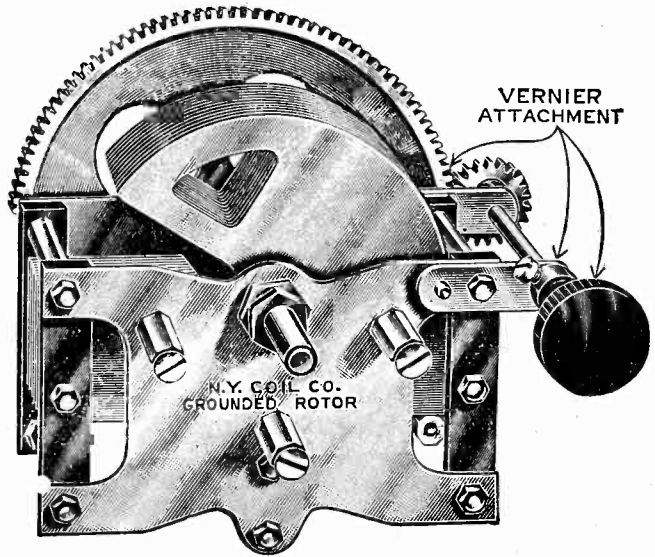

Price with Vernier Knob and Dial, 23 Plate, \$3.50. Without Vernier, 17 Plate, \$1.80. 23 Plate, \$2.00. 43 Plate \$3.00



New York Distortionless Audio Amplifying Transformers are the standard by which others are judged. 4¼ to 1 ratio correct for all style tubes. Price, \$4.00

Tuned Radio Frequency Transformers, with 17 Plate Condenser attached.....\$4.50

BY PASS CONDENSERS	
.05	\$.90
.01	1.25

NEW YORK PRECISION MICA FIXED CONDENSERS

"More Uniform Capacity"

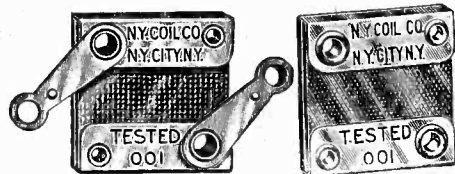

Type B Type A—No Clips

Adapted by Leading Heterodyne Manufacturers on account of truthful capacity rating. This is the only laboratory precision-built condenser on the market, yet sold at a commercial price. It is standard equipment with some of the largest and most discriminating set manufacturers.

Guaranteed for capacity and against leakage or breakdown.

The following sizes always in stock:

Capacity	Mfd.	Retail Price
.000135
.0001535
.0002535
.000535
.00140
.00240
.00560
.00675
.00025, with Grid Leak Mounting attached, 45c list.		Type C

NEW YORK COIL COMPANY

338 Pearl Street, New York City, N. Y.

Pacific Coast---MARSHANK SALES CO., 1240 S. Main St., Los Angeles, Calif.

SEND FOR BOOKLET

MAIL coupon below for our catalog and booklet, "Some Insulation Stickers Explained."

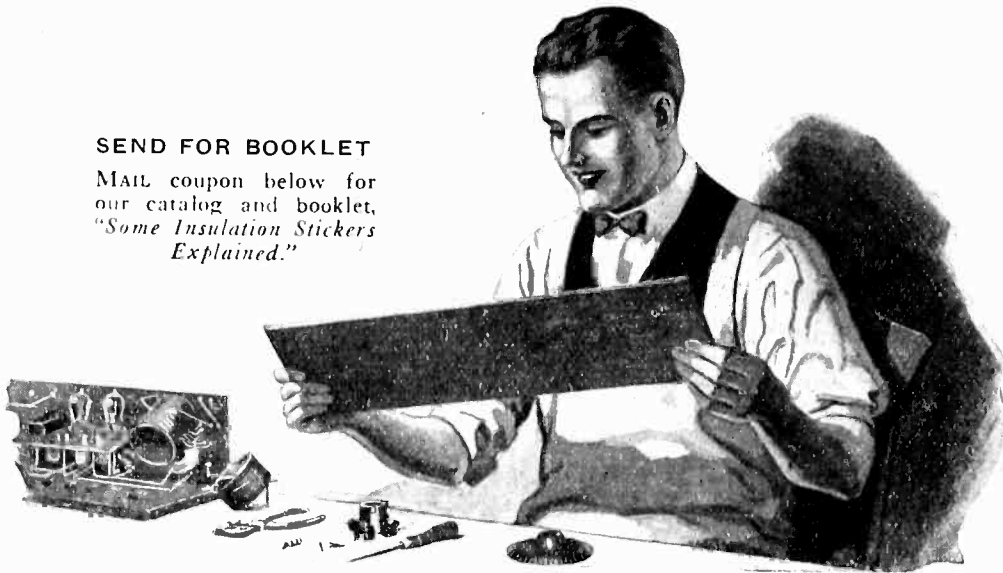

Engineers developed this special panel material for Radio ONLY.

THE radio amateur is to be thanked for the development of "the supreme insulation." When he made known his demands for DX, and for volume, it was soon evident that ordinary insulation good enough for a hundred other uses was not good enough for radio.

So we put engineers to work to develop a super panel material that would not only give ample proof of lowest electrical losses, but would also be easy to drill, saw and cut; non-warping, and good-looking to boot.

Radion was the result. There is nothing quite like it for real results.

Authoritative laboratory tests conclusively prove highest insulation characteristics. In the set you build, it may give you just that extra energy needed to tune in a distant station. When you see Radion in a ready-

built set, it is usually an evidence of genuine good quality.

You can see the difference between Radion and common panel materials, if you will look at the finish. Radion has a high, polished finish. That keeps out dirt and moisture, which, even in little particles on the surface, cause short circuits and reduce good reception.

Everyone knows Radion is the easiest panel material to cut and saw. There are eighteen stock sizes, two kinds, Black and Mahog-

anite. Sold universally by dealers who know radio. Better performance will make it worth your while to ask for it by name and to look for the name on the envelope, and the stamp on the panel.

Radion dials to match, also sockets, binding post panels, insulators, knobs, and the new Radion built-in horn.

Independent Engineers Tests of Radion prove:	
1. Lowest Phase Angle Difference.....	0.5 to 0.6
2. Lowest Dielectric Constant	3.9
3. Highest Resistivity (Megohms-om.)	1.0 x 10 ⁸
4. Lowest Power Loss Factor	0.665% to 0.875%
5. Lowest Absorption of Moisture in Air.....	.005% to .02%
6. Lowest Absorption of Moisture in Water.....	.08% to .11%

AMERICAN HARD RUBBER CO.

11 Mercer Street

New York City

Chicago Office: Conway Building

Pacific Coast Agent: Goodyear Rubber Company, San Francisco, Portland

RADION

The Supreme Insulation

PANELS

Dials, Sockets, Binding Posts, Panels, Etc.

RS-1

AMERICAN HARD RUBBER CO.,
11 Mercer St., New York

Please send me your catalog and booklet, "Some Insulation Stickers Explained."

Name.....

Address.....

City..... State.....

RECEIVER CONSTRUCTION

Continued from page 19

ably necessary to have an antenna and ground connected to the set in order to get sufficient signal strength to be audible with the radio frequency tube unlighted. Once found, the point of balance need never be changed throughout the life of the radio frequency tube, and if the dimensions and values given are followed, this setting will be sufficient for all waves to which the set is capable of tuning. Also, the regeneration coil will be found to be practically constant in its setting regardless of wave length, one setting being sufficient unless it is desired to change volume.

All tuning can be done with the two condensers alone, and with the size loop and tapped coil given, their settings will be practically uniform throughout their scale, varying possibly not more than three or four degrees, when used with a large antenna or on the loop alone. Post *L* is for an antenna of any length, while post *S* is for use with an extremely short antenna, the use of which will vary the settings of *C₂* in proportion to the length of antenna used. The same tuning chart can be used for both loop and long antenna reception.

As to the results to be expected, good reception of stations up to 150 miles should be obtained on the loop alone, maximum signal strength being obtained when the set is so placed that the plane of the loop is parallel to the direction of the transmitting station. The maximum is broad, but the minimum point, or 90 degrees from the maximum, will be found to be sharp, and in this respect the set is a self-contained radio compass. This minimum reception point can be used to eliminate interference. Reception on the loop alone is bilateral. When the loop is augmented by a short antenna of about 15 ft., connected to post *S*, the above range can be doubled, and the unilateral effect can be observed by revolving the set. With the conventional sized antenna connected to post *L*, with ground, transcontinental reception should not be the exception during the fall and winter months.

Soon to be given commercial announcement is a new vacuum tube whose filament is heated by resistance wire supplied with current from the 110 volt a. c. lines, instead of by d. c. from an *A* battery. It is provided with a standard Edison lamp base to give the 110 volt contacts. Separate cathode, grid and plate leads pass through the upper portion of glass bulb that houses the tube elements. The nichrome wire heating element is inserted into a thin quartz tube which is surrounded by an aluminum cathode or "filament" so that the latter is heated by conduction. The heating element is renewable. Together with some form of *B* battery eliminator the tube will function directly from the lighting circuit.

Free!

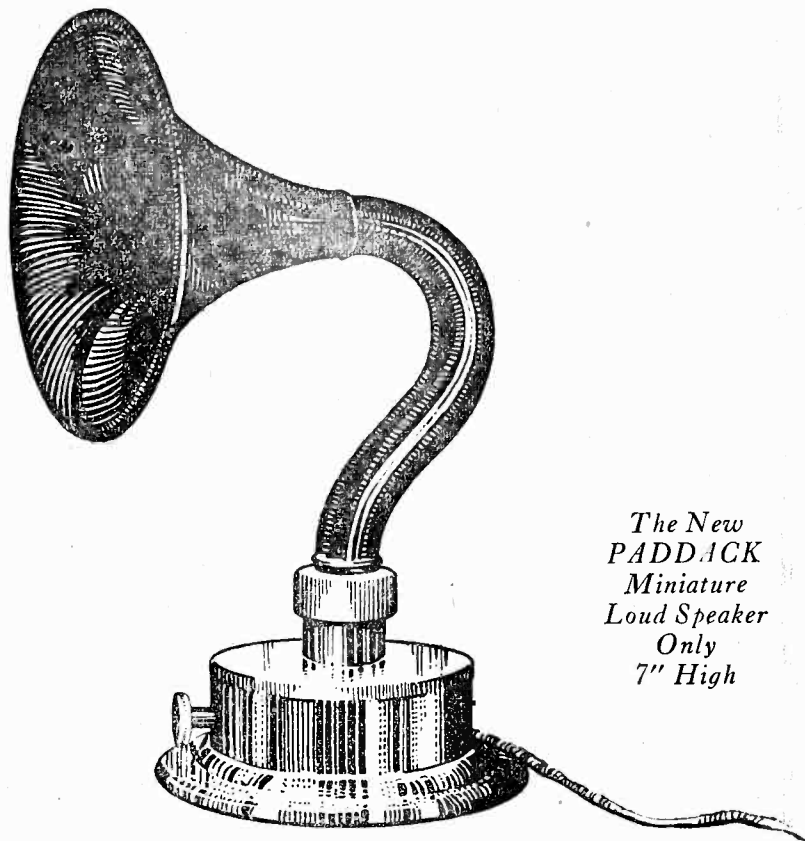

*The New
PADDACK
Miniature
Loud Speaker
Only
7" High*

A Loud Speaker For Crystal Sets

Free—this dandy little loud speaker in return for sending us your subscription to "RADIO" for only two years at \$2.50 per year. \$5.00 brings you the magazine for 24 months and the loud speaker as a premium. This sensational holiday offer positively expires on January 31st. All subscriptions must be in our hands no later than that date. Two individual subscriptions for one year each will also be accepted or you can extend your own subscription for two years more and get the loud speaker free. We guar-

antee delivery of the loud speaker without delay. Orders will be filled within twenty-four hours after your subscription reaches us. The speaker, illustrated above, is beautifully finished in brass and gunmetal. It will reproduce signals received on a crystal set. Also operated with vacuum tube receivers. Beautiful workmanship. Substantially built of best materials. Every instrument is guaranteed by the publishers of "RADIO" to give entire satisfaction. Your money refunded if you are not pleased with this premium.

We prepay the delivery charges.
Simply mail the coupon and \$5.00—right now.

This coupon must be in our hands no later than January 31st. Only a very few of these premiums available. Act now and be assured of getting one!

"RADIO," Pacific Building, San Francisco, Calif.:

Here's my \$5.00. Send me "RADIO" for two years and immediately ship to me one PADDACK loud speaker. It is fully understood that \$5.00 covers the entire charges of this great offer.

Name.....

Address.....

Have You Heard THE RADIO SHACK New Shacton Low Loss 3 Circuit Receiver?



Send for our Catalog

The
Supreme Achievement
with
VISIDIALS

A SLIGHT turn of the Visidial, then—music, lectures and entertainment of all sorts from all parts of the country. These long, cold winter evenings hold many a surprise for the owners of the new "SHACTON."

For design, construction, performance and ease of operation the SHACTON is the most remarkable achievement in present day radio. The most important feature and without a doubt the cause of SHACTON'S success lies in the fact that Low Loss instruments of the highest grade are used throughout the entire circuit. Equipped with VISIDIALS—dials behind the panel, enabling fine, sharp tuning without vernier. The Visidial adds to the appearance and improves the performance to a surprising extent. Something new, something better.

PRICE
\$29³⁹

STANDARD PARTS with VISIDIALS

- 1 7x18 Drilled Radion Mahogany Panel, Engraved in Gold.
- 1 Brunswick Low Loss 3-Circuit Tuning Coll.
- 1 Genuine Brunswick Low Loss Condenser.
- 1 Brunswick Triploid Mounting Socket and Binding Post Strip.
- 2 Brunswick Cast Foundation Brackets.
- 2 Brunswick Jacks with Gold-Plated Fronts: 1 for phones, 1 for Loud Speaker.
- 1 Freshman Mica Grid Condenser.
- 1 Standard Glass-Enclosed Grid Leak.
- 2 30-Ohm Shacton Bakelite Rheostats with Gold-Plated Indicators.
- 2 Molded Mahogany Dials grained to match panel.
- 5 Lengths Professional Bus-Bar.
- 1 Special Blue Print for this circuit. Not an ordinary hook-up but a clear picture form that a child can understand and make.
- 2 Premier Hegehog Transformers.

ALL ASSEMBLED READY TO WIRE

THE RADIO SHACK
55 Vesey Street, New York City

ACCESSORIES

Everything needed to operate after building is listed here—

- 3 Type 201A Tested Tubes \$10.35
- 1 60-Ampere Hour Storage Battery 11.25
- 2 45-Volt Extra Large Enco "B" Batteries 6.50
- 1 Pr. 3000-Ohm Head Phones and Cord 3.75
- 1 Antenna Equipment 1.50
- 1 Phone Plug, Double70
- COMPLETE OUTFIT** **\$34.05**

Parts also sold separately

CABINET FREE

Order Set and Accessory Outfit both together, and we will send Fine Mahogany Finish Cabinet FREE!

MAIL COUPON TODAY

THE RADIO SHACK, Dept. A-33
55 Vesey St., New York, N. Y.

Please send me the "Shacton" outfit I have marked. When it arrives I will pay the postman the amount. If I am not satisfied I will return it in 5 days, and you agree to refund my money instantly. Mark choice in square.

- (A) Complete Building Kit... \$29.39
- (B) Operating Outfit \$34.05

Name

Address

City State

REACTANCE COUPLING

Continued from page 25

battery, distortion may be obtained due to the curvature of the tube characteristic.

In concluding this article, a slight modification of the circuit in Fig. 1 will be given which will enable better quality to be secured. It will be observed that the loud speaker is placed directly in the plate circuit of the last tube. This is the usual manner of connecting a loud speaker. It may result in distortions because the direct current of the plate circuit may saturate the iron core of the loud speaker. Another disadvantage is that if the plate current flows through the magnet windings in the wrong direction the loud speaker may gradually lose its magnetism and so become less efficient.

To avoid these effects of the direct current flowing in the plate of the tube the circuit shown in Fig. 2 may be employed. Another plate reactance equal to those in the preceding stages is used in the plate circuit, and thus maximum undistorted amplification is obtained across it. The direct current of the tube thus flows through this reactor. The loud speaker is coupled to this reactor through a 1 or 2 mfd. condenser and the audio frequency voltage across the plate reactor is made to op-

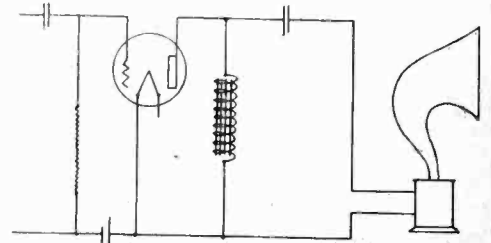

Fig. 2. Alternative Connection for Loud Speaker.

erate the loud speaker. Thus the direct current is excluded from the loud speaker.

Any number of stages up to three may be employed, depending upon the type of receiver employed. Such an amplifier will give just as good quality as any resistance coupled amplifier, is more efficient from an amplifying point of view in that it utilizes the amplifying properties of the tube up to its maximum capacity, and at the same time is more economical in B battery. For those who are seeking a high quality amplifier this system should commend itself.

"INSULATE"

(Molded Composition)

AND

"HI-HEET"

(Bakelite)

Articles of Any Shape
Molded to Order

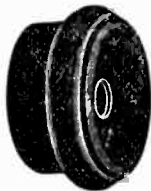

100 STYLES
Knobs, Dials,
Binding Posts,
Head Caps,
Insulators, etc.
In stock for prompt shipment



Insist on
"Hi Heet" or
"Insulate"
from your
dealer.

GENERAL INSULATE CO.

999 Atlantic Ave., Brooklyn, N. Y.

"Elements of Radio Communication"

By Lieut. E. W. Stone

\$2.50 A Book that
every radio fan
should have.

SENT POSTPAID ANYWHERE
PACIFIC RADIO PUB. CO.
Pacific Bldg., San Francisco

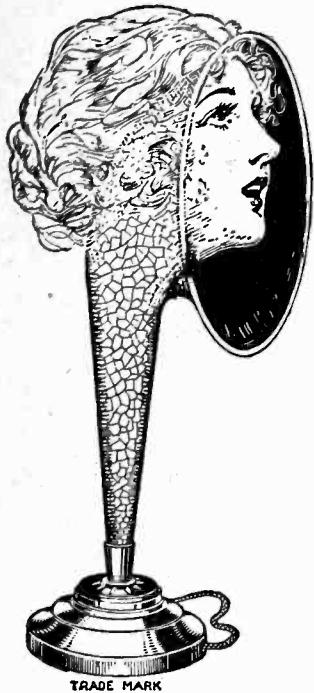

TRADE MARK

Atlas

TRADE MARK

RADIO REPRODUCTION Speaker

ATLAS floods the room with the best that's in your set. Write for interesting literature you ought to read before buying ANY speaker.

Multiple Electric
Products Co., Inc.

365 Ogden St., Newark, N. J.,
Dept. W.

New York, Boston, Philadel-
phia, Baltimore, Pittsburgh,
Detroit, Chicago, St. Louis,
Rialto Bldg., San Francisco.

Marconi Wireless Telegraph Co. of Canada, Ltd.
Sole Canadian Distributors

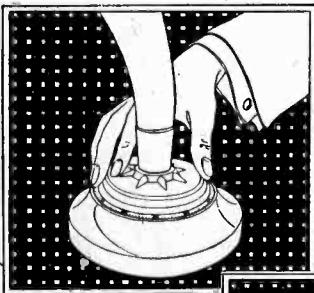

A slight turn of the ex-
clusive Atlas harmonizer
(Pat. applied for) — and
your speaker is harmo-
nized with the broadcast
you are hearing and the
set you are using. It
gives you radio—as you
ought to hear it.

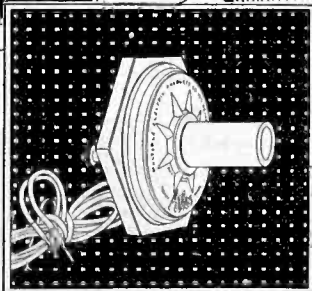

Atlas unit, with at-
tachment couplings
to fit all standard
phonographs.

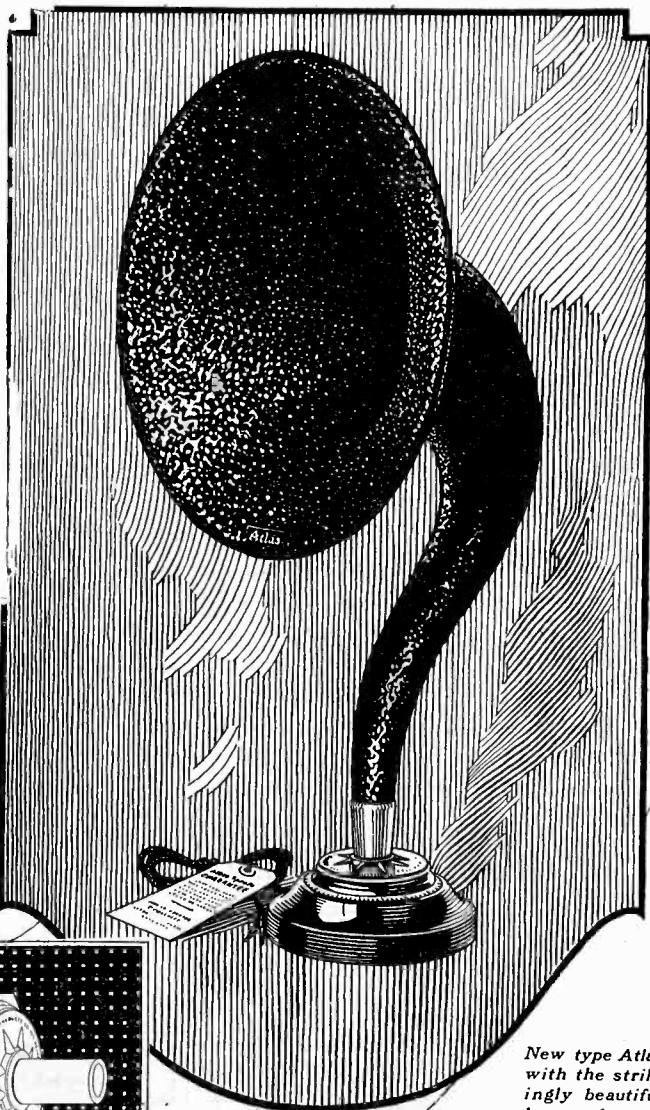

New type Atlas
with the strik-
ingly beautiful
bronze-brown
ripple-finish
gooseneck horn.

Tell them that you saw it in RADIO



Simplicity Wins!

EELIMINATE the complicated assemblies of condensers, variometers, couplers and frequency transformers! Forget the worries of balancing and neutralizing this maze of instruments.

The *DeRoy Phusiformer* takes their place and does the work more efficiently. Build any number of different circuits with the same *DeRoy Phusiformers* without discarding one single part. Increase your range and volume from one to six times as you wish, simply by adding *DeRoy Phusiformers*. No complicated wiring, no muss, no fuss! Sets built this way do NOT howl, whistle, squeal or distort the programs in the slightest. Absolutely tone-pure reception!

Price with Dial **\$9.00**
Each

If your dealer does not as yet handle DeRoy Phusiformer, send money order for required amount of units.

DeROY RADIO CORP.
281 Plane Street, Newark, N. J.

See Page 115 for BARGAINS

"Built First- **Coto** -to Last"

INSIST ON THE SILVER PLATED AIR CONDENSER FOR YOUR RADIO SET.

"COMO DUPLEX"

The World's Standard Push-Pull Transformer. \$12.50 per pair. Send for descriptive literature. COMO Apparatus Corp., 146 Tremont St., Boston, Mass. Washington and Oregon Representative
C. E. GAY
100 Lowndale St., Portland, Oregon

OPERATOR'S LICENSE

Continued from page 34

stuff is sure of passing the test in the radio inspector's offices.

While the automatic sending machine can often be used to advantage, it should be remembered that variety is essential to the student's practice. One quickly becomes familiar with the wording of the disk and it is then of no value. An excellent way of using these disks after they become known is to reverse them. Then when the machine is operated the words are not only heard backwards but many of the letters are changed. This material, as it doesn't make sense, will not prove as easily memorized as the straight messages. When a receiving speed of ten or twelve words a minute is reached the machine can be laid aside and the phones assumed permanently.

The student who has no means of charging a storage battery for his audion filament should know of the Edison primary cells. Eight of these type Q, will be sufficient as on a closed circuit they each deliver about .7 volt. The rheostat must be turned full off when lighting the filament as they deliver a higher voltage on open circuit and a burned out filament will result from the neglect of this precaution. There will then be a few moment's adjustment necessary until the batteries become steady they can then be relied upon to stick by you as long as you care to stay at the key or phones. A small double-pole, double-throw switch will provide a handy means of changing over if you employ them for both sending and receiving.

Try to be on the air, one way or the other, as much as possible. No sending machine will take the place of the knowledge gained on the air, one must hear the jam of interference, find ways of circumventing static, and learn the accepted ways of handling commercial traffic in order to be of any use at a station after gaining one's license.

Radio transmission of photographs across the Atlantic was successfully accomplished by the engineers of the Radio Corporation of America on Nov. 30th. The equipment was developed by C. H. Taylor, E. W. F. Alexander and R. H. Ranger. The photoradiogram device operates as an accessory to the regular trans-oceanic transmitters. It is expected that refinements will considerably reduce the time of twenty minutes now necessary to send a picture. The picture is received in the form of thousands of dots placed in parallel lines, thus resembling a coarse screen halftone.



Build your own set at half the cost

ENJOY the pleasure of building your own set; at the same time save half the cost. Now Shamrock, through quantity production, is able to offer you a complete kit at half the usual price.

The Shamrock kit contains all parts necessary to build the marvelous Shamrock-Harkness Two Tube Reflex—the sensation of the radio industry.

It combines the best features of the leading circuits; distance from the Neutrodyne, clarity from the Reflex, volume from the Regenerative.

The Shamrock Kit contains only genuine licensed Harkness parts. To insure success, avoid imitations, accept only the genuine.

Features

Operates a loud speaker.
Two Tubes do the work of five.
Cuts battery costs 60%.
Does not squeal, howl or radiate.
Stations can be logged.
Amazing clarity and volume.

SHAMROCK MANUFACTURING CO.
Dept. 58, Market Street, Newark, N. J.

Price **\$35**
Kit Complete



Licensed under U. S. Patent Office Serial No. 719,264 for Radio-Receiver Systems.

Send 10c for "Shamrock Radio Builders' Guide Book"

SHAMROCK

FOR SELECTIVE TUNING

SHAMROCK MANUFACTURING CO.
Dept. 58, Market St., Newark, N. J.
I enclose 10 cents (U. S. stamps or coin) for copy of "Shamrock Radio Builders' Guide Book," containing diagrams and complete instructions for building 10 sets at prices ranging from \$15 to \$50.

Name.....
Address.....
Dealer's Name.....



Four Way Company
Springfield, Mass.

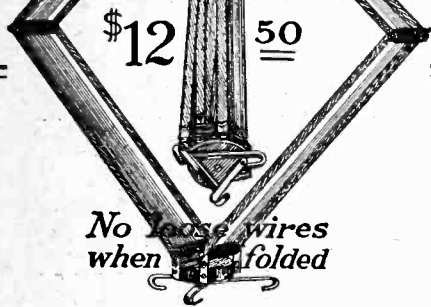

No loose wires
when folded

QUALITY LOOP

The only folding loop on which wires stay taut when opening and closing. Wires CAN'T get tangled!

Simplest, Most Positive
Single Radio Plug



Price 50c.

The Spring Terminal used in the Single Plug and the Four Way Plug (shown below) is without doubt the surest and best connection, as the tips are gripped all around, insuring a perfect connection with no lost energy.

No tools are needed. Just insert tips by pressing and turning to the right. Fits all standard Jacks; takes all types of tips.

The New Four Way Switch Plug

Is a multiple plug used to connect the head phones and loud speaker to the radio set.

The dial at the base of the plug stem revolves with stops in four positions.

No tools needed. No set screws to get lost. Fits all standard Jacks. Takes all types of tips.



The Extension



Cord
Jack

Price \$1.00
is manufactured under Patent 1,490,003 to use the loud speaker or phones in other parts of the house without moving set.

No tools or soldering iron needed to make connection.

Takes any standard plug.
Price \$1.00

Manufactured by

Four Way Company
Myrick Bldg. Springfield, Mass.

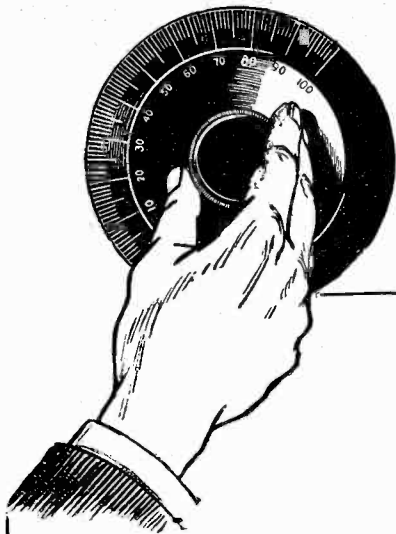

One Dial

But one dial to tune, no unsightly outside Antenna, no Ground to bother with. It's easy to get Volume, Distance and Selectivity with the

MODERN Super Six "REFLEX"

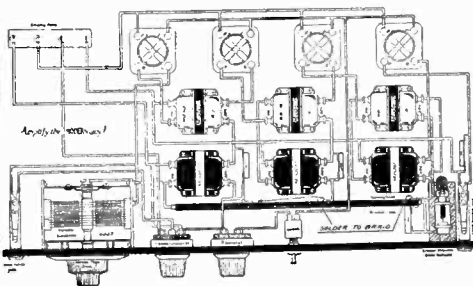

This set is easy to build and your friends will marvel at the results. Full size wiring diagram and complete constructional bulletin of above circuit sent on receipt of 4c in stamps. Write for it today.

MODERN engineers have steadfastly refused to cheapen their product to meet the requirements of some set manufacturers. When you buy MODERNS in a set, you'll know price was not the consideration for the manufacturer's choice of MODERN Transformers.

The Modern Electric Mfg. Co.
TOLEDO, OHIO

World's largest
transformer
manufacturers
making
transformers
exclusively for
Radio purposes



Why not subscribe to
"RADIO" for 6 months?

Price, \$1.00.

"-- truly remarkable!"

The National Regenerator

for the Browning-Drake circuit. A 4-tube set that's a wonder. Send for Bulletin 105R

NATIONAL COMPANY

110 Brookline St., Cambridge, Mass.

Tell them that you saw it in RADIO

Tested and Listed as Standard by Underwriters' Laboratories

U. S.
Patent
1,495,682



A noiseless, bulbless battery charger for the Pacific Coast

The Balkite Battery Charger is today universally accepted as one of the most efficient and trouble-free methods of charging radio batteries.

It is entirely noiseless, has no moving parts, vibrators or bulbs, and nothing to adjust, break or get out of order. It cannot discharge, short circuit or damage the battery by overcharging. It needs no attention other than an occasional filling with distilled water. It is unaffected by temperature and fluctuations in line current. It is simple, efficient, and unfailing in operation. It can be used while the set is in operation. Its operation does not create disturbances in your set or your neighbor's.

Charges the 6-volt "A" battery at 3 amperes, from 110-120 AC, 60 cycle current. Special model for 50 cycle. Will also charge "B" batteries of the lead type. If your dealer cannot supply you, sent direct prepaid on receipt of price.

FANSTEEL PRODUCTS COMPANY
North Chicago, Ill.

PACIFIC COAST DISTRIBUTORS: San Francisco: A. S. Lindstrom, 111 New Montgomery St.; Los Angeles: Lombard J. Smith, 151 E. 34 St.; Seattle: George H. Malre, 95 Connecticut St.; Portland: H. A. Killam, 140 1/2 North Tenth St.

Price \$20

FANSTEEL East of Rockies \$19.50 In Canada \$27.50
Balkite
Battery Charger

Greater Distance—Less Noise

TURN-IT
ADJUSTABLE
GRID LEAK

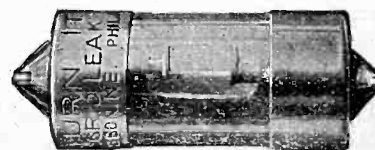

Only \$1 at Your Dealer's or Direct From Us.
TURN-IT RADIO SALES, Inc.
71 Murray St., N. Y.

New Adventures of BURGESS RADIO BATTERIES



(Above)—They Roamed the World In the Speer's Radio Room—U.S. Navy photo
(Below)—Dog Sleds Carry Them to the Arctic Outposts of Civilization

You're fortunate—you average buyer of radio equipment. For when you are in need of new batteries you can phone or walk a few blocks for fresh ones to replace those in your receiver. Not so fortunate are those who wander across the world or spend their lives in the lonely outposts on the frontiers of civilization.

To them the correct selection of dependable receiving equipment is vital. For to be deprived of the use of their radio set is a dire catastrophe, and results in complete isolation from the world outside.

Those who must receive absolute, unflinching service over longer periods always buy Burgess "A," "B" and "C" Radio Batteries.

"Ask Any Radio Engineer"

BURGESS BATTERY COMPANY
Engineers DRY BATTERIES Manufacturers
Flashlight - Radio - Ignition - Telephone
General Sales Office: Harris Trust Bldg., Chicago
Laboratories and Works:
Madison, Wis.
In Canada:
Niagara Falls and Winnipeg



INTERFERENCE ELIMINATOR

Continued from page 26

Fig. 4 shows one of the methods of multiple reception using but one antenna. Preceding each receiver and coupling it to the antenna, is a single tube which acts as a radio frequency amplifier and

ing four sections (all painted) and a man at each guy playing out, sections 1, 2 and 3 were raised skyward until the bottom rested on the scaffold platform. A 10 ft. section was dropped in the crock below, fastened temporarily rigid at the top to the scaffold, and the bot-

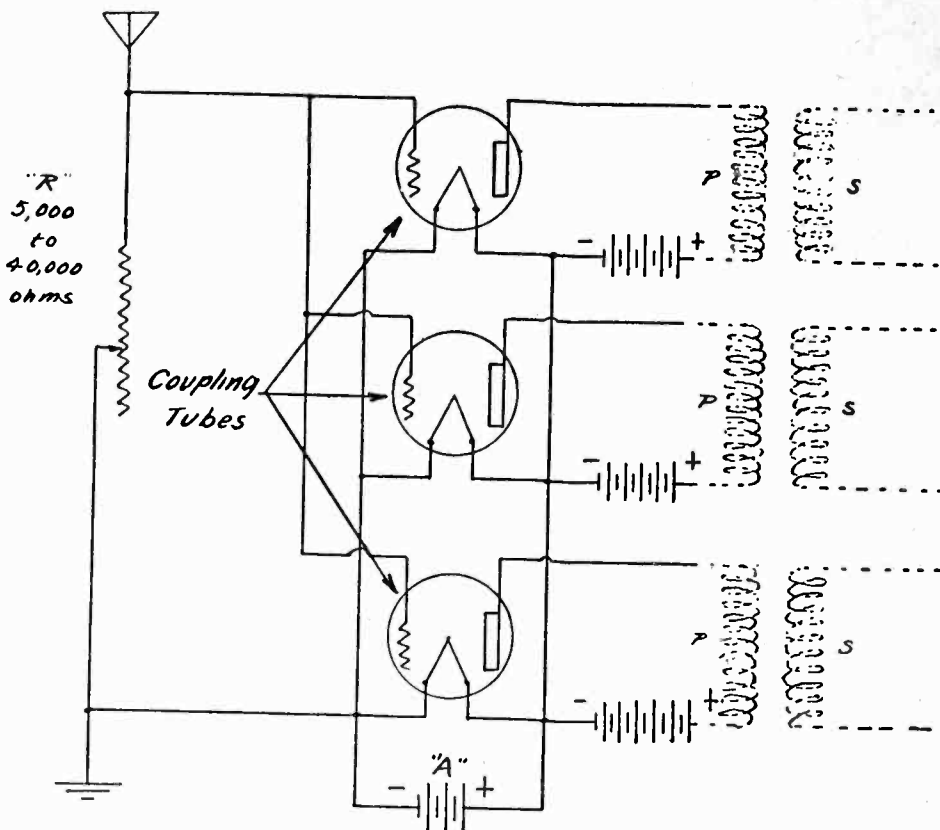

Fig. 4. Method of Coupling Several Receivers to One Antenna

coupler, permitting the transfer of energy in one direction only namely from the antenna to the receiver. Therefore the primaries tune absolutely independent of each other and there is no more difficulty in connecting an indefinite number of receivers to one antenna than in using one receiver.

The coupling or radio frequency amplifying tubes, once turned on, require no more adjustment and each operator handles his own receiver as if he had an independent antenna.

Note: The primary tuning is a little less sharp in this arrangement. This arrangement has shown to have several advantages—as using but one antenna, also greatly reduces the feedback or heterodyne action in CW work between receivers, which is causing so much interference lately.

FEATHERWEIGHT MAST

Continued from page 32

ft. was then given two coats of heavy asphaltum paint, as were the remaining four sections.

The foundation consists of a large rock buried 2 ft. in the ground, upon which rests on end a 4-in. inside diameter sewer crock protruding a foot or so above the ground. A scaffold some 8 ft. high was built around the crock and the 30-ft. section stepped. By having within reach of the scaffold the remain-

tom of section 3 dropped over section 4. Section 4 was lifted and dropped pile-driver fashion in the crock until it telescoped a foot into No. 3, (gravity doing the work). Sections 1, 2, 3 and 4 were raised and section 5 stepped in crock, etc. At the intersection of sections 4 and 5 at the scaffold level another set of guys were soldered loop fashion, making three sets in all.

Within an hour after stepping the original 30 ft., we had a rigid 3-in. tube poking its head some 65 ft. above the ground. I feel safe in saying that if we had more pipe at hand we could have gone 100 ft., or better in this manner without mishap. One man can easily lift the entire mast if the guys are played out tactfully as he lifts. It is not necessary to solder the individual section joints if the lower ends are placed over the upper. The base was then cemented into the crock, the whole being water tight.

I might add that a flexible galvanized iron wire halyard is recommended, and one should use care in applying the acid when soldering. Do not drill the pipe at any point. 8FT had a 60-ft. mast of the same material break and fall while trying to reinforce the joints with bolts. This is not necessary. My mast has withstood some pretty severe winds and indications are that it will last a lifetime.

APEX VERNIER DIAL



It Brings 'Em In!

Get more stations—greater range—bigger volume—finer and crisper—less interference. Leads faster. The one big advance yet made in tuning. Ratio 12 to 1. Quality applied to any cast. For sale by all good Radio Dealers. If unable to obtain from dealer, enclose \$2.50 for nickel-silver finish, or \$3.50 for De Luxe satin finished gold.



7-Tube Super-Heterodyne for \$97.50

Receive the parts complete to assemble your own set. (Circuit as usual on a 7-11) Loop. Assemble this 7-tube super-heterodyne on a 7 1/2 in. panel in three hours. Parts complete, including drilled and engraved panels, condenser, sockets, transformers, dial connecting plugs, cables, etc., with drawings, diagrams and instructions. Free of cabinet—no on application. (If your radio dealer cannot supply parts for complete wiring Radio Kit, send check or money order for \$77.50 and name of your dealer.)

APEX ELECTRIC MFG. CO., Dept. 141
1410 W. 59th Street, CHICAGO

MOLDABLE INSULATING MATERIAL

Continued from page 30

undercuts, and then will spring back into shape. Cut a proper pour-hole for the plaster and it is ready for the cast.

After use the mold can be laid away for future re-use, as it will keep perfectly.

With solid molds, one can introduce into the finished article metal parts such as contact pieces. These are to be so fitted to the mold that they will come away with the plaster. This process can not be so well done with the flexible molds, though it is possible.

Whatever type of mold is prepared, the casting process is the same. Mix the plaster with water in such proportions that the liquid will be of the consistency of thick cream. Pour it into the mold and let it stand an hour. Remove it from the mold with care, for it is still moist and much more fragile than it will be when dry. Let it dry at natural temperature, though standing in the sun will do no harm, and free circulation of the air will hasten the process. When well dried, say after six hours for a casting the size of a variometer shell, melt the Brazilian wax over a gentle heat and immerse the plaster cast. Keep it in the melted wax till no more bubbles appear. Then remove it and let it cool, and it is done.

It will be found that the insulation resistance of the finished and saturated cast is high, and this seems somewhat surprising when one considers what a large amount of water makes it up. But much of the water enters into chemical combination with the plaster, and is not free moisture any longer. Further, what free water was left after the cast was dried has now been driven off in the wax immersion. Still further, the place of the free water has been taken by the wax, so that there is no space for moisture to occupy and no tendency for the cast to take up any by capillary attraction, as it would readily do except for the wax treatment.

Standardization, both as to nomenclature and apparatus; the general use of "frequency" rather than wavelength; the reduction of interference from broadcast and ship stations, and the elimination of fraud in advertising, were features of the recent round table discussion and conference of the Radio Section of the Associated Manufacturers of Electrical Supplies at New York. Controls also came in for discussion, and it was agreed that they should turn clockwise, 0 to 100. The elimination of misleading advertising of radio apparatus and supplies was the subject of a report from the National Vigilance Committee of the Associated Advertising Clubs of the World. Measures of a combative campaign to accomplish this purpose were outlined by the committee.

Tell them that you saw it in RADIO



and now - Forget Wavelengths

In the Arabian Nights story, the words "Open Sesame" magically—instantly—opened the door. The ULTRA-VERNIER Tuning Control is the "Open Sesame" to any station once difficult to find or stumbled upon.

Simply pencil-mark any station on this cleverly contrived, beautifully silvered dial. Then forget its wavelength—turn the finder to your mark and, without awaiting the announcer, know you hear this set station.

Moreover, the ULTRA-VERNIER is a single vernier tuning control. Replace your old dials with ULTRA-VERNIER Tuning Controls—today!

1. This alignment is the gauge for penciled station records.
2. Operates vernier for hair-splitting adjustment.
3. Takes standard condenser shaft lengths—easy to mount.
4. Penciled station records easily erased from silvered dial.



Designed by R. E. Lacault, E. E. A.M. I.R.E., inventor of the famous Ultradyne circuit. This monogram seal (R.E.L.) is your assurance of Lacault design.

Made by the Hammarlund Mfg. Co. your assurance of quality and dependability—produced solely for the Phenix Radio Corporation. At your dealer; otherwise send purchase price and you will be supplied postpaid.

\$2.50

Write for descriptive circular

ULTRA-VERNIER TUNING CONTROL

PHENIX RADIO CORPORATION
9 Beekman Street
New York City

Save 25% to 50% On Everything in Radio

Standard Sets, all types, \$5.00 to \$79.00. Knocked down, sealed kits. All accessories. 150,000 customers. Money back guarantee. Immediate delivery. Illus. catalog on request. Special prop. to community agents to get into radio business. Radio Dept. 126 IMPERIAL LABORATORIES, Coca Cola Bldg., Kansas City, Mo.

\$1.00 Brings You "RADIO" for Six Months. Subscribe Right Now!



ANT, SPEAKER +, SPEAKER -, A BAT +, A BAT -, B BAT +, B BAT -, C BAT +, C BAT -, B AMP +, B DET +, GND, LONG ANT, SHORT ANT, LOOP, PHONE, INPUT

Tops Don't Come Off. 25 Different Markings. Scientifically Made. Beautifully Finished.

Insist on and get Genuine EBY Binding Posts

H. H. EBY MFG. CO. Phila., Pa.

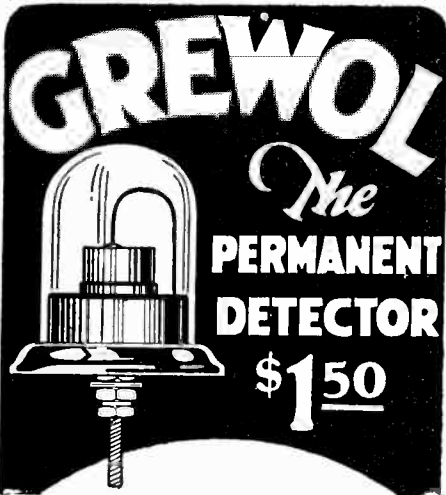

Reflex Crystal

Insures greater distance, selectivity, sensitiveness. Replace your present crystal with the Grewol Fixed Detector. All you need to improve your set.

If your dealer does not carry the Grewol detector, mail your order direct (mentioning your dealer's name.)

Patented May 15, 1923.
Serial No. 1454997.

Infringement subject to prosecution

GREWOL 2 in 1 CRYSTAL

Two surfaces instead of one; double life; double value.

50c.
Each



Jobbers! Write for Exclusive Territory Proposition

GUARANTEED BY

GREWOL MFG. CO.
NEWARK, N. J.

The UTAH Loud Speaker

Made in Salt Lake City

At last, a loud speaker so superior that it is sold on a positive two weeks' money-back guarantee of satisfaction. Ask your dealer!

UTAH RADIO PRODUCTS CO.
1427 Michigan Ave., Chicago

Write for complete illustrated FREE Catalog of

PARAGON

Reg. U. S. Pat. Off.
RADIO PRODUCTS
ADAMS-MORGAN CO., 2 Alvin Pl.,
Upper Montclair, N. J.

Pacific Coast Representative:
PAUL SUTCLIFFE,
R. 400, San Fernando Bldg., Los Angeles

RESISTANCE CONTROL

Continued from page 28

While circuits and sets developed without a knowledge or recognition of the fundamental principles of radio engineering may give startling results at times, consistent satisfactory results cannot be expected. This is due to the fact that the reasons for success or failure in any particular instance are not known even to the designer himself.

It might be of interest to digress for a moment to consider a situation resulting from the fact that no one manufacturer is in a position to commercially make or sell a receiving set which is designed on the basis of the best scientific knowledge available today. This is due to the fact that since this scientific knowledge is controlled by a large number of patents owned by many interests it is impossible from a practical standpoint for any one concern to obtain licenses under all of them. The manufacturer must therefore purchase licenses under certain patents and then endeavor to avoid the infringements of others.

A competent radio engineer can build a receiving set fundamentally better than any now on the market, but he cannot sell it. Those who are not competent engineers, however, would do best to purchase the best set available unless they wish to undergo an intensive course of training in the fundamentals of radio communication before making their own. This is not intended to discourage those who desire to experiment in the construction and operation of radio receiving or transmitting sets, but rather to instill in them a wholesome respect for the fundamentals of high frequency engineering and to enable them to judge when they see the title "Radio Engineer" whether or not that title was earned by years of study or merely assumed on the strength of a little dabbling in applied radio set building.

Secretary of the Navy Wilbur has made a number of important German radio patents, held by the government since the first part of the World War, available for American manufacturers. Applications for licenses on file will soon be signed and manufacture here begun. Among the most valuable of the radio patents is the Reflex Circuit invented by Wilhelm Schloemilch and Otto von Bruk. All the licenses will be issued as "non-exclusive, non-transferable and revocable." Agreements would continue in effect until January 1, 1933, or extended throughout life of patents. A reciprocal clause of the agreements requires for the government use of licensee patents through same period for official use only. The government's licenses do not contemplate the use of apparatus manufactured under the patents for international communication.



Make Your Loggings REALLY Count!

You don't have to play hide-and-seek with the radio-casting stations. They are on definite wave lengths. And if your set is equipped with a

PROUDFOOT

LOW LOSS VERNIER CONDENSER

once you get a station, you can log your reading—even the vernier adjustment.

Number of Plates	M. F. C.	With Vernier Dial and Knob	Without Vernier Dial and Knob
13	.00025	\$3.75	\$3.25
17	.0003	4.40	3.90
25	.0005	4.50	4.00
43	.001	5.75	5.25

4 in. polished bakelite two piece (for group and vernier readings) dial \$1.00

4 in. polished bakelite one piece (single scale) dial to match .75

Polished bakelite knob with pointer (for rheostat) to match .50

If your dealer can't supply you, write us, sending his name. Jobbers and Dealers: Write us on your letterhead for the facts. CRUVER MFG. CO., 2456 W. Jackson Blvd., Chicago III.

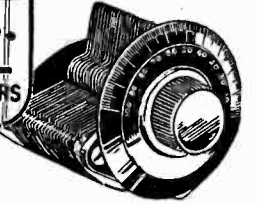

NEW HEXAGON SHAFT

Insures Condenser Perfection

Eliminates fanning; rotor blades stamped with hexagon hole are held rigidly on hexagon shaft. Found in types 3 and 4, Celeron End Plates; 5 and 6, Metal End Plates.

100% GUARANTEED
Write for literature

Coast representatives:

Radio Electric Distributing Co.,
1113 Wall St., Los Angeles, Cal.

U. S. TOOL COMPANY, INC.
114 Mechanic St. Newark, N. J.

Mfrs. of special tools, dies, jigs, automatic machinery and sub presses

De Luxe Extension Cord and Plug

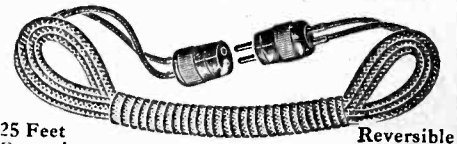

25 Feet Extension

Reversible Plug

Adapted to every make of loud speaker — phonograph attachments—head phones.

Designed with a double purpose. A radio convenience—eliminating distortion.

Made to Fit Each Other, Extending To Any Distance

Price \$2.00 Complete

WESTERN RADIO INC.
1224 Wall St., Los Angeles, Cal.
Western Distributors

POLYPLUG

Positive Contact Always Maintained

Simply slip the Polyplug into the loud speaker or head phone socket and a positive contact is maintained regardless of pulls, jerks and jars on the phone cords, assuring uninterrupted and clearer reception of programs. All unsatisfactory features of screw type plugs are eliminated. The tension slot, an exclusive feature, makes the Polyplug the most convenient and efficient plug made.

It's genuine, Bakelite, too.
At all reputable dealers.
POLYMET MFG. CORP.
70 Lafayette St.,
New York



75¢ WORTH IT

The Genuine Mastertone Radio Tubes



Durable and powerful, bring in distance with a maximum of volume of clearness.

- Type 200—5 Volts 1 Ampere Detector Tube.
- Type 201A—5 Volts .25 Ampere Amplifier and Detector.
- Type 180—3-4 Volts .06 Ampere Amplifier and Detector.
- Type 12—1½ Volts .25 Ampere Platinum Filament Amplifier and Detector.

ALL TYPES
\$2.25 Each

ALL TUBES GUARANTEED TO WORK in radio frequency. Especially adapted for Neutrodyne, Reflex and Heterodyne Sets. SHIPPED PARCEL POST C.O.D.

Mention Type when ordering.
Dealers and Distributors Wanted.

ACME PRODUCTS COMPANY
903A Broad St. Newark, N. J.

Radio World

The National Illustrated Radio Weekly

Devoted to all phases of radio. For the novice and expert, the dealer and the manufacturer. Issued every Wednesday, 15c a copy, \$6.00 a year (52 weeks), \$3.00 six mos., \$1.50 three mos.

RADIO WORLD covers the radio field in an interesting and thorough manner. It gives all the late radio news, business and technical, every seven days. It is weeks ahead of other radio publications in printing pictures and descriptive matter of important developments in the radio field. Your newsdealer can get RADIO WORLD thru his wholesaler. See every issue for latest price quotations on standard sets and parts.
Trial Sub: 8 issues for \$1.00.

RADIO WORLD, 1493 Broadway
New York City

RADIO WORLD is a great adv. medium at \$200 a page, \$7 an inch. Classified ads., 10 cts. a word, 10 words minimum.

THE "C" BATTERY

Continued from page 33

wound with No. 30 wire, proved as efficient, so far as I could tell, as the larger diameter chokes for use in isolating the rf energy in the plate circuit supply lead to the transmitter.

This C battery acted as effectually with the inductively coupled Hartley as with the direct coupled.

I don't think that a hint in regard to the Hartley circuit will be amiss here, especially as you may have or may be suffering from it. In the general representations of the circuit the plate tap is drawn at the antenna end of the helix, but you will notice in Fig. 1 that I have shown it at the opposite end. My experience has been this: The set is more often unstable with the usual connection than with the connection I show. By instability, I mean the case where the set is difficult to key, missing out on certain letters, and oscillating rather irregularly, instead of every time you press the key. This fault, of course, makes intelligible telegraphy impossible. Often, in such a case, the sole change necessary is the changing of the plate end of the coil and thereby the coupling. Where your nodal point results in your centertap appearing about half way between antenna and counterpoise, the changing of the plate tap is likely to prove a useless expedient as it will fail to change the coupling. This putting of the plate to the end of the coil opposite to the antenna generally results, in addition, to a slight diminution of the key-click, though not in its elimination of course; and a more constant position of the grid and plate taps for various wave changes. These are appreciable gains, as they simplify adjustment, among other things.

Another thing that will help simplify the adjustment of your Hartley is to do as Reinartz suggests and cut down the size of your counterpoise until it includes between it and the centertap and nodal point, the same number of helix turns as does the antenna. But this is not always convenient, or, like in my case, not at all desired. The next best thing, then, is to put a variable in series with your counterpoise, include the same number of turns between it and ground as between antenna and ground, and adjust the variable for best antenna current. After that the antenna and counterpoise, for any adjustment, will hold the same number of turns always between each, respectively and the centertap which should be grounded. You see, you never have to worry about the varying positions of the two on the helix.

See Bargains on Page 115

"Elements of Radio Communication"

By Lieut. E. W. Stone

A Book That Every Radio Fan Should Have.

\$2.50

SENT POSTPAID ANYWHERE

PACIFIC RADIO PUB. CO.
Pacific Bldg. San Francisco



Tuned Transformer Coil No. 14
Price \$2.00

SICKLES
DIAMOND WEAVE COILS
PATENTED AUGUST 21, 1923
HOLD THAT STATION!

You can get and hold the station you want, and keep out the others, with Sickles Diamond Weave Coils. Sickles Tuned Transformer Coil No. 14 and the Knockout Reflex Coil No. 8, especially designed for popular circuits, make a receiving set remarkably selective.

The No. 14 Tuned Transformer Coil is absolutely self-neutralizing when placed at the proper angle in a set.

Write for particulars.

THE F. W. SICKLES CO.,
338 Worthington St.,
Springfield, Mass.



Knockout Reflex Coil No. 8
Price \$4.00 a Pair

MARVELOUS NEW AUDIO TRANSFORMER
adds a musical quality to any set far beyond anything you ever heard before.

KARAS HARMONIK
Amplifies low, middle and high tones—all to the same big volume, thus eliminating distortion. Bring out the vital harmonics and overtones of music. Price \$7.00. Write Karas Electric Co., Dept. 59-39, 4040 N. Hollywood St., Chicago



RADIOLA III—FREE with Home Study Course

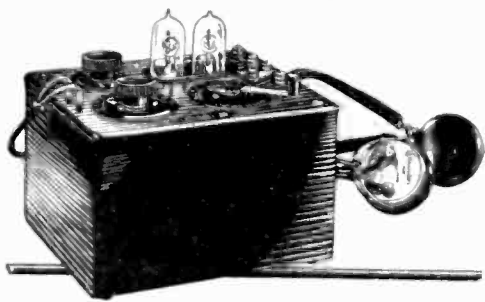

A Life Career for YOU in RADIO

Thousands have won success in radio. Right now our graduates are voyaging to foreign parts as radio operators—ships' officers—with good pay—and no expense for rations and quarters. And hundreds of them are holding high salaried positions on land.

You, too, can earn big pay—and visit strange lands—or win success in radio right in this country! A few months of interesting study, either at our San Francisco residence school or at home, on the special Home Study Course of the Radio Institute of America—and you can secure your Government Commercial Radio License—and your first radio job.

RADIOLA III—Free with Home Study Course

The Home Study Course is a new one, completely revised. New text-books. Radiola III with two tubes and Brandes headset and other exceptionally high grade apparatus free with course. Experts correct and grade your papers and answer all your questions. The most comprehensive and up-to-date radio instruction obtainable anywhere.

Don't delay. Fill out the coupon and send it today for our new booklet.

Radio Institute of America

(Formerly Marconi Institute)
Established 1909

Western District Resident School
New Call Bldg., New Montgomery St.
San Francisco, Cal.

HOME STUDY DIVISION
322 Broadway, New York City

RADIO INSTITUTE OF AMERICA
322 Broadway, New York

Please send me full information about your Home Study Course of radio instruction.

I am interested in the complete course including code instruction.

I am interested in the technical course without code instruction.

Name

Address

LETTERS TO THE EDITOR

Continued from page 40

extra 45 volts (above 90) which he claims would be desirable, would there still be enough voltage left to give the right sort of amplifying characteristic? Suppose the plate resistor is one of the commonly sold 100,000 ohm units; now if even as little as 1 milli-ampere is flowing and assuming that the resistance is constant we see at once that 100 volts is the drop across the resistor and leaves only 35 volts effective on the plate of tube. With this low plate potential we do not often get good amplifying characteristics. If the plate current dips down when signals are impressed then we are working too near the upper bend of the characteristic, such as it is, and the complex audio frequencies are not faithfully reproduced by the tube in spite of the fact that it is saving plate battery current. If such an arrangement sounds better than the average transformer coupled amplifier, then the transformers must be little short of rotten. And the general run of transformers has been poor from a true reproducing point of view. However, it has been optimistic to note from month to month that better transformers have come out, and with hints here and there that some real good ones are about to be released for those willing to pay the price of the improved designs.

But as matters stand today, for those who want to be exacting (as they really should be) about their audio amplification and yet have only 120 to 150 volts available, let them look to an impedance coupled amplifier of proper design.

Yours very truly,
H. B. DAY.

A Literalist

Sir: I have been doing some work on my radio as you say in your Nov. radio on pages 17-18. I have some trouble. You say to "Fill up the hole with little chunks of hard rubber bitten out of a hard rubber panel." There is the directions as you say them. This is the trouble. I have tried to bite the chunks of rubber from a panel and have broke two of my best teeth biting it and it wont bite. Also when I mak it hot enof to bite chunks it burns to much to bite it. Plesse rite to my address and tel me how to bit it without breking eny more teth as I dont have eny more to spar just now.

H. EREME NORMA.
Connellsville, Pa.

Liability in A. C. Filament Lighting

Sir:—We wish to call your attention to a situation with which we feel sure you are not familiar.

In your September issue, in the article on the BEST circuit, you advocate the use of A. C. to light the filaments on power amplifier tubes. This is neither new nor startling in principle; we have been using a slightly less efficient system for two years and magazines and newspaper articles are describing the use of the house current for some time.

But—and here is the important thing—the use of such a system places a violation on the dwelling in which it is operated and makes the fire insurance policy invalid.

Article 37, paragraph 3701 B. of the 1923 National Electrical Code reads as follows: "Transformers, voltage reducers, keys and other devices employed shall be of types expressly approved for radio operation." In the 1924 edition of the List of Inspected Electrical Appliances issued by the National Board of Fire Underwriters through the Underwriters' Laboratories, the only "voltage reducers" approved are the Western Current Supply Sets, types LA and 2A. The Suburban Insurance Exchange of 123 Williams Street, New York City, who handle all inspections for this territory, are sticking

Continued on page 90

The Importance of Good Radio Panels

An inferior panel will reduce the efficiency of your reception through surface leakage. You can avoid this by building your set with

ELECTRASOTE TRADE MARK PANELS



These beautifully finished panels will neither warp nor change color. They are scientifically constructed to reduce surface leakage to a minimum, hence assure increased efficiency of the set.

One of the famous "sote" products introduced by The Pantasote Company, Inc., Electrasote Radio Panels are sold strictly on their merits—yet are

Lower Priced than other standard panels

Make your Set an "Electrasote Panel Set"—and get results!

On sale at good Radio Dealers

M. M. FLERON & SON
Inc.

Sole Sales Agents

Trenton, New Jersey

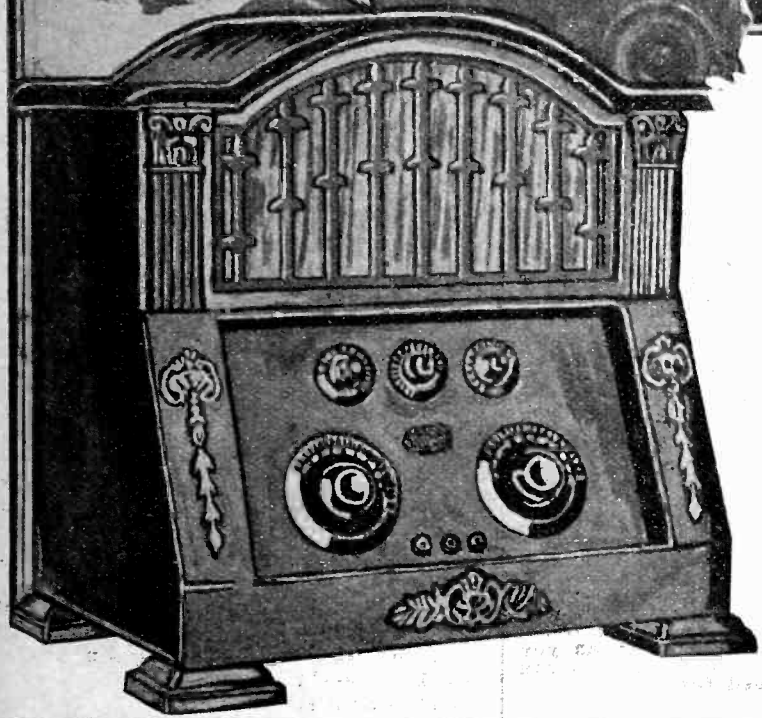
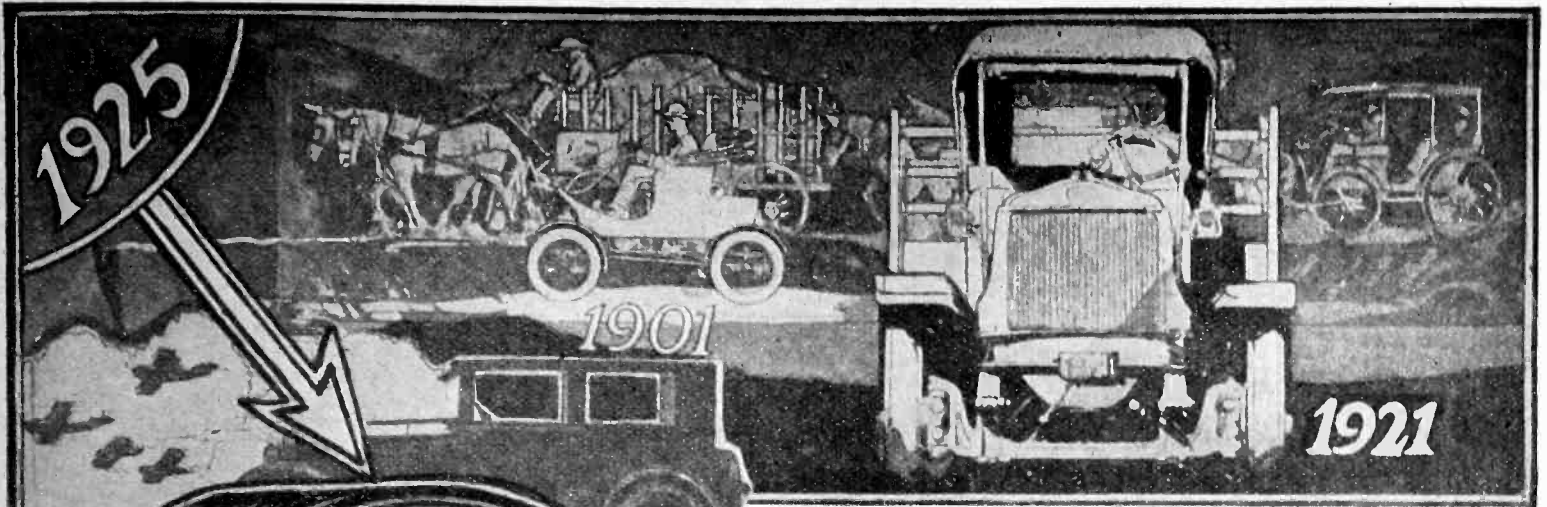

Bestone V- \$60

There is prestige in owning a Bestone V-60.

The inside is mechanically perfect. The outside is a superb piece of furniture.

There is philosophy in buying the best. Henry Hyman & Co. have been in business long enough to know the value of manufacturing superior goods.

"Just as good" means nothing. We call the Bestone V-60 the "Aristocrat of Radio." One

look at it and the pride of ownership is yours without apology.

We lay particular emphasis on the tone qualities. Sublimity of perfect tone, entirely free from distracting noises and distortion.

Volume, distance and selectivity—so simple.

We welcome comparison. In justice to your taste and purse see and hear the new

BESTONE V-60

The Bestone V-60 five-tube receiver in beautiful, distinctive antique polychrome cabinet, with built-in high-grade loud-speaker and battery compartment—

New Popular Price, \$150.00. West of the Rockies, \$165.00

Bestone V-60 five-tube receiver, Imperial Model, in beautiful, polished mahogany cabinet—

New Popular Price, \$100.00. West of the Rockies, \$115.00

Manufactured, Guaranteed and Distributed by

Henry Hyman & Co. Inc. 478 Broadway, NEW YORK
212 W. Austin Ave., CHICAGO



THE SENSATION OF EVERY RADIO SHOW



If your dealer cannot supply you, order direct and we will ship parcel post C.O.D.

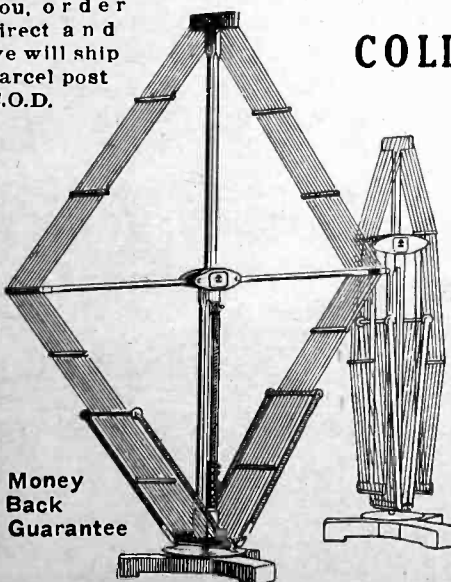

Money Back Guarantee

The New 1925 D. T. W. COLLAPSIBLE IMPORTED GERMAN LOOP \$25.00

Formerly \$35.00

The one piece of Radio Apparatus acknowledged universally by Radio manufacturers to be superior. There is no secret about its selectivity, due to:

1. Its plan of construction.
2. Superior quality of materials.
3. Careful attention to every detail of construction.

The inductance consists of 14 turns of Real Litzendraht, made up of sixty strands of Number 38 gauge enamelled copper wire woven into three cables of 20 strands, which in turn are wound into one strand with double silk insulation. The wire is connected into plots or sections to a series of binding posts located on the upright arm, giving a wave-length range of 100-400, 200-600, and 250-800 meters. Our method of not tapping, but cutting the inductance prevents dead end losses. A table graduated into the degrees of an arc is placed at the base of the loop so that the angle of reception can be accurately determined. The loop is a distinctive instrument of truly scientific nature and uncommon beauty, which will add a thrill to the performance of your set and bring in stations you never heard before.

From the Boston Traveler: "Masterpiece in construction—having no equal made in this country."

From S. Kruse, Technical Editor Q. S. T.: "Appearance and construction excellent. Certainly is a wonderful job."

John Schantz, American Institute of Electrical Engineers: "Nothing more can be said, nothing more need be said about it. The results are beyond my expectations."

Manufactured by the Deutsche Telephonwerke und Kabelindustrie of Berlin, Germany, makers of telephone and scientific apparatus since 1867 and now employing over 6,000 skilled mechanics.

Usual Discounts to Radio Dealers

Tobe C. Deutschmann
American Representative and Distributor
46B Cornhill, BOSTON, MASS.
Reference: First National Bank, Boston, Mass.

\$25.00

Shipped in a permanent, cylindrical container.

Formerly \$35.00

West of Chicago \$1.50 Additional



Above: 40 Ft. Mast in Yard
Right: 20 Ft. Mast on Roof of Apartment House.

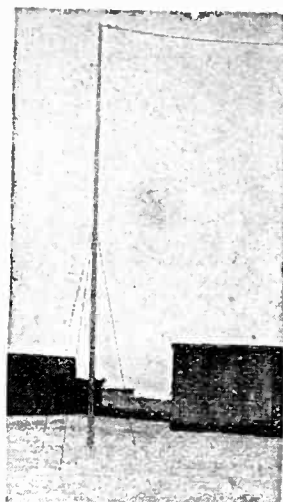

The HERCULES

AERIAL MAST

This Mast is made in sizes to get 20 ft., 40 ft., or 60 ft. clearance and is the answer to an efficient aerial system. This graceful Mast is an improvement to any property whether it is installed on the roof or in the yard. A pulley is furnished at the top for raising and lowering the antenna. All parts are made of steel and are light and strong. This Mast will safely stand a 500-pound pull at the top and support a 6-wire cage antenna. We furnish complete blueprint plans for erecting the Mast and it can be erected in a few minutes. It is shipped in sections for convenience in handling. The 20 ft. Mast weighs 40 pounds, the 40 ft. Mast weighs 100 pounds and the 60 ft. Mast weighs 200 pounds. Guy wires are spaced 120 degrees, or three equal spaces, 4 ft. from the base of the 20 ft. Mast, 8 ft. from the base of the 40 ft. Mast and 10 ft. from the base of the 60 ft. Mast.

LONG RANGE RADIO RECEPTION

It has been said time and again that the best results are obtained only by the intelligent use of the best apparatus procurable. This applies not only to the receiving set proper, but also to the antenna system. **THE AERIAL MUST BE EFFICIENT** if the reception of long distance stations, theoretically within range of the receiver, is desired.

PROPER AERIAL CLEARANCE

Very few novices realize the importance of good aerial installation. The feeble currents from long distance stations will never reach the receiving set if the aerial is strung too close to surrounding objects that tend to absorb the energy. It is this interference that we have experimented with for years—and present the answer—**THE HERCULES AERIAL MAST.**

HAVE BUILT RADIO TOWERS FOR YEARS

For years we have been building radio towers for important broadcasting stations. Included among the names of our customers is the **UNITED STATES GOVERNMENT SIGNAL CORPS.** Only after years of experience and development work have we been able to perfect this wonderful Steel Aerial Mast to sell at a price within reach of the amateur.

S. W. HULL & CO., Dept. G-1
2048 E. 79th St. CLEVELAND, OHIO

20 Ft. Mast, \$10
40 Ft. Mast, \$25
60 Ft. Mast, \$45

We pay the freight

GIVE YOUR SET A CHANCE GET RESULTS!

Not only will the proper aerial clearance, thus obtained, give you the pleasure of long distance radio reception, but the appearance of this beautiful Mast on your property will give you a reputation. This reputation will grow as you bring in stations such as you never hoped for.



Mail Coupon for Literature

S. W. HULL & CO.,
Dept. G-1,
2048 E. 79th St.,
Cleveland, Ohio

Without cost or obligation on my part please send me your latest literature and full particulars of your **HERCULES AERIAL MAST.**

Name.....

Address.....

City.....

The **FEBRUARY** ISSUE of "RADIO" will be a knockout

FARAWAY RADIO



\$29.50
Gets stations Far and near Loud and Clear

FARAWAY Radio Sets are amazing values at bargain prices. Users get stations from New York to Frisco—loud and clear. Operate with either dry cells or storage batteries. Beautiful cabinet finished in mahogany with new platinum-finished panel. **SATISFACTION GUARANTEED.** Don't pay \$100 to \$150. Write for our money-saving plan and literature.

2-Tube Set - \$29.50
4-Tube Set - 59.50

Dealers - Agents: Biggest possibilities you ever heard of. Write for plan and territory quickly.

THE FARAWAY RADIO CO., 659 W. THIRD ST., CINCINNATI, O.

RADIOCAST WEEKLY

48 Pages of Programs, Photos, Humor, Musical Reviews, Schedules, Tables, Editorials, Etc.

5c Per Radiocast Weekly
Copy 433 Pacific Bldg.,
SAN FRANCISCO

Continued from page 88

strictly to the letter of these rules and are refusing to approve installations using a bell ringing transformer regardless of how the transformer is connected to the 110v line.

It is not necessary to point out to you the advantage to the battery companies of this ruling nor the harm it is doing to the scientific development of radio. Because you are inadvertently putting your readers in the position of failing to collect on a possible fire insurance claim we are calling this to your attention. As you know, fire insurance companies are only too glad of an opportunity to escape the payment of policies and have seized upon technical excuses less obvious than this to evade responsibility, so that it is safe to assume that such an installation of A. C. might ruin a claim regardless of the cause of the fire.

Yours very truly,

J. L. NEFF.

Rockville Center, N. Y.

The Jap Code

Sir: With reference to the Jap Code article in September, 1924, RADIO, I am enclosing a complete copy of the same; this includes the 26 diacritical marks, which, contrary to Mr. Mathison's experience, I found to be much in use among the Japanese stations. This code can be used if the Opr. has a few years to spare to study the Japanese language, otherwise I don't believe it could be translated (even if copied), as the Japanese Ops. don't pause, to speak of, after each word.

I've sent pos'n reports, exchanged greetings, etc., OK, but "ND" on anything like a sentence or conversation in the Jap code at all.

Here's how it sounds in Continental with the letters run together:

Thanks (Arigato)—Mw g li ui u.

Yokohama—M ot b x.

Kobe—Ot u ei.

G. M. (Ohayo)—As b m.

G. N. (Oyasumi)—As w oa ua, etc.

I hope this will prove of interest.

G. R. MACKIN

San Francisco.

A	-----	Nu	-----
I	---	Ne	-----
U	---	No	-----
E	-----	Ha	-----
O	-----	Hi	-----
Ka	-----	Fu	-----
Ki	-----	He	-----
Ku	-----	Ho	-----
Ke	-----	Ba	-----
Ko	-----	Bi	-----
Ga	-----	Bu	-----
Gi	-----	Be	-----
Gu	-----	Pa	-----
Ge	-----	Bo	-----
Go	-----	Pi	-----
Sa	-----	Pu	-----
Shi	-----	Pe	-----
Su	-----	Po	-----
Se	-----	Ma	-----
So	-----	Mi	-----
Za	-----	Mu	-----
Ji	-----	Me	-----
Zu	-----	Mo	-----
Ze	-----	Ya	-----
Zo	-----	Yu	-----
Ta	-----	Ye	-----
Chi	-----	Yo	-----
Tsu	-----	Ra	-----
Te	-----	Ri	-----
To	-----	Ru	-----
Da	-----	Re	-----
Dzu	-----	Ro	-----
De	-----	Wa	-----
Do	-----	Wi	-----
N	-----	Wo	-----
Na	-----	Aru	-----
Ni	-----	Ashi	-----

CALLS HEARD

Continued from page 46

By "LR" and "VK"

At KDPU (Big Creek, California)

2bnu, 2cnc, 3lg, 4jr, 4cr, 5uo, 5hp, 5ajl, 5amw, 5afu, 5ew, 5aex, 5ahd, 5gu, 5xa, 5bj, (6's too numerous) 7mt, 7ob, (7un, 7uv) gra?—9cee, 9dbr, 9ell, 9bpu, 9bpt, 9la, 9abf, 9eaq, 9bob, 9aks, 9efy, 9ahz, 9bdq, 9cea, 9cuc, 9bnu, 9bvn.

By 8DJT, Ronald McGinnis, 1214 Faulkner St., Pittsburgh, Pa.

1all, 2apm, (2egf), 2cty, (2ctz), 3cc, 3sm, 3tr, 5aaz, 5aly, 5ck, 5ft, 5nj, (5sr), 6awt, 6bmn, 8aey, (8aog), (8bbf), (8bbl), 8ben, (8bgw), (8bmy), (8boa), 8boq, 8boy, 8brd, 8brj, (8bqu), 8cea, (8cen), 8cbx, (8cib), 8cgf, (8ckm), 8coe, (8csr), 8cta, 8cuc, 8cvo, 8dfo, 8dgm, (8dhd), 8dkr, 8djp, 8dme, 8dmf, (8dnf), (8en), 8rj, 8sm, 8st, 8tt, and others too numerous. 9ado, (9agz), 9aim, 9ajg, 9amu (also on phone, 9awf, 9bdu, 9beg, 9bfd on phone, 9bhi, 9bvx, (9bvm), 9ccj, 9cee, (9cfk), 9cnx, 9csg, 9cm, (9dap), 9den, 9eb, (9eji), 9eky, 9ep, 9kw.

By 7ZU, Polytechnic, Ont.

1abe, 1ajy, 1ar, 1avr, 1bdq, 1bdx, 1bgz, 1bw, 1bze, 1cmp, 1fd, 1sf, 1xw, 2aay, 2ag, 2ame, 2anm, 2apy, 2bqw, U-2by, 2by, 2cee, 2crk, 2ct, 2ha, 2il, 2kee, 2kf, 2ku, 2kv, 2nu, 2qs, 2sa, 2yb, 3afj, 2aq, 3bhv, 3bdo, 3bta, 3cel, 3cfn, 3ck, 3d, 3dq, 3dz, 3iq, 3lg, 3wb, 3xe, 4ab, 4ax, C-4ax, 4br, 4cb, C-4ads, C-4dq, C-4pq, 4eq, C-4fn, 4io, C-4hh, 4kt, 4kv, 5my, 5mi, 4oa, 4rr, 4tj, 4wb, 4xe, 4zd, 5abe, 5ac, 5ail, 5aj, 5afn, 5ajp, 5amo, 5ah, 5aqa, 5ame, 5ap, 5aw, 5anw, 5ce, C-5ds, 5fn, 5la, 5nl, 5nt, 5ot, 5ox, 5ov, 5se, 5ue, 5vv, 5yd, 5za, (6abel), 6aad, 6abe, 6aao, 6adm, 6adb, 6ad, 6adt, 6acu, 6afq, 6age, 6agk, 6alw, 6amo, 6awk, 6awt, 6bua, 6bua, 6bou, 6bae, 6bg, 6bqr, 6bna, 6bka, 6bma, 6buh, 6chl, 6cbb, 6cpw, 6cgv, 6cm, 6cax, 6cmv, (6cuf), 6cgs, 6cto, 6can, 6cel, 7gr, 6ey, 6gr, 6gl, 6gg, 6im, 6lv, 6nx, K-6o, 6os, 6oh, 6wt, 6wr, 7ajy, 7asv, 7ar, 7acf, 7ac, 7aim, 7age, 7abb, 7adf, 7ao, 7all, 7ajt, 7akk, 7ald, 7bz, 7cw, 7cu, (7co), 7cf, 7dd, 7dz, (7df), 7dm, 7ed, 7er, 7fa, 7fd, 7gr, 7gn, 7gq, 7gv, (7il), 7ij, 7ie, 7iv, 7js, 7kr, 7md, 7hf, 7mp, 7nx, 7no, 7nq, 7nt, 7ob, 7pp, 7qd, 8acv, 8avx, 8apt, 8anp, 8ars, 8aps, 8ah, 8apr, 8atp, 8axo, 8bfe, 8bjy, 8bau, 8bs, 8byn, 8bfe, 8bqr, 8bxh, 8cct, 8chy, 8cvt, 8ced, 8ckd, 8cao, 8dat, 8dbm, 8dgo, 8df, 8dfo, 8dwr, 8dkn, 8dnx, 8dal, 8drt, 8dea, 8do, 8dfe, 8dgo, 8dea, 8ed, 8er, 8fm, 8fd, 8gh, 8hf, 8nx, 8ro, 8sf, 8wx, 8wz, 8xe, 8zy, ner, nkk.

9BJI, Denver, Colo.

CW: 1aac, 1agh, 1agk, 1ajw, 1bfq, (1bgq), 1bhn, (1cmp), 1dd, (1gv), 1hn, 1kc, 1my, 1ow, 1sf, 1xu, 1xw, 1xz, 2aay, 2ana, 2anm, 2brb, 2cee, (2chz), 2cnk, (2cyu), 2cyq, (2czr), 2mu, 2pd, 2ud, 2xbb, 2mk, (3alx), (3auv), (3bdo), 3bhv, 3btu, 3bpb, 3bwj, 3bz, 3cdg, 3cfc, (3chg), 3ck, 3ca, 3cd, 3fp, 3na, 3og, 3tp, 3zo, 4ai, 4bq, 4ml, 4pb, 4qf, (4rr), (4sa), 4tn, 4xe, 8aal, 8abm, 8aco, 8ajy, 8apr, 8atp, 8avl, (8bau), 8bbi, 8bdw, 8bfe, 8bjv, 8bhu, (8bhj), (8bpu), 8bqr, 8bsa, 8bsu, 8buk, 8btf, 8byn, 8caz, 8ced, (8cjp), 8cko, 8clc, 8coo, 8cyl, 8dal, (8dea), 8dgt, 8dhw, 8die, 8dmt, 8ef, 8ju, (8pl), (8ve), 8vq, 8yx, 8xe, Can.—2cg, 3co, 3fu, 4gt, 4hh, 5go, Mex.—bx, (one b), Naval—nkf, (nfv).

On 75 to 80 Meters—By W. T. Campbell, 6CMI, Box 131, Sta. G. Oakland, Calif.

(1bgq), 1er, (1gv), (1ii), 1ke, 1sf, 1sz, (1xz), 1xzl, (1zs), 2aay, (2brb), 2gk, 2mu, (3edg), (3bdo), 4bq, 4ku, (4tj), 5ae, 5afw, 6am, 5ame, 5abe, 5afn, 5ail, 5ajt, (5ajl), (5gk), (5jf), 5ml, (5av), 5ph, 5rh, (5za), (6bka), (numerous sixes wkd over 500 miles in daylight), (7zn), (7sy), worked at 3 p. m.; (8ah), (8bau), 8bjv, 8bpa, 8cy, 8fm, (8zg), (9aju), 9aod, 9ap, (9bm), (9bmx), (8bye), (9ccx), (9cju), (9cje), (9clq), 9ctr, (9ded), 9dfz, 9dqu, (9dyt), 9efy, 9egu, (9eht), 9elp, (9hk), 9vz, (9xbg), 9xl, 9zd, (9zt), Transmitter 50 watts all cards answered.

By 5ADE, 14th and Youngs Blvd., Oklahoma City, Okla.

1all, 1gv, 1nv, 1xak, 2aop, 2by, 2cee, 2cgb, 2ga, 2mc, 3btu, 3hd, 3xi, 4dt, 4jr, 4kk, 4pb, 4si, 4tj, 4ts, 4vp, 4xe, 6aao, 6acu, 6adt, 6afy, 6ahp, 6alw, 6atf, 6avb, 6azg, 6bbh, 6bcp, 6bqa, 6bqc, 6buh, 6cds, 6cek, 6cgo, 6cgv, 6chl, 6crx, 6css, 6cto, 6cwx, 6djj, 6ir, 6jl, 6jp, 6jr, 6nt, 6rn, 6xbw, 7akk, 7dh, 7gr, 7no, 8ajf, 8alw, 8alx, 8apt, 8apw, 8axf, 8bbw, 8bdc, 8bdk, 8bhg, 8bn, 8nnh, 8boc, 8boe, 8brj, 8btf, 8ced, 8cjm, 8cke, 8cnb, 8cng, 8cuk, 8cv, 8cwk, 8cvt, 8dal, 8daw, 8dbm, 8dbo, 8dea, 8dfm, 8dgl, 8dgo, 8doo, 8dqf, 8drp, 8gt, 8gz, 8jl, 8rb, 8tt, 8wg, 8ze, 8zg, 8zy, 9aao, 9aar, 9aax, 9adk, 9aed, 9aef, 9af, 9afq, 9afy, 9ahj, 9ahv, 9aif, 9akd,

Distant Stations with Volume

through local interference, can best be obtained with the new

Model 122

Chelsea Receiver

A highly selective, triple circuit, single tuning control, three tube regenerative receiver

Plenty of volume on both local and distant stations to operate a loud speaker and fill your living room with entertainment for the entire family.

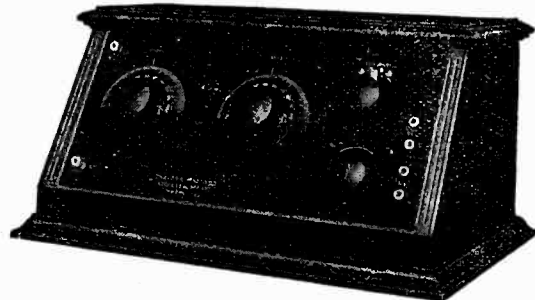

Licensed under Armstrong Pat. No. 1113149

The highest possible efficiency is obtained with CHELSEA receivers because only the highest grade material is used in their construction.

For \$40.00 you get performance equal to that obtained with sets costing from three to four times as much.

Chelsea offers a complete line

No. 107 four tube radio frequency set \$75.00	No. 115 two stage amplifier \$16.00
No. 122 three tube triple circuit set.... 40.00	No. 41 Rheostat dial, 2½-in. .40
No. 110 single tube regenerative set.... 18.00	No. 60 Standard tube socket .75
No. 10 23 plate condenser with dial..... 4.50	No. 43 3-in. bakelite dial..... .45
No. 25 Universal rheostat with dial..... 1.40	No. 44 4-in. bakelite dial..... .60
No. 50 Audio frequency transformer.... 4 50	No. 61 199 tube socket..... .50
No. 95 variocoupler with dial..... 4.50	

Write for new catalog No. 12

Chelsea Radio Company

179 Spruce St., Chelsea, Mass.

Chicago
580 E. Illinois St.
Cleveland
1531 W. 25th St.

Philadelphia
611 Widener Bldg.
San Francisco
477 Pacific Bldg.

St. Louis
1127 Pine St.
Seattle
116 13th St. N.

Denver
1420 16th St.
Los Angeles
1113 Wall St.

A Pair of Headphones Free

WITH only one subscription to "RADIO" for one year (\$2.50) we will give you a pair of 2000-ohm "PENNSYLVANIA" phones free.

THIS offer is good for the months of October and November only. Get your subscription and \$2.50 in the mails right now. Phones shipped on day order received.

PACIFIC RADIO PUB. CO., Pacific Building, San Francisco

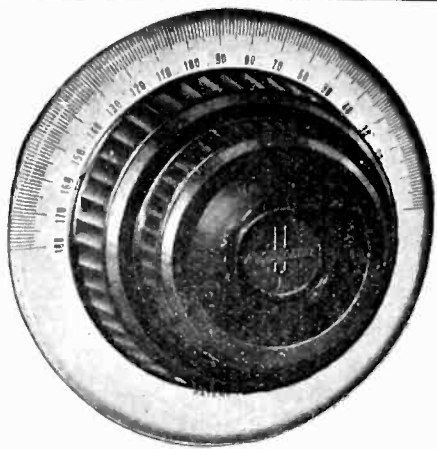

All Wobble Eliminated by Long Center Bushing

Watch the new model Accuratune when you tune in—how smooth it operates—how precise its movement without the slightest indication of wobble.

Few vernier dials built as they must be to take all standard condenser shafts, are designed as the Accuratune to positively eliminate this universal objection—dial wobble.

And just this one point of refinement characterizes the complete makeup of the Accuratune Micrometer Control—features that assure most unusual tuning efficiency. Micrometer Control easily replace ordinary dials without any set alterations. Just tighten the set screw on the large knob.

NEW ACCURATUNE FEATURES:
 Geared 80-1 ratio
 No back lash
 No cutting of condenser shafts
 Flush panel mounting

At your dealer's, otherwise send purchase price and you will be supplied postpaid. Price \$3.50.

ACCURATUNE
 REGISTERED GEARED 80:1 U.S. PAT. OFF.
 MICROMETER CONTROLS

MYDAR RADIO COMPANY
 9-G Campbell Street, Newark, N. J.
 Canadian Representative:
 Radio Ltd., Montreal

The FEBRUARY ISSUE of "RADIO" will be a knockout

SEND NO MONEY!

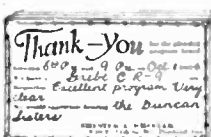

YOUR OWN Name and Address Printed Free on Thank You Cards. Hear what YOU like. Stations are glad to put on numbers at your request. We print Special cards that get ATTENTION. At the RAGE. Cards (Printing FREE, 100—only \$1.35; 200—\$1.65; 500—\$2.35, plus few cents postage. Order TODAY. MONEY REFUNDED if Not Delighted. Quality cards. High grade printing. Send no money—just pay postage when you get cards. Order NOW!

RADIO PRINTERS, 3471 Main St., Mendota, Ill.

TELOS RADIO

Write for a free copy of our new, handsomely illustrated booklet, "The KIT of a Thousand Possibilities."

DANZIGER-JONES, Inc.
 Dept. F, 25 Waverly Place
 New York, N. Y.



\$1.10 Write for **FREE** Hook-Ups
 Everywhere

No rheostat knobs on panels to turn—no meters needed—no tube worry. One ampere, used in series with each tube, inside the set, automatically supplies just the right current for each individual tube's greatest efficiency. Works on thermo-electric principle. Simplifies wiring. Reduces set cost. Proved in use. Adopted by more than 50 set manufacturers. No set is up-to-the-minute in design without it.

RADIALL COMPANY, Dept. R. 6
 50 Franklin Street, New York

AMPERITE

"means right amperes"

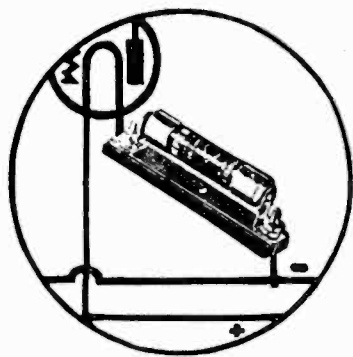

Recommended in

BEST'S Super-heterodyne

Fully described in this issue of "Radio"

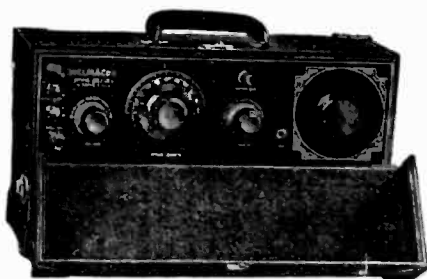

RADIO'S WONDER CIRCUIT!

4 Tubes Do the Work of 7 in the

Telmaco P-1 Receiver

Coast to coast reception. Aerial, loud speaker and batteries self-contained. Carry from room to room—take it anywhere. Ask your dealer or write us. Free descriptive folder.

Radio Division

TELEPHONE MAINTENANCE CO.
 20 S. Wells Street, Dept. A, Chicago, Ill.
 Quality Radio Exclusively Since 1918

9aki, 9akk, 9akh, 9ala, 9amf, 9aml, 9anh, 9aor, 9asa, 9asv, 9ato, 9auc, 9auy (gra?), 9avb, 9awv, 9ayb, 9az, 9bbh, 9bbw, 9bcb, 9bdb, 9bdf, 9beg, 9bfg, 9bhc, 9bhl, 9bh, 9biq, 9bis, 9bjl, 9bkb, 9bmk, 9bmw, 9bnk, 9bob, 9boy, 9bph, 9bpn, 9bre, 9bsm, 9buh, 9bv, 9bxh, 9bxl, 9bxt, 9byj, 9bz, 9ca, 9cag, 9caj, 9cas, 9ceb, 9cek, 9cef, 9cgr, 9che, 9cic, 9cmt, 9ckb, 9ckd, 9ckh, 9ckr, 9ckl, 9clz, 9cmr, 9cmp, 9csg, 9cuf, 9cuc, 9cvf, 9cvl, 9evn, 9cwk, 9cya, 9dac, 9dau, 9dbr, 9dbw, 9dbz, 9dch, 9ddp, 9del, 9den, 9deg, 9dfh, 9dfm, 9dfv, 9dge, 9dgg, 9di, 9did, 9dij, 9djp, 9dkv, 9dlw, 9dpu, 9dq, 9dqf, 9drj, 9dru, 9dsr, 9dt, 9dvt, 9eak, 9eam, 9eba, 9ebh, 9ebq, 9eby, 9ecv, 9eco, 9ef, 9efc, 9efd, 9eff, 9efz, 9egu, 9ej, 9ejq, 9ejy, 9ek, 9em, 9er, 9fj, 9fp, 9kp, 9kq, 9la, 9ml, 9nv, 9nw, 9ph, 9ud, 9uk, 9vc, 9vbb, 9vt, 9zz.

Would be glad to trade station photos with anybody. Like 2 gt sum crds rptg me. (H) QRK 10 watt AC & MG.

By R. W. Minstrom, 62 Barton St., Woolston, Christchurch, N. Z.

1aac, 1gv, 1sf, 1ng, 1xav, 2aay, 2brb, 3sw, 4fs, 4oa, 4sa, 5gl, 5ph, 5nj, 5ve, 5aaq, 5afn, 5ajj, 5air, 5cto, 5br, 5bep, 5cwg, 5rn, 6el, 6ac, 6bfw, 6bra, 6ar, 6aao, 6cfz, 6awp, 6brq, 6bu, 6avj, 6cqe, 6gt, 6cae, 6ebb, 6apw, 6cl, 6bur, 6cej, 6lj, 6cgs, 6age, 6ur, 6bd, 6chl, 6cjr, 6agk, 7af, 7fr, 7aim, 7fd, 7ij, 8dhw, 8cy, 8ah, 8gz, 9auc, 9bou, 9gy, 9bez, 9ca, 9dnp, 9cee, 9bm, 9ddp, 9bo, Can., 5go, South America, ch8, db2. Will get any of above.

At GATH and BRSC, F. M. Gulick and C. E. Gulick, Orange, Calif.

1abf, (lare), 1anr, (lwa), 1aww, 1boa, (1bhm), 1bvl, 1cmc, 1cmp, 1ga, 1gv, 1kc, 1on, 1ow, 1pl, (1py), 1sf, 1xam, 1xav, 1xz, 2aay, 2ana, (2brb), 2cel, 2chk, 2cjj, 2cvi, (2cvu), 2dn, 2gk, 2ku, 2mc, 2ud, 2add, 2adn, 2aec, 2aix, 2auv, 2bc, 2bfe, 2bhv, 2bof, (2cdg), (2chg), 2hh, (3jo), 3ms, 3ot, 3sf, 3qv, 3wb, 3xl, (4al), 4bq, 4cl, 4fv, 4tz, 4io, 4oa, 4rh, 4st, 4tj, 4uk, 4ux, 4xe, 5adh, (5aex), (5afn), 5amg, 5amh, 5amu, (5amw), 5all, 5alj, (5alj), 5he, 5cn, 5dw, 5in, 5il, 5ml, (5nw), 5oq, 5ot, 5ov, (5ox), 5ph, 5ql, (5qy), 5rh, (5se), 5uj, 5uk, 5xau, 5zas, (5zav), (6arx), 6buh, 6rm, (6rv), (7abb), 7ahl, 7bq, 7g, (7gm), 7gr, 7ij, 7ix, 7ku, (7oy), 7pq, (7qd), 7rh, (7sy), 8ada, 8aey, 8ah, (8alf), 8aro, 8avl, 8ayu, 8bau, 8bfe, (8bhu), (8bnh), 8bf, 8byn, 8caz, (8cbp), 8cmi, 8coj, 8cta, 8cva, (8cyi), 8dae, (8dgp), 8dhw, 8dnf, 8doo, 8er, 8gz, 8jq, (8kc), (8pl), 8up, 8rv, 8tr, 8ze, 9aau, 9aav, 9acl, (9amx), 9axx, 9bcj, (9bdu), 9bag, 9bga, 9bhx, 9bje, 9bjl, 9bm, (9bmx), 9bmv, 9bnk, 9buk, 9bun, 9ca, 9cap, (9cee), 9cfy, 9clp, 9cjc, 9ckb, 9coy, 9crx, (9ctr), (9cxx), 9ded, 9dfh, (9dix), 9dng, (9dqu), 9dtk, 9dvp, 9dxn, 9dxy, (9dyt), 9eak, 9ee, 9fth, 9efy, 9efz, (9-g), 9-hx, 9ej, (9eky), 9ela, 9eld, 9es, 9mn, 9nv, 9ny, (9qw), 9wo, 9xb, 9xl, 9yh, 9zd, 9zt.

Canadian: 1ar, 2be, 3co, 4cr, 5an, 5go, Mexican: (1b), New Zealand: 2ac, 4ak, Commercial: NKF, WGH.

By DAPY 3337 Oak Park Ave., Berwyn, Ill.

1agq, 1aja, 1alw, 1bcc, 1bib, 1cmp, (1hn), 1lm, (2ach), (2acc), (2acf), 2al, (2aoy), 2bdg, (2byg), 2cel, 2cg, (2chz), 2cj, (2cjb), (2cjr), 2cmx, 2cpa, 2czr, 2eg, 2kx, 2wi, (3ach), 3akh, (3apc), 3bj, 3bkl, (3bu), 3buv, (3buy), 3ccu, 3chk, 3hg, 4io, 4kk, 5abc, 5aef, (5aek), 5aep, 5afh, 5agn, 5akp, 5amh, (5anl), 5aom, 5apl, 5apt, 5apz, 5aqw, 5aqy, 5lh, (5qh), (5qy), 5tn, (5vu), 5xa, 5zas, 6bkv, 6zh, 7ge, 8agw, 8apo, (8ben), 8hdk, 8bdw, 8bit, (8brb), (8ct), 8dgl, (8dki), Fones: 4lk, 8br, Canadian: 2ax, 3ph, ABC de WGH (QRA?)

By GRPQ, Milton O. Smith, 504 1/2 North Adams St., Glendale, Calif.

1aac, 1aaf, 1ahf, 1ajj, 1apu, 1are, 1aur, 1bge, 1bhw, 1bvb, 1gv, 1kc, 1mw, 1ow, 1pl, 1rn, 1sz, 1te, 1vj, 2aay, 2ku, 2ana, 2any, 2bhc, 2byn, 2cel, 2cjj, 2ku, 2mu, 3ab, 3bdo, 3be, 3bfe, 3bhv, 3bof, 3cdg, 3hh, 3hs, 3iy, 3sf, 3wb, 4bq, 4fz, 4jr, 4ql, 4sb, 5aal, 5aag, 5acl, 5aef, 5aex, 5ags, 5apc, 5apq, 5dm, 5ew, 5gk, 5jf, 5ml, 5nj, 5ot, 5ql, 5uj, 5wy, 7afn, 7fj, 7fr, 7ku, 7ly, 7nt, 7sy, 8ago, 8ah, 8alf, 8apn, 8atp, 8bau, 8bbf, 8bce, 8bgz, 8bqr, 8htf, 8bxh, 8byn, 8ces, 8ehb, 8coj, 8dgp, 8dhw, 8doo, 8fm, 8jq, 8tr, 8up, 8wo, 8xb, 8ze, 9aad, 9aio, 9apw, 9avv, 9axx, 9bcj, 9bet, 9bfg, 9bht, 9bhx, 9bje, 9bkr, 9bmo, 9bnf, 9bnu, 9bpy, 9bqy, 9bso, 9cap, 9ccx, 9cdo, 9clp, 9cjj, 9cpm, 9cvs, 9dac, 9dbp, 9dev, 9dfq, 9dmj, 9dms, 9dsa, 9egh, 9ej, 9es, 9hk, 9mn, 9of, 9ti, 9vd, 9zb, 9abp, Canadian: 1ar, 5an, French: UFT, US: WYD, QRA?, NFV, QRA?

By 6CLZ, 6COW, 1045 Peralta Ave., Berkeley, Calif.

1aac, 1abf, 1abs, 1aur, 1bep, 1bgo, 1bip, 1bkr, 1bvl, 1cmp, 1co, 1er, 1fd, 1gk, 1gv, 1li, 1kc, 1my, 1ow, 1pl, 1rp, 1sf, 1xam, 1xav, 1xw, 1xz, 1zy, 2aay, 2abd, 2ana, 2awf, 2bgo, 2brb, 2bse, 2byw, 2cel, 2cjj, 2cqz, 2cvj, 2gk, 2ku, 2mu, 2pd, 2adb, 2afj, 2aih, 2auv, 2bdo, 2bhv, 2bsb, 2bss, 2bta, 2cdg, 2ckj, 2bg, 2hq, 2sf, 2zw, 2ai, 2bq, 2eq, 2fg, 2fs, 2fz, 2io, 2ku, 2oa, 2rr, 2tj, 2xi, 2aa, 2acl, 2acm, 2adh, 2adv, 2aec, 2aef, 2afu, 2afu, 2agj, 2agl, 2ajj, 2ail, 2aiu, 2ajb, 2ajh, 2ajj, 2ame, 2amu, 2amw, 2apg, 2be, 2cn, 2cy, 2dw, 2ew, 2gk, 2hl, 2hs, 2in, 2jf, 2kq, 2li, 2lu, 2ml, 2mz, 2nw, 2ot, 2ov, 2ox, 2ph, 2pn, 2qy, 2rh, 2ru, 2sd, 2se, 2uj, 2uk, 2um, 2wy, 2za, 2zai, 2zas, 2zav, 2zc.

Will QSL to ani 6's and 7's wishing ck on thr sigs— 8abm, 8ada, 8adk, 8aey, 8ah, 8aju, 8amr, 8apt, 8atp, 8bau, 8bce, 8bfe, 8bjv, 8bpa, 8bqr, 8buk, 8bxh, 8byn, 8cbp, 8cel, 8cko, 8coi, 8cvm, 8cvi, 8ddw, 8dhw, 8bs, 8ef, 8fm, 8gz, 8kc, 8nb, 8pl, 8up, 8ve, 8vq, 8vt, 8xb, 8zy, 8zz, 9aad, 9aau, 9abf, 9afu, 9agl, 9aod, 9aol, 9apk, 9ari, 9arm, 9avv, 9awm, 9axs, 9bch, 9bcj, 9bdu, 9bdw, 9bfg, 9bf, 9bgh, 9bht, 9bhx, 9bq, 9biz, 9bje, 9bji, 9bko, 9bkr, 9bkk, 9bmr, 9bmu, 9bmx, 9bnf, 9bnk, 9bnu, 9bpy, 9bqu, 9boy, 9bso, 9bvt, 9bye, 9bzg, 9ca, 9cap, 9cbf, 9cbk, 9ccu, 9ccx, 9cdv, 9cea, 9cee, 9cek, 9cf, 9cfy, 9cii, 9cip, 9cjc, 9cjs, 9cju, 9cjl, 9cid, 9clq, 9clx, 9coc, 9cpm, 9crr, 9ctr, 9cyk, 9dew, 9ddp, 9ded, 9dev, 9dfh, 9df, 9dfq, 9dfv, 9dfz, 9djd, 9dmj, 9dnv, 9dpx, 9dqu, 9dvp, 9dxn, 9dxy, 9dyn, 9ebh, 9efu, 9efy, 9efz, 9egh, 9egu, 9ent, 9ek, 9eky, 9eld, 9an, 9ap, 9hm, 9cp, 9em, 9es, 9hk, 9hn, 9mc, 9nv, 9ny, 9ra, 9se, 9wu, 9xbb, 9xbg, 9xbp, 9xi, 9xw, 9za, 9zb, 9zd, 9zt, 9kdf, 9ndf, 9nkr, 9nv, 9kf, 9se, 9wg.

Canada: 3aa, 3bp, 3bq, 4cb, 4cr, 5an, 5ba, 5bf, 5go, 9al.
Hawaii: 6ceu.
Mexico: 1b.
New Zealand: 2ac, 4ak.
All cds answd. QRL 6CLZ—5 watter on 78 meters?

By 6CHL, 3948-26th St., San Francisco, Calif.

1bx, (1gv), 1hn, (1lw), 1cw, 1pl, 1xw, 1abt, 1acr, 1ajg, 1atj, 1aww, 1bq, 1cab, 1cmp, 1cmv, 2by, (2kg), 2mc, 2nf, 2qs, 2rk, 2wr, (2xq), 2bq, 2brb, 2cee, 2chz, 2cjj, 3hh, 3oq, 3ot, 3zl, 3abf, 3adr, (3alx), 3bco, (3bdo), 3bhv, (3bmu), (3bzm), 3bsh, (3chc), 3ccx, (4ft), 4io, (4mb), 4my, 4pk, 5ak, 5ap, (5aw), 5cc, 5ek, 5fh, (5gj), (5gu), 5hl, 5ka, (5lh), 5lu, 5mi, 5mz, (5nj), (5nw), 5ox, 5ph, (5rg), 5rh, 5se, 5uk, 5aec, 5aek, 5afu, 5agj, 5agn, 5ajb, 5akn, (5akx), 5xau, (6aof), (6any), (7mn), 8er, 8jq, 8ze, 8ada, 8aru, (8act), (8axf), 8bit, 8bqr, 8bnh, 8brb, 8cbp, (8cel), (8cpk), 8czy, 8cwu, (8dal), (8dsp), 8dhs, 8dhw, 8du, 8xmo, (9bm), 9hk, 9mf, (9nv), 9ny, (9vc), (9wo), 9yb, 9zb, 9zt, 9aal, 9aaq, 9abq, 9adf, 9ado, 9aemb, 9aep, 9aim, 9aey, (9amx), (9atn), (9awg), (9bcj), 9bdu, 9bfg, 9bhx, 9bjj, 9bkr, 9bmk, 9bnk, 9bqj, 9brx, 9btz, 9bvn, 9bv, 9bz, (9ccf), 9ccx, 9ccm, (9ceg), (9cen), 9cht, 9cfl, 9cjc, 9cju, 9clq, 9cow, 9cpm, 9cro, 9csa, (9cvo), 9cvs, 9dad, 9dau, 9dcp, 9ded, 9dfh, (9dlo), (9dhl), (9dkv), 9dpx, 9dsa, (9dwk), 9dyy, (9eak), 9eam, 9efh, 9efy, 9egu, 9ent, 9ejn, (9eky), 9elb, 9eld.

Canadians: 2cg (5an), (5as), 5ba, 5bj, 5bz, (5cp), 5ct, 5ef, (5gg), 5go, 5kt.
Mexican: (bx).
New Zealand: 2ac, 4aa, ("4ag"), 4ak.
Australian: 2cm.
Will QSL to those requesting cards. QRH now 80 meters.

By 9BJI, Denver, Colo.

1aac, 1abf, 1abt, 1adg, 1aea, 1ald, 1ajo, 1anq, 1anr, (1atj), 1awu, 1aww, (1bal), 1bgq, 1bhm, 1bvl, 1ckp, (1cmp), (1da), 1ec, 1gv, 1fd, 1lv, 1hn, 1lw, 1ml, 1my, (1on), 1ow, 1pl, 1sf, 1sw, 1vj, 1xam, 1xw, 1xz, 1zz, 2aay, 2afp, 2ana, 2apy, (2axf), 2bgg, 2hbn, 2bgo, 2bo, 2bqc, 2bqu, 2bqw, 2bse, 2brb, 2bum, (2chg), 2cje, (2cjj), (2cvs), (2cvu), (2cyw), 2czq, 2ez, 2fo, 2ku, (2mu), 2ud, (2xq), (3ade), 3adp, 3adq, 3adv, 3aec, 3auv, (3alx), (3bdo), 3bfe, (3bhv), 3bmn, 3bpf, 3bpb, 3bss, 3btu, 3bwj, 3ccx, 3cdv, 3cej, (3chc), 3chg, 3cjn, 3cjk, 3hh, 3qt, 3vw, 3wb, (3wn), 3zt, 4ai, (4ch), 4eh, 4eq, 4du, 4il, 4jk, 4jr, 4js, 4ke, 4nj, 4oa, 4pk, 4pl, 4qf, 4rr, (4sa), 4si, 4tj, 4uk, 4xe, 6cen, (8ada), 8amn, 8aol, 8apn, (8atp), 8avl, (8bau), 8bgn, 8bhj, 8bjv, 8bnh, 8bpt, 8br, 8btu, (8buk), 8byn, 8bxh, 8caz, 8cbp, 8ces, 8clc, 8cm, 8cyl, 8dal, 8dgp, (8dhw), 8dol, 8ef, 8ge, 8gz, 8jq, 8kc, 8pl, (8rv), 8ut, 8vt, 8vq, 8wa, (8wo), 8xb, 8xe, 8yn, 8ze, 8zz, (nfv), nkf, wvv.

Canadian: 1ar, 2ax, 2be, 3co, 3bh, 3ly, 3xi, (4FV), (5go).
Mexican: BX, IB.

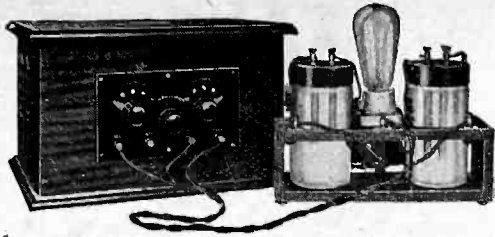

APPLAUSE FROM EVERYWHERE

Our own rigid tests of KIC-O Alkaline "B" Storage Batteries and Chargers are amply confirmed by the comments we receive from all over the United States and Canada. Thousands of unsolicited letters have told us that KIC-O Equipment does what we have designed it to do—insure better reception—lower cost.

PRICES
PZ indicates panel type with switches.
CZ is plain type without switches.

Volt- age	M. A. H.	Type 1/2	Type CZ
130	2500	\$36.00	\$33.00
100	"	27.50	24.50
75	"	21.50	18.50
45	"	16.00	14.50
22 1/2	"		7.50

KIC-O Chargers

Type K-1 single un-mounted	\$1.50
Type K-2 single mounted	3.50
Type K-3 Multi-Polar mounted	5.00
KIC-O Special Charger Chemicals	.75

KIC-O products bear a printed guarantee insuring satisfaction.

Write us or ask your dealer for full information.

KIMLEY ELECTRIC COMPANY, Inc.
2661 Main St. Buffalo, N. Y.



Storage "B" Batteries and Chargers

Heard across the seas

Mr. H. W. MacKelvie, 7 Carlton Terrace, Swansea, South Wales, England, writes: "I was testing my one valve set between 1 and 2 o'clock in the morning when I was surprised to hear K.D.K.A. or Pittsburgh."

Evidently there is no limit to long distance reception with Myers Tubes. Their design is right.

Three types for dry and storage batteries. Complete with clips ready to mount. At your dealer's or sent postpaid for ...

252 Craig Street, Montreal

Myers Tubes

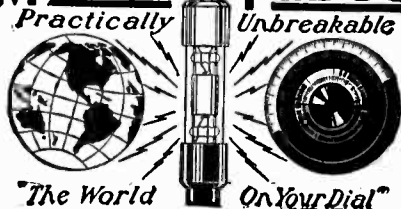

Write for descriptive circular

GET A
LOUD SPEAKER FREE

See Page 79

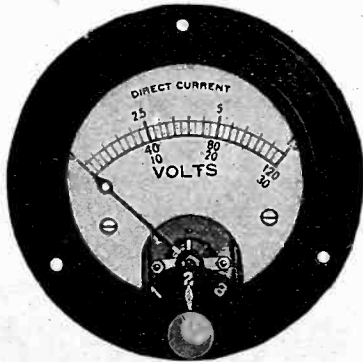

No. 55
Self-contained
Multiple Switch
(Pat. applied for)

Jewell Electrical Instrument Co.

1650 Walnut St. - Chicago

"25 Years Making Good Instruments"

MEASURE-

Your batteries from the panel of your set.

☐ The Jewell No. 55 Instrument has a self-contained multiple switch. We originated this type Instrument for receiving sets and have applied for patent.

☐ Super-Heterodyne Sets with their large number of tubes should have a constant control of "A" and "B" Batteries from panel of set.

☐ Buy from your dealer. Ask for our 15-A Catalog.

The Andrews Deresnadyne

RADIO RECEIVING SET

Combines tone quality and selectivity with distance and volume. Price \$150 without accessories

ANDREWS RADIO CO., 327 S. La Salle St., Chicago

Tell them that you saw it in RADIO

BAKELITE

TRADE MARK REG. U. S. PAT. OFF.



A constant factor in radio development

Radio design progresses rapidly—but radio's standard insulation continues to be Bakelite.

For the further refinement of radio sets and parts, radio engineers rely upon Bakelite. Typical of many new Bakelite applications are the Musette Loud Speaker, the Paramount Loop and the Amsco Tube Mounting Panel.

Of all insulating materials Bakelite alone combines the many characteristics vital to efficient radio reception.

Write for Booklet "S."



BAKELITE
Condensite
REDMANOL
are the registered
Trade Marks for the
Phenol Resin Products
manufactured under
patents owned by
BAKELITE
CORPORATION

Send for our Radio Map

The Bakelite Radio Map lists the call letters, wave length and location of every broadcasting station in the world. Enclose 10 cents to cover the cost and we will send you this map. Address Map Department.

BAKELITE CORPORATION
247 Park Avenue, New York, N. Y.
Chicago Office: 636 West 22d Street
ELECTRICAL SPECIALTY CO.

Western Representative
443 So. San Pedro St. Los Angeles
75 Fremont St. San Francisco
1041 Sixth Ave. Seattle

THE MATERIAL OF A THOUSAND USES

At 8ZE-SGX Oberlin, Ohio

(6aao), 6adt, (6afg), (6agk), 6aha, (6ahp), (6aiq), (6ajh), 6alk, (6ame), 6apw, 6arb, (6arx), 6awt, 6bdt, (6bjj), (6blw), 6bon, (6bqr), 6bqu, (6cgo), 6chl, 6cla, (6cmi), (6cni), (6css), 6cto, 6cvm, 6ac, 6cg, 6eb, (6gt), 6lj, 6lv, 6ne, 6of, (6oi), 6ol, 6pl, (6rm), 6vc, 6vo, 6xl, (6zp), 6z? (hrd 10:35 am Nov. 16th). 7abb, 7afo, 7ajj, 7fd, (7fq), (7gb), 7gr, 7ij, 7ix, 7mf, 7ot
Canada: c4cr, (c5an).

P. R.: 4sa.

Mexico: BX.

England: G5lf.

By 6CUW D. C. Mast, Bisbee, Ariz.

5bj, 5cc, 5ce, 5ck, 5es, 5gu, 5hi, 5ko, 5ld, 5lh, 5ls, 5ms, 5pp, 5qy, 5se, 5uj, 5ux, 5abj, 5abw, 5adv, 5adz, 5aex, 5afg, 5afh, 5agn, 5agq, 5ajl, 5ajv, 5akf, 5alm, 5alu, 5ajt, 5amw, 5apm, 5aqd, 5are, 5zai, 5asb, 6dd, 6fm, 6gv, 6ih, 6jj, 6ld, 6lj, 6oo, 6pz, 6rf, 6uf, 6wt, 6aam, 6abe, 6afg, 6afn, 6aj. 6ajh, 6aji, 6aga, 6akw, 6ano, 6aoa, 6asb 6asv, 6ava, 6bbq, 6bhq, 6bjc, 6bkv, 6bqf, 6btp, 6bts, 6bwl, 6cah, 6cdg, 6cdn, 6cfs, 6cgv, 6cgv, 6chx, 6cje, 6cnk, 6cni, 6cqe, 6ers, 6crx, 6csr, 6csw, 6ctl, 6cto, 6cub, 6xad, 6zhh, 7co, 7ob, 7oi, 7sl, 7ahc, 7ahs, 8doo, 9ea, 9em, 9fm, 9rx, 9wi, 9wo, 9acq, 9alm, 8aob, 8aol, 9atl, 9bcb, 9bdu, 9bez, 8bjk, 8blb, 8bnk, 8bof, 9bqj, 9bsp, 9bxg, 9caa, 9cea, 9cut, 9ckj, 9ckm, 9cid, 9cms, 9czg, 9dhq, 9dhw, 9dhy, 9dov, 9dpp, 9eam

By 2WZ, 654 East 23rd St., Brooklyn, N. Y.

CW U.S.A.: (1bx), (1cg), 1ef, 1fm, 1fd (1gs), 1hr, 1il, 1lj, 1lk, (1kv), (1ky), (1lu), (1ld), 1ql, 1tc, (1um), (1wn), (1wz), 1za, 1zs, (1zk), laam, laay, labf, labp, ladg, lagg, lagk, (1ajg), 1all, (1alk), 1alw, lana, lans, laqm, laqy, late, lavi, (1axa), laxr, laxy, 1bal, (1bbh), 1bcc, (1bch), (1bdx), 1bgq, 1bip, (1bjo), 1bkk, (1blx), (1bnl), (1bqe), 1bsd, (1btt), (1bub), 1cab, (1ccx), (1cev), 1cjd, (1ckp), 1cme, 1cmx, 1cmy, (1cot), 2bm, 2by, 2cdh, (2cpa), 3ca, (3cf), (3ek), (3dx), 3hh, 3in, 3jo, 3mf, 3na, 3og, 3ot, 3sq, 3tp, 3uy, 3wb, 3wf, (3zd), 3zo, (3ach), 3acr, 3adg, 3adp, 3adt, 3aha, 3ais, 3ajd, 3apl, 3apv, 3arp, 3beo, 3bhv, (3blc), 3bng, 3bof, 3bpf, 3bpp, 3bqp, 3bzf, 3buy, 3ccu, 3cdg, 3cdn, 3cdu, 3cge, 3cgy, 3cgs, 3chc, 3chg, 3cjn, 3ckj, 4az, 4bq, 4cl, 4eh, 4fz, 4gw, 4io, 4je, 4ke, 4kk, 4ku, (4mb), (4mi), 4pd, 4pk, 4qf, 4qw, 4rr, 4tj, 4vn, 4xe, 4am, 5be, 5bj, 5cn, 5ek, 5hl, 5ka, 5kc, 5lh, (5lu), 5ml, 5ot, 5ox, 5qh, 5ru, 5se, 5uj, 5uk, 5vl, 5vv, 5wi, 5xa, 5aaq, 5aaz, 5abn, (5acm), 5aek, 5agj, (5alz), 5amg, 5apc, 5apv, 5zas, (5zav), 6ac, 6gu, 6lv, 6ol, 6rm, 6rn, 6zp, 6aao, 6adt, 6ahp, 6alv, 6apw, 6arb, 6awt, 6bjj, 6blw, 6bql, 6buf, 6bur, 6cgo, 6ogs, 6cnl, 6cto, 6xad, 6xbw, 7ij, 7mf, 8ab, 8ah, (8ak), 8bn, 8by, 8cp, 8ef, 8ge, 8gz, (8hn), 8jq, 8nm, 8on, 8or, 8pl, 8qr, 8rg, (8pj), (8sf), (8tt), (8ut), 8uq, 8vq, 8wm, 8wo, (8wz), 8zd, 8ze, 8zz, 8abw, 8acm, 8ada, 8adm, 8agg, 8ago, (8ahq), 8ajn, (8ase), (8atz), 8aum, 8avk, 8axd, (8axg), 8ayu, 8azw, 8bau, 8bbf, 8bbl, 8bbw, (8bdk), 8ben, 8bg, 8bhj, (8bau), (8bko), (8blp), (8boe), 8bos, 8boy, 8bpl, (8bqa), 8bq, (8brb), 8bic, 8brd, 8bsf, 8btf, 8bvr, 8by, (8hzk), (8cbm), 8cbp, 8cbx, (8cck), 8ccr, 8ced, (8cej), 8cep, (8cgr), 7cjp, 8cmm, 8coe, 8coj, (8cse), 8cuk, (8czy), (8dae), 8dal, 8dan, 8dat, (8dea), 8dfb, 8dfm, 8dfo, 8dge, 8del, (8dgr), 8dho, 8djf, (8djp), 8dki (8dli), (8dme), 8dnf, 8dpl, (8dqw), (8drw), (8dsc), 9at, 9bm, 9dr, 9ej, 9ek, 9es, 9fs, 9hp, 9jh, 9kh, 9lz, (9mn), 9nv, 9ny, (9oa), 9of, 9ud, 9vz, 9za, 9zt, 9aan, 9abn, 9ack, 9acl, (9afi), 9afy, (9ahy), 9akn, (9amx), 9aor, 9as, 9att, 9auc, 9avb, 9avy, 9awu 9bcj, 9bds, (9beg), 9bhi, 9bli, 9bji, 9bjr, 9bkr, 9blj (9bmc), 9bmx, 9bna, 9bnk, 9bob, (9boe), (9bpm), (9buk), 9brx, 9bva, 9bvn, (9hwb), 9hwp, 9caa, (9cbz), 9ccm, 9cdp 9cee, (9cfc), (9cfi), 9cgn, 9oks, 9cjc, 9cjm, 9ckb, (9ckh), 9ckl, (9cku), 9ckv, 9clq, 9cpm, 9csn, (9cfr), 9cur, 9cvf, 9cvp, 9cvs, 9cax, (9cyd), 9cyp, 9dat, (9dbh), 9dbp 9dfh, 9dhp, 9dlh, (9dlj), 9dng, 9doz, 9dpx 9dqu, 9dsa, 9dtr, (9dtt), 9duc, (9dwx), (9dwz), (9dxl), 9eas, (9edq), 9eeg, 9eel 9efz, 9egu, 9ehr, 9ehs, (9ehu), 9ehy, 9ejl, 9ejy, 9eky, 9ela, 9ell, 9xhg.
Canada, 1ef, 2ax, 2az, 2bq, 2fo, 3bp, 3kq, 3ly, 3m3, 3ni, (3tf), 3ws, 3wv, 3xl, 4cr 9br.
U. S. A.—1cw, 3tr, 3cit, 8eb, 8ue, nck (nrg), 3ly, 3ms, 3ni, (3tf), 3ws, 3wv, 3xl, Spark—8t).
Special cw—nfv, nkf.
England—2jf, 2kf, 2nm, 2od, 2sh, 2sz 6nn.
France—8ab.
Mexico—1-b, bx.
New Zealand—2ac, 4aa, 4ag.

Continued on page 100



FRESHMAN SUPERIOR

You can depend upon them to remain accurate at all times

Made of high resistance material impregnated throughout (not coated paper). Unaffected by climatic conditions. Will not deteriorate. Clamped between solid knurled ferrules assuring rigid construction and firm contact at all times.

At your dealer's, otherwise send purchase price and you will be supplied postpaid. Chas. Freshman Co., Inc., 106-7th Ave., N. Y.

40c

each in any value from 1/4 to 10

The Powerful



Made by The GAROD CORP. 120 Pacific St. Newark, N. J.

RADIO CATALOG

100 Live Pages Full of Information

Contains interesting explanation of various benefits of Radio which you may enjoy told in language anyone can understand. You should get it before buying.

(And will you be so kind as to add the name of one or more friends you believe will soon want this good? Thank you!)

Liberty M. O. House, Dept. A674 100 Liberty St., N.Y.



Send for it TODAY!

Why it is Better

THE picture tells the story—seven practical, sensible reasons why Federal sockets should be in your “pet” hook-up.

Federal Sockets are but another evidence of the care and engineering skill used in designing and making Federal Standard Radio Parts.

There are over 130 standard parts bearing the Federal ironclad performance guarantee—their use means “Balanced Circuits” with better performance.

FEDERAL
TELEPHONE & TELEGRAPH CO.
Buffalo, N. Y.



Federal

Standard **RADIO** Products

Boston New York Philadelphia Chicago
Kansas City San Francisco Pittsburgh
Washington, D. C. Bridgeburg, Canada

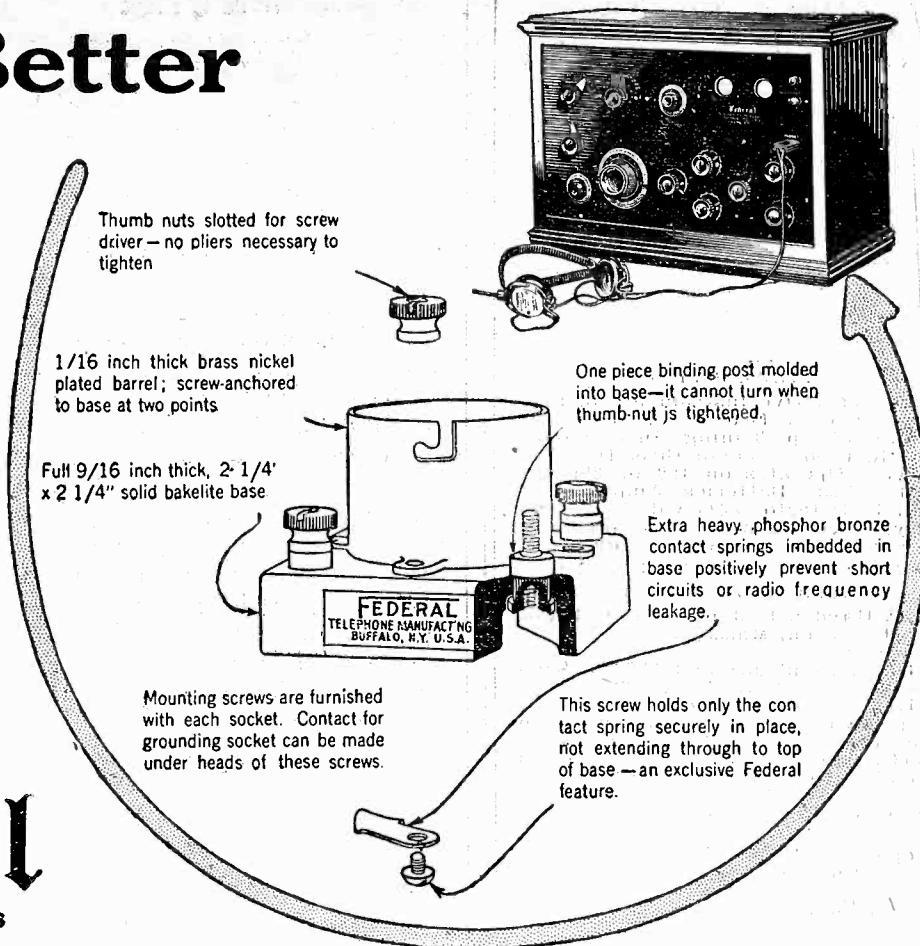

MAGNATRON

MAGNATRON Radio Vacuum Tubes have been improved to that degree of excellence where you can no longer afford to be without them. It will take but one trial to prove to you that MAGNATRONs can put real “pep” in YOUR set.

Recent improvements in manufacture have made the MAGNATRON a superior radio frequency amplifier, a clearer detector, and a louder audio frequency amplifier. Ask your dealer today! He will recommend MAGNATRONs.

Any Type
\$4

Any Type
\$4

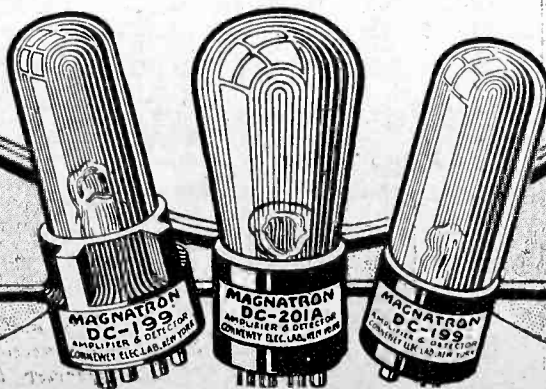

CONNWEY ELECTRIC
LABORATORIES

309 Fifth Avenue
New York City

Tell them that you saw it in RADIO

A. C. H. Three-Tube Concert Receiver

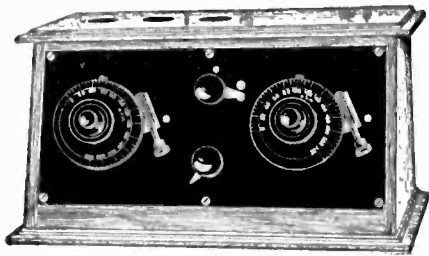

SELECTIVITY

Using sensitive instruments in connection with two A. C. H. Worm Drive Sharp Tuning Instruments. Can be used as one or three tube Receiver. Operates on 199 or 299 dry cell tubes. Batteries Amplifier 90 volt B. Detector 22½ volt B. A battery, three dry cells. C battery, one dry cell. All connections on back.

Installation Plan. No References.

WRITE US AS FOLLOWS:

A. C. Hayden Radio & Research Co., Brockton, Mass.

Gentlemen:

Enclosed please find \$20.00. Send me one A. C. H. Three Tube Receiver. Upon receipt of same I agree to pay you \$1.00 a month for fifteen months until the total amount of \$35.00 is paid. This Receiver is to remain your property until full amount is paid. You guarantee this set to operate on the air.

SIGNED.

Wonderful Value—Limited Production—Mail Orders Only

A. C. Hayden Radio and Research Co.

BROCKTON, MASS., U. S. A.

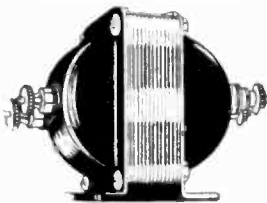

Convince Yourself!

You can now secure the very highest quality

Audio Transformer

of the very latest design, for use in all circuits, for only **\$2.95** postpaid

"Push-Pull" Type

Price, per matched pair, only, postpaid **\$8.50**

Complete information and wiring diagram packed with every Transformer. Satisfaction guaranteed or money refunded.

ASK YOUR DEALER. If he can't supply you, send direct.

Crescent

Transformers

CRESCENT MFG. CO.,
Box 337, Cent. Sta.,
Toledo, Ohio

SUPER-HETERODYNE

Reprints from "RADIO"
By G. M. Best

Sent to any address for 25 cents.
Pacific Radio Pub. Co.
Pacific Bldg., San Francisco, Cal.

A RADIO SET TROUBLE SHOOTER

Continued from page 36

three honey-comb coils and a .0005 mfd. variable condenser, with a .0005 mfd. fixed condenser with cut-in switch. A 0-1 milliammeter in the grid circuit may be used in the study of vacuum tubes.

Coupled to this circuit is another resonant circuit for comparing unknown condenser capacities against a standard known capacity. A comparative indication is given by a galvanometer and flash lamp. Mountings for three honey-comb coils are provided and likewise connections for the unknown condenser. For capacities from .0004 to .006 mfd. 25-turn coils are used. The open circuit jack *J* across coil 1 is provided to receive a microphone plug if coil 1 is to be used as an absorption coil for modulating the high frequency currents generated when testing. The modulating sound is obtained by putting the microphone close to a clock whose ticks give a pleasing sound.

A honey-comb coil mounting, 4, shown in the lower left of Fig. 2 is used to hold a single turn loop which supplies the field to the amplifier and wavemeter circuit shown in Fig. 4. Jack *J*₂, together with a by-pass condenser, is placed in the plate circuit and *J*₃ in the filament circuit of the oscillation. A two-way switch at *S*, puts the oscillator condensers across either the grid or plate circuits to increase the frequency range. An anti-capacity switch is also provided to connect the audio-oscillator coils and condensers.

A rapid and approximate determination of a condenser's capacity may be secured without removing it from the receiving set by plugging a cable into the resonant circuit at *C*, and re-adjust-

ing to resonance after the small pointed contacts at the other end of the cable have been placed across the condensers. The capacity is the total reading of the standard condenser less that of the cable. A more accurate determination may be made by removing the condenser, connecting it into the circuit at *C*₁, and checking against the standard.

The wavelength of the primary and secondary coils may be checked, after the oscillator has been started and the various receiver controls have been set, by inserting the microphone plug into *J*₁, placing the microphone in contact with the clock, and adjusting the oscillator and receiver controls till the clock ticks are the loudest when the headphones are plugged into the output of the receiver under test. This test very quickly shows the best *LC* ratio for set. Of course more accurate tests may be made by removing the coils so as to eliminate errors introduced by the long cords.

The third, or audio frequency, circuit for testing loud speakers and audio transformers is connected by the anti-capacity switch. It is placed as far away as possible from the high frequency oscillation. It consists of from 1,500-turn honey-comb coils with a sliding iron core and of a battery of condensers. It offers a convenient means for checking purity of tone from loud speakers at different audio frequencies.

To test an audio transformer in place by means of this third circuit the speaker plug is placed in *J*₂ and the inductance and capacity is varied to give different audio frequency tones. From these sound indications it is possible to plot an approximate frequency characteristic curve for the transformer under test.

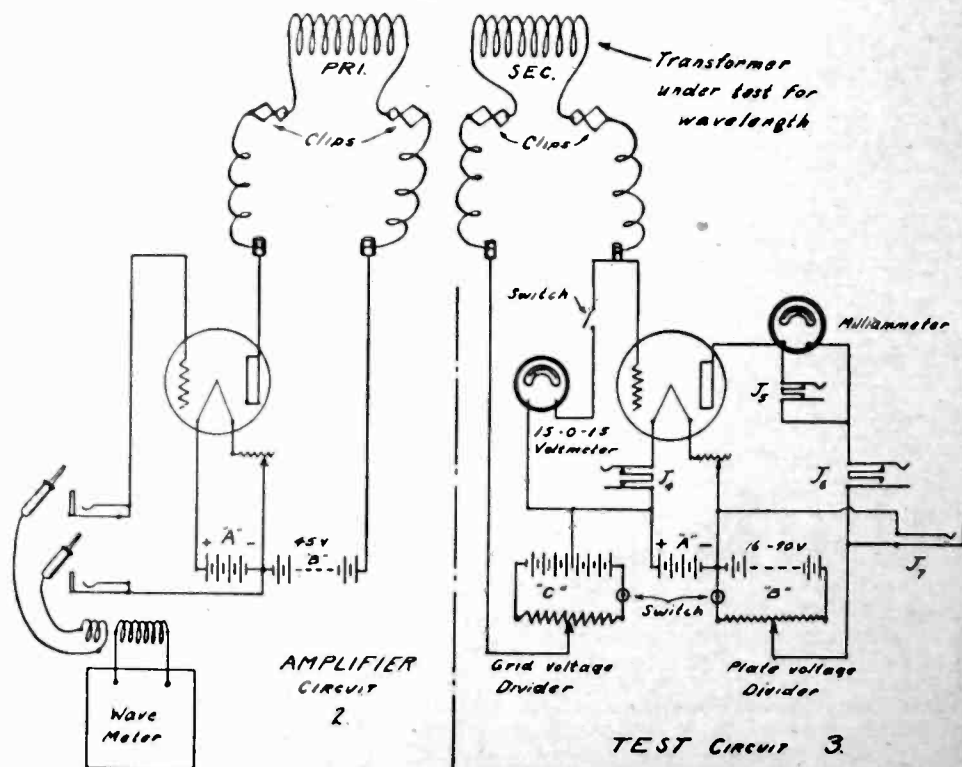

Fig. 4. Amplifier and Wavemeter Circuit Showing Connections for Testing Transformer Wavelength.

TUBES REPAIRING REBUILDING

SAVE ON TUBES!
Buy Direct From Manufacturers!

All Tubes Repaired
(Detectors or Amplifiers)
Guaranteed Like New **\$2.25**

New Amplifon Tubes
Regular \$4 Quality
Introductory price..... **\$2.50**

1 Amp. 6 Volt Tubes Changed to 1/4 Amp. Tubes. Send for Circular on New and Refilled Tubes.

AMERICAN RADIO TUBE WORKS

23 Central Ave. Newark, N. J.

Big Money for Agents Everywhere

Establishing A New Standard

The New and Improved

"Read'em" Binding Posts

"The Knobs Can't Come Off."

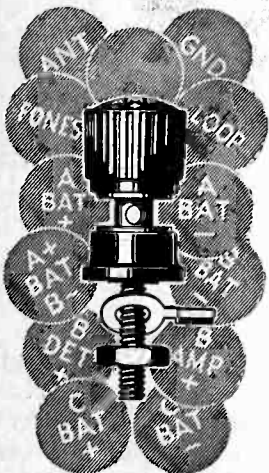

New Markings
Fulfill
Every
Demand

The Utmost
in Quality
and Appearance
at the
Lowest Price

15c

At Your Dealer's or Sent Postpaid

THE MARSHALL-GERKEN CO.

Toledo, Ohio

RADIO Wants You!

Earn \$100 a Week

Radio, the wonderful new growing profession, offers you a glorious opportunity—big money, fascinating work, easy hours, a real future! Wonderful new course prepares you quickly in spare time at home. Famous radio experts help to give you practical work. Instruments supplied free. Write for free book, "Rich Rewards in Radio."

NATIONAL RADIO INSTITUTE,
Dept. 10CB, Washington, D. C.

The fourth, or amplifier circuit, shown in Fig. 4, gives a further means for plotting tube characteristics, transformer wavelength characteristics, and making other tests involving the use of a wavemeter.

The most useful portion of this equipment and that best adapted to portable use is the circuit shown in Fig. 1. It gives position results whereas the other methods are necessarily comparative and dependent upon the accuracy of instruments which are generally found only in a well-equipped radio laboratory.

The complete equipment, in addition to the uses already described, gives a comparative indication of a tube's performance as an oscillator and may also be used in many laboratory research experiments.

RADIO FOR EVERYBODY

by A. C. Lescarbours

Completely re-written and re-illustrated
THE BOOK THAT HAS GROWN WITH RADIO

Tells in plain language how to buy or build your own set. How to install; how to tune in; how to get the best results. Explains all the circuits, vacuum tubes, radio and audio amplification, loud speakers, regeneration, static, and everything else about the subject.

THE ONE BOOK EVERY ENTHUSIAST NEEDS

As Radio develops the story of the new wonders being brought to light will be told month by month in

THE SCIENTIFIC AMERICAN

by the scientists who develop them. Every man and woman who would keep thoroughly posted on the march of progress should read the Scientific American.

HOLIDAY OFFER:

The New RADIO FOR EVERYBODY together with a year's subscription to the SCIENTIFIC AMERICAN for \$5. The New RADIO FOR EVERYBODY together with two subscriptions to the SCIENTIFIC AMERICAN, or with one subscription for two years for \$8.

Two copies of the New RADIO FOR EVERYBODY together with two subscriptions to the Scientific American, or with one subscription for two years for \$9.

Send in the coupon *ow*. This offer is only temporary.

Scientific American Publishing Co.,
Woolworth Building, New York City.
Send me the new RADIO FOR EVERYBODY and the SCIENTIFIC AMERICAN as indicated by my check mark in the box at the bottom of this coupon for which I enclose check.

Name.....
Address.....
Additional Name.....
Address.....
 Radio For Everybody, Scientific American for one year..... \$5
 Two subscriptions to the Scientific American..... \$8
 Two copies of Radio for Everybody, Two subscriptions to the Scientific American..... \$9

RADIO MAPS

35c

PACIFIC RADIO PUB. CO.

Pacific Bldg. San Francisco, Calif.

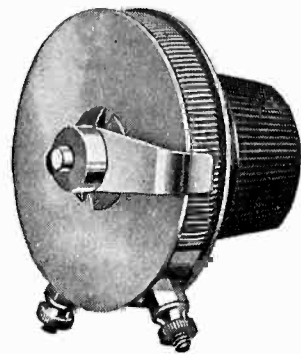

A new RHEOSTAT

with immovable coils

The coils of the new Centralab Rheostat are firmly clamped between and imbedded in insulating material so they cannot move. This eliminates the noise in the set caused by lateral movement of coils. It also maintains a uniform spacing between windings, giving smooth, even regulation and eliminating dead spots.

The contact arm is sturdy and positively locked to the shaft. The contact shoe passes over the resistor at a tangent and cannot catch. Attractive in appearance, and substantial in construction. All metal parts except wires are of brass, heavily nickel plated. The knob may be adjusted flush with the panel or replaced by any standard dial. Single hole mounting.

No. 206—6 ohms maximum resistance, \$1.25
No. 230—30 ohms maximum resistance, 1.25

We also manufacture the

Centralab Adjustable Grid Leak No. 106—\$1.25 No. 107—(with .00025 con- denser), \$1.60	Centralab Battery Switch No. 300— 50c	Centralab Non-Inductive Potentiometer No. 110—400 ohms, \$1.50 No. 111—2000 ohms, \$1.75
--	--	---

TO JOBBERS AND DEALERS: The trade mark of products of the Central Radio Laboratories has been changed from CRL to Centralab. Write for literature.

Centralab

CENTRAL RADIO LABORATORIES
295 Sixteenth St. Milwaukee, Wis.

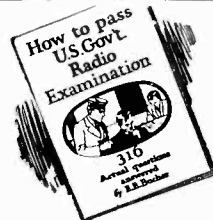

How to Pass U. S. Gov't. Radio License Examination

By E. E. Bucher

Of inestimable value to those desiring Commercial or Amateur Radio License. Covers transmitters, receivers, storage batteries, motors and generators, radio rules and regulations. 316 actual questions answered! Written by a radio expert, author of Practical Wireless Telegraphy, etc. Over 150,000 copies sold. Send 50 cents in stamps or coin for your copy, postage prepaid to any point in the U. S., Canada or Mexico.

RADIO INSTITUTE OF AMERICA
322 Broadway New York City



Of Course It's
a CROSLEY
 Better—Costs Less
 Radio

*Crosley
 Head Phones
 Better—Cost Less
 \$3.75*

“OH, BOY! There's the West Coast! Last night I had the East Coast, and the night before that, Havana. I bet I get London soon. This Crosley sure does bring 'em in. I can tune out local stations any old time and get what I want. There's nothing like a Crosley!”

That's what thousands of men, women and boys are finding out every evening in all parts of the United States. So enthusiastic are they that hundreds of voluntary letters tell us daily of the really remarkable performances of Crosley Radios and the complete satisfaction that they give.

THE CROSLEY RADIO CORPORATION

119 Sassafras Street,

Powel Crosley, Jr., President

Cincinnati, Ohio

Crosley Owns and Operates Broadcasting Station WLW

Here is what a few users of Crosley Instruments say:

Parkersburg, W. Va., Sept. 30, 1924.
"Wish to congratulate you on the one-tube Crosley 50. Have listened to Havana, Cuba, and as far west as Oakland, Los Angeles and San Francisco. This is what I call a wonderful set."

Rockville, Md., Oct. 1, 1924.
"I thought it would interest you to know that on September 15th, I received Oakland, California, on my two-tube Crosley 51. That station is 2,434 miles from here. I had a hard time making my friends believe it until I wrote to California and had them verify what I heard. As soon as I can afford it, I expect to get a Trirdyn."

Olney, Ill., Oct. 15, 1924.
"I'm getting stations from New York to Seattle, Wash., on my Trirdyn. Monday night, October 13th, I received clearly and plainly the announcer and music from Honolulu, Hawaiian Islands, 7,000 miles away. My machine is not for sale."

Names upon request



**Crosley One Tube
Model 50, \$14.50**
With tube and Crosley Phones \$22.25



Crosley Two Tube Model 51, \$18.50
With tubes and Crosley Phones \$30.25

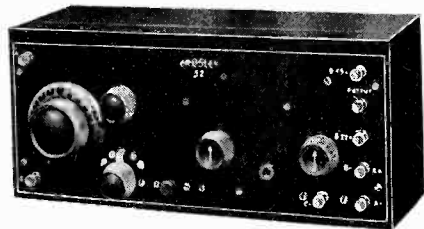

Crosley Three Tube Model 52, \$30.00
With tubes and Crosley Phones \$45.75



Crosley Trirdyn Regular, \$65.00
With tubes and Crosley Phones \$80.75



Crosley Trirdyn Special, \$75.00
With tubes and Crosley Phones \$90.75

**BEFORE YOU BUY — COMPARE
YOUR CHOICE WILL BE
A CROSLEY**

For Sale by Good Dealers Everywhere
Write for Complete Catalog

THE CROSLEY RADIO CORPORATION

Powel Crosley, Jr., President

119 Sassafras St., Cincinnati, O.
Crosley Owns and Operates Broadcasting Station WLV

Crosley Regenerative Receivers are Licensed under Armstrong U. S. Patent 1,113,149

Prices West of the Rockies add 10 per cent.

**Mail
This
Coupon
At Once**

The Crosley
Radio Corp'n.
119 Sassafras St.
Cincinnati, O.
Mail me, free of
charge, your catalog
of Crosley receivers
and parts.

Name _____

Address _____

Duo-Spiral Folding Loop

Price
\$8.50

Increases
Selectivity

Reduces
Static

Easily
Portable

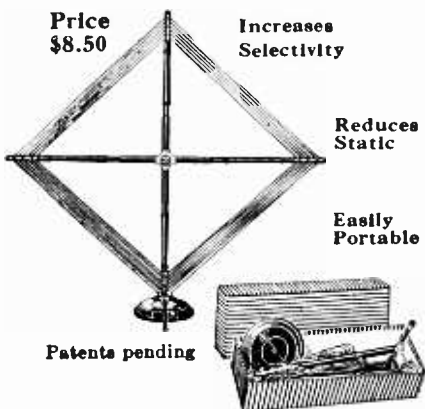

Patents pending

The favorite loop aerial because of its great convenience, handsome appearance and superior performance. Brings in the distant stations with remarkable volume. Fine for permanent installations or portable sets.

Rotates on base which has silvered dial graduated for calibration. Handle permits adjustment without body capacity effects. Standard loop for super-heterodyne. Adopted by leading manufacturers of complete sets. Handsomely finished in silver and mahogany.

Duo-Spiral is made by the manufacturers of Tiny-Turn, the superior vernier control which makes perfect tuning easy. If your dealer is unable to supply either of these standard products, write us direct.

Radio Units Inc.

1303 First Avenue

Maywood, Ill.
Perkins Electric, Ltd., Montreal

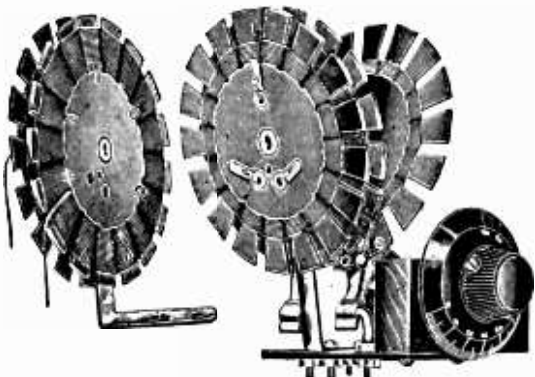

ROBERTS UNITS

(Trade Mark)

THE WONDER CIRCUIT OF THE YEAR

Combining Neutralization—Regeneration—Reflex Developed by Walter Van B. Roberts, E.E., Ph. D. Editorially Endorsed by Radio Broadcast, as Without Doubt The Best We Have Ever Seen

California Actually Heard at Princeton University On The Loud Speaker, WITH TWO TUBES.

ROBERTS UNITS consist of Five Coils in Two Mountings Ready for Installation. Packed complete with all instructions. Hook-up, Schematic Print, Cut of Complete Set, etc. BUILD A ROBERTS

AND REACH THE COAST
Coils Mfg. under Zig-Zig
Pat. Aug. 21, 1923.

\$8.00

ROBERTS KIT

(Trade Mark)

Complete Kit of High-Grade Parts for the ROBERTS TWO TUBE KNOCKOUT SET

Genuine Bakelite Panel, completely drilled. General Radio Condensers, F. M. C. Transformer, Sockets, Condensers, Genuine Roberts Units, Baseboard, Dials, Knobs, Busbar, Spaghetti—Everything, except Tubes, Batteries, Cabinet,

with Portena
\$60 Folding (Loop for Local Use)

Without Loop
\$53

J. NAZELEY COMPANY, Dept. B
571 Hudson St. (Sole Mfgs.) New York
Western Representatives
BAKER SMITH CO.
741 Call Building San Francisco

CALLS HEARD

Continued from page 94

By 7UB, Perry Wonnacott, 536 Liberty Street, Silverton, Ore.

175 to 200 meters, 40ft, 5ado, 5afx, 5ft, 5hg, 5lh, 5rx, 5ab, 5acz, 5afo, 5agn, 5all, 5ais, 5akr, 5amf, 5aoh, 5aon, 5atn, 5bbq, 5ben, 5bcs, 5bct, 5bdf, 5bes, 5bgb, 5bh, 5bht, 5bku, 5bkv, 5bct, 5bge, 5bcg, 5bdy, 5bcv, 5bco, 5brv, 5cso, 5csw, 5cjjw, 5ct, 5ctm, 5cuo, 5edi, 5fg, 5il, 5kt, 5lu, 5mf, 5qh, 5ql, 5pu, 5rf, 5sp, 5vf, 5vo, 5vr, 5ws, 5xi, 5bcb, 5blr, 5cfs, 5czy, 5dal, 5aav, 5amb, 5amf, 5amp, 5aob, 5aoj, 5asd, 5avv, 5aws, 5aci, 5bfa, 5bfy, 5bha, 5bkt, 5bjj, 5buf, 5bzy, 5cch, 5cde, 5ce, 5cht, 5cid, 5cpd, 5cvn, 5cyd, 5day, 5dch, 5deb, 5dge, 5dpc, 5dyx, 5eam, 5efc, 5ejn, 5emk, 5su, 5zt, 5wo.
Canada—4av, 5ah, 5as, 5ba, 5cp, 5ct, 5os, 5hk.

All cards answered.

By UGAR, C. E. Duncan, 3029 Acton Street, Berkeley, Calif., U. S. A.

(1aw), (1da), (1gv), (1lw), (1ow), (1pl), (1sf), (1tb), (1aa), (1aa), (1abf), (1ajw), (1are), (1aww), (1bds), (1bgq), (1bkq), (1bsd), (1cmp), (1zt), (1xav), (2by), (2dn), (2ku), (2rk), (2mu), (2ud), (2wr), (2xq), (2brb), (2cgo), (2chg), (2cvu), (2czq), (3bh), (3ot), (3adp), (3ava), (3bhv), (3chg), (4lo), (4jr), (4ku), (4oa), (4qf), (4sl), (4tj), (5ac), (5dw), (5ek), (5ew), (5hl), (5ml), (5ox), (5uk), (5az), (5ajj), (5agl), (5ail), (5zal), (5zp), (7abb), (8gz), (8pl), (8rv), (8zq), (8zk), (8ada), (8aro), (8bau), (8brq), (8cy), (8cx), (8do), (8adq), (8ags), (8aim), (8amx), (8aol), (8azr), (8xi), (8bcj), (8bfq), (8buk), (8cee), (8cfl), (8cjc), (8cpm), (8ddp), (8dev), (8dpx), (8egu), (8eht), (8ebh), (8eky), (8eld), (8fv).

Australian—2me.
Argentine—9tc.
Canadian—(1ar), (2cg), (3 bp), (3nl), (4cr), (5an), (5ba).

Mexican—(bx), (lb).
New Zealand—2ac, (4aa), (4ak), (4ag).
All districts worked in one night, 12 times during November. All above work done around 80 meters with a Reinartz lo-loss receiver and a 250 watt bottle for the transmitter. 6arb, qsl's.

By John H.-P. Andrews, cor. Lake and Bellona Aves., Baltimore, Md.

(Only 1 tube, 1 hour a night, 1 month, 3 circuit.)

4bw, 4cl, 4cs, 4eq, 4fz, 4io, 4jr, 4ke, 4ku, 4mb, 4ml, 4nj, 4pv, 4qy, 4rr, 4sa, 4sb, 4sl, 4xau, 4xx, 5aaq, 5aax, 5ac, 5adh, 5aex, 5afu, 5agj, 5ags, 5ahd, 5air, 5aiu, 5aju, 5alr, 5am, 5ame, 5apc, 5arl, 5dw, 5ek, 5gf, 5gk, 5hu, 5jf, 5lh, 5lu, 5ml, 5nw, 5ot, 5ox, 5ph, 5ql, 5rh, 5rl, 5sd, 5se, 5uj, 5uk, 5uv, 5xau, 5zav, 5ac, 5adt, 5agk, 5anh, 5aj, 5ajf, 5ajh, 5alb, 5alk, 5ame, 5ao, 5apw, 5arb, 5ase, 5avr, 5awt, 5bcr, 5bde, 5bdt, 5bez, 5bjj, 5bjx, 5blw, 5bny, 5bqa, 5bra, 5buf, 5buh, 5bur, 5caq, 5cax, 5cgg, 5cgo, 5cgs, 5cig, 5cix, 5cjj, 5cjp, 5cms, 5cmu, 5cnl, 5csc, 5ea, 5eb, 5eg, 5gt, 5lj, 5of, 5rm, 5ut, 5vc, 5vo, 5wl, 5ww, 5wt, 5xl, 5yh, 5zp, 7abb, 7acm, 7afn, 7af, 7am, 7bj, 7dd, 7fd, 7gr, 7jq, 7lq, 7mf, 7ot, 7zz, 9aey, 9alo, 9aiu, 9aod, 9aor, 9axf, 9axt, 9axx, 9ay, 9ays, 9bcd, 9bcj, 9bfg, 9bfl, 9bfm, 9bga, 9bgh, 9bht, 9bhx, 9bie, 9blq, 9bje, 9bjl, 9bkr, 9bm, 9bm, 9bmv, 9bmx, 9bmy, 9bnf, 9bnk, 9bqa, 9btd, 9buh, 9buk, 9cap, 9ccm, 9ccv, 9cdv, 9cee, 9cfj, 9cfr, 9chc, 9cia, 9cip, 9ciu, 9cjc, 9ckb, 9clj, 9clq, 9clx, 9clz, 9cmg, 9cmx, 9cov, 9cp, 9cpm, 9cbr, 9cv, 9cvs, 9cxx, 9cyd, 9cyy, 9czv, 9db, 9dbp, 9dct, 9ddf, 9ddp, 9ded, 9deu, 9dev, 9dfh, 9dfq, 9dfv, 9dgv, 9dhq, 9dkt, 9dlm, 9dms, 9dng, 9dp, 9dpl, 9dpo, 9dpx, 9dyt, 9eas, 9ebh, 9efh, 9efj, 9efz, 9egh, 9egu, 9ehs, 9eht, 9ehy, 9ej, 9ejy, 9ek, 9eky, 9elb, 9eld, 9ell, 9es, 9fm, 9hn, 9in, 9jc, 9mf, 9mn, 9ny, 9oa, 9of, 9ql, 9qw, 9tg, 9ti, 9vz, 9xay, 9xbp, 9xi, 9yb, 9yx, 9zd.

Canadian: 1ar, 1dq, 2qh, 3aa, 3ac, 3bg, 3ly, 3tr, 3zt, 4cr, 5go; also nkf, nfv, wgh.
French: 8ab, 8go.

By 9CZV, Chicago, Ill.

1aac, 1abf, 1abs, (1acb), (1aaa), 1ajx, 1ana, (1asu), 1atj, 1aur, 1avw, 1bcc, 1bcu, 1bge, (1bhn), (1bvb), (1cab), 1dd, 1ke, (1py), 1rp, 1vj, 1xak, 1xam, (2aan), (2ag), 2agw, (2anm), 2aqh, 2awf, (2bbn), 2bm, 2bpb, 2bqc, 2bqw, 2cbg, (2cjj), 2cpa, 2cpk, 2cty, 2cvj, 2cvs, 2cvu, 2cza, (2czq), (2czt), (2dn), 2kf, 2ku, 2qh, 3aay, 3adb, 3alx, 3aj, (3auv), 3bc, (3bd), (3bfe), (3bfu), 3QA?, 3bhv, 3bmn, 3ccx, (3cdg), 3cdn, 3chc, 3chg, 3cjn, 3eh, 3hh, 3hs, 3ju, 3jw, 3lg, (3ll), (3oq), (3ot), (3qt), (3wb), (3wn), 3zw, (4ai), (4bj), 4cs, 4eh, 4eq, 4fs, 4io, 4jr, 4ku, 4ml, 4tj, 4uk, 4xe, (5ac), (5agn), 5ags, 5ajj, 5alu, 5ajj, (5am), 5amh, 5aqw, 5arl, (5ek), 5lu, 5nw, 5se, 5zav, 5afg, 5alo, 5bjx, 5bqr, 5buh, 5bur, 5bw, 5cfz, 5chl, 5cjj, 5cks, 5cnl, 5gg, 5lj, 5xl, 7abb, 7ag, 7gb, 7ij, 7jq, 7mp, (8aju), (8aly), (8bpa), (8coj), (8cta), (8dgp), (8dpm), (8kc), (8up), (8wo), (8zg), (9amx), (9dfz), (9vz), (9xi).

AMPLEX

GRID-DENSER

You won't believe what an Amplex GRID-DENSER can do for your set until you actually try one

ANY circuit—Super-Heterodyne, Four Circuit Tuner, Neutrodyne—GRID DENSER will improve it.

Follow the lead of radio men like Best, Cockaday, Haynes and many others. Replace all your fixed condensers with GRID DENSTERS and get Greater Distance, Louder and Clearer Signals

In either the .0005 with or \$1.25 without gridleak clips or 001 type or type N (neutralizing)

Free Ask your dealer for the FREE Hook-up Booklet, "How to Double the Efficiency of your Set."

AMPLEX INSTRUMENT LABS.
88 W. B'way, New York N. Y.
Dept. R. P.

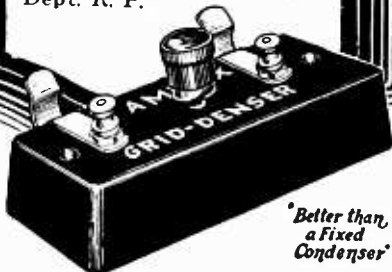

Better than a Fixed Condenser

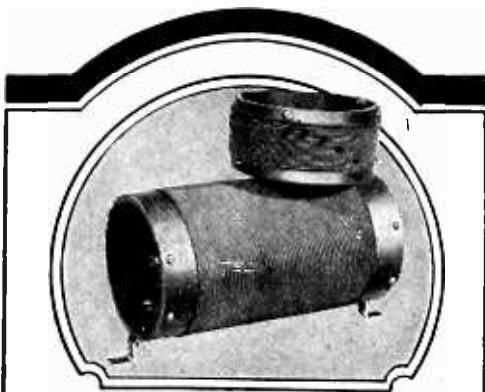

The Authorized Cockaday Coil \$5.50

Specified in Oct. Popular Radio as Cockaday Precision Coil

The only coil specified by Mr. Cockaday in his New Four Circuit Tuner, with resistance coupled amplification because it meets all his specifications.

The only authorized Cockaday Coil, made in strict accordance with specifications of Laurence M. Cockaday, inventor of the famous Cockaday Four Circuit Tuner. Wound on hard rubber tubing 1/4 inch wall, with No. 18 D. S. C. copper wire which insured selectivity, greater volume, sharp tuning and maximum sensitivity. Guaranteed.

Gets distant stations easily and clearly. Hundreds have substituted this quality coil for those of inferior make and are amazed at the improved reception, selectivity and general D-X results.

At your dealers, otherwise send purchase price and you will be supplied postpaid. In Canada, \$7.75. Canadian Distributor—PERKINS, Ltd., Montreal.

Approved by

L. M. Cockaday

PRECISION COIL CO., INC.

209-C Centre St.,
New York

At 9DNG, Fergus McKeever, Lawrence, Kansas

1aar, (1abf), 1abl, (1abp), 1aqf, 1acb, 1aco, 1ael, 1aid, 1ajx, 1ato, 1akz, (1als), 1anr, 1abs, (1aqm), 1ard, (1are), (1ary), (1atz), 1avp, 1avw, 1avx, (1awe), 1axa, 1ayk, (1alk), 1aa, 1ajo, 1bbe, 1bhh, (1bcc), 1bcu, 1bec, 1bgc, (1bhm), 1bj, (1bjo), 1bkk, 1bob, 1bot, 1bsd, (1bvb), 1bvl, 1cb, 1ckp, (1cme), 1cmy, (1cru), 1da, (1ef), (1ez), (1fg), 1fm, (1agk), (1ga), 1il, 1il, (1iv), 1bc, 1kc, 1lw, (1gw), 1my, 1py, 1qp, 1qm, 1sd, 1sw, 1sz, 1vf, 1vj, (1xam), 1xw, 1fb, 2aa, (2abo), (2abr), 2acs, (2ach), 2ad, (2af), (2agq), 2ais, 2ajq, (2anm), (2aoy), 2agw, 2bbn, 2bjo, 2bqb, 2bqn, (2brb), 2bse, (2bbx), 2buy, (2cee), 2cei, (2cgb), (2cgl), (2cjj), (2cix), (2cpa), 2cgo, 2erp, 2cth, 2cty, 2cu, (2cix), (2cyx), (2chz), 2czq, (2czr), (2eq), (2cvj), (2cyx), (2chz), 2id, 2li, 2mc, 2mu, (2pd), (2qs), 2rk, (2sy), 2sz, 2wr, 2wz, 2ud, 2xq, 3abw, (3acf), (3ade), (3adv), (3aih), 3als, 3arp, 3auv, 3acy, (3baq), 3bbs, 3bdo, 3bco, 3bfe, (3bgg), (3blc), 3bjp, 3bmt, (3bob), 3bu, 3cbc, (3cdg), (3cdn), 3cdq, (3ccu), (3cgs), 3chk, 3chg, 3che, 3cjj, (3ckh), (3ckl), (3bvk), 3el, (3cdk), 3kd, 3mf, (3ma), 3ni, 3og, 3oq, (3qt), (3tp), 3sl, (3wb), 3xx, 4bq, 4ai, 4ch, 4cl, (4du), 4dv, 4dy, 4eq, 4ez, 4fz, 4gw, 4io, 4is, 4jr, 4js, 4jx, 4jk, (4mb), 4mi, 4oa, 4pl, (4pd), 4pk, 4qf, 4qy, 4rr, 4tj, 4uf, (4ux), 4si, 4sa, 4xe, 6aan, 6aaq, (6adb), 6adm, 6afh, 6ahp, 6aiu, 6awt, 6aji, (6ahp), 6ake, 6alo, (6ano), (6ame), (6amm), (6aww), (6ARX), 6agk, 6bbv, 6bcd, (6bd), (6aww), (6ARX), 6agk, 6bbv, 6bcd, (6bd), 6bey, 6bf, 6bgc, 6bgn, 6bfw, 6bir, 6bjj, 6blx, 6bka, 6bnk, (6bm), (6beb), 6bon, 6bny, (6bql), (6cae), 6can, 6cdc, (6cdg), (6ech), 6cgo, 6cgw, 6chl, (6cje), (6clp), 6civ, 6cmi, 6cmu, 6cni, 6cqe, 6cp, 6cti, 6cto, 6crx, 6css, 6csw, (6cuf), 6eb, 6gg, 6gt, 6bf, (6ih), (6ji), (6jp), 6amo, 6ahw, 6ne, (6oi), 6pl, 6rm, (6ti), (6uf), 6vw, 6wi, (6wt), (6zp), 7abb, 7afm, (7af), 7aru, 7au, (7akk), 7ca, 7dd, (7df), 7fd, 7fr, (7gm), (7gv), 7gb, 7gr, 7ij, 7iu, 7jq, 7ge, 7ku, 7lq, 7ls, (7mf), 7mp, 7ok, 7ot, 7oy, 7pm, 7sb, 7ry, 7zq, 7zx, (ncg), nkf, nse, kdef, 1px, zrn, g2kf, (Mexican BX), 1b, 1e, R9tc, Z4aa, Z4ak, Z4ag, Z2ac.
Canadian: 1ar, 2cg, 2bf, 2kc, (2bv), (3ly), 3ka, (3ms), 3mv, 3xi, 3gv, (4av), 4aw, (4cb), (4dq), 4ae, (4fv), (4fz), (4gh), (4gt), (4hh), (4aa), (5as), 5an, 5bf, 5ba, (5go), (5hs).
Wud certainly appreciate reports on my sigs.

CARDWELL

THE ORIGINAL LOW LOSS ROTOR-GROUNDED CONDENSER

The CARDWELL is the original low loss rotor grounded condenser, and to this day it is without a peer. The leading radio engineers and technical editors still recognize the CARDWELL as the ONE BEST. Scientifically designed in the beginning, it has not been necessary to change the CARDWELL in any material way to maintain its undisputed superiority.

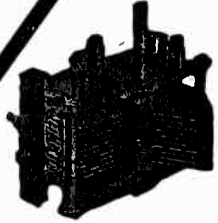

See the CARDWELL at all dealers.
A post card to us will bring you an education on condensers.

Allen D. Cardwell Mfg. Corp.
81 Prospect Street Brooklyn, N. Y.

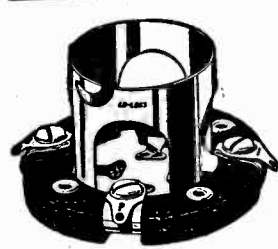

PREMIER
"LO LOSS"
TUBE
SOCKET
90 Cents
All Types

STRENGTHEN YOUR SPEAKER VOLUME

Conserve the current at full strength and strengthen your speaker volume with this radically different socket. Has the lowest insulation leakage to radio frequency current. Bakelite between terminals is purposely thin, and all metallic parts are placed so as to reduce capacity between them and the terminals to the very minimum.
Contact springs in the "LO LOSS" are in one piece from binding post to tip of tube. The skeleton tube barrel permits inspection of contact at prong tips while tube is in socket. The contact springs automatically clean the tube prongs as the tube is inserted, insuring good contact always. The new tube lock with the cam action makes the proper insertion of the tube easy. A twist of the wrist does it. The terminals are curved and will stand unusual deflection without setting.
Write for Free Bulletin No. 94, showing complete line of Premier Quality Radio Parts. Ask your dealer if he has Premier free hook-ups. If not, send his name and receive a set free.

Premier Electric Company
PREMIER
Quality Radio Parts
8513 Ravenswood Avenue CHICAGO

Model A
2400
Ohms
\$4.00
LIST
Model B
3000
Ohms
\$5.00
LIST



'Single Pole'

Guarantees Matchless Reproduction
From all parts of critical America, from wireless workers, amateurs, and from those who just insist upon the best, comes enthusiastic indorsement for Repeater Phones. Distance is annihilated, obstacles vanquished by Repeater.

This matchless tone quality is due chiefly to the 'Single Pole' feature, exclusive with Repeater.

All the power of the air unleashed flows evenly, smoothly through Repeater's 'Single Pole'—you are certain of exact, faithful reproduction.

ASK FOR

our illustrated booklet containing complete details.

DEALERS

In Repeaters you will find a popular appeal. Our discounts will interest you. Write for Merchandising Plan.

The New Improved "Repeater"

Moss-Schury Mfg. Co., Inc.
Radio Division
2009 Franklin St., Detroit, U. S. A.

TURNABOUT PEDESTALS FOR
Radiola Super-Heterodyne
and other directional receiving sets. Permits your set to revolve freely upon a mahogany-finished base.
Sent postpaid upon receipt of \$1 Special quantity prices to dealers.
LEVINSON RADIO LABORATORIES
58 Collins Street, San Francisco, Calif.

GLOBE LOW-LOSS TUNERS

Loses Nothing
Tunes every Radio
impulse the aerial
receives.

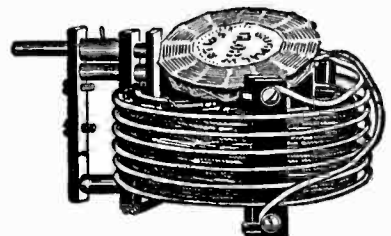

Patent Applied For
No Meta Large Wire
No Eddy Current Losses Self Supporting

Little Insulation Anti-capacity Windings
Low Distributed Capacity Low R F Resistance

GET ORIGINAL GLOBE COILS
Standard Tuner (Broadcast Range) \$7.00
Short Wave (35-135 Meters) \$7.00
For Superdyne Circuit \$8.50
R F Transformers \$6.00
Circular on Request. Dealers and Jobbers Write.

SEND ORDERS DIRECT TO
Globe Radio Equipment Co.
217 West 125th St., N. Y. C.
Imitation is Deceit *Legal Action Pending

VOLT-X VARIABLE GRID LEAK

Give Your Tubes a Chance

The Grid Leak determines the efficiency of your set. The proper Grid resistance varies for each tube, and the conditions under which it operates.

VOLT-X GRID LEAKS are positive and smooth in action with an accurate range of from 1/2 to 15 meg-ohms. They fit any standard leak mounting, and get the absolute maximum from your tubes.
Grid Leak \$1.00
Grid Leak Mounting .30



BURTON & ROGERS
MFG. CO.
755 BOYLSTON ST., BOSTON, MASS.

Tell them that you saw it in RADIO

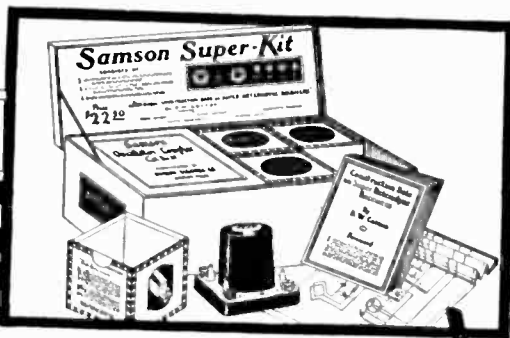

Samson Super-Kit

Another Radio Achievement

- KIT INCLUDES
- 3 Samson Long Wave Transformers
5000 meter wave length
 - 1 Samson Filter Transformer
for this wave length
 - 1 Samson Oscillator Coupler

Also full information on how to
Build This Set

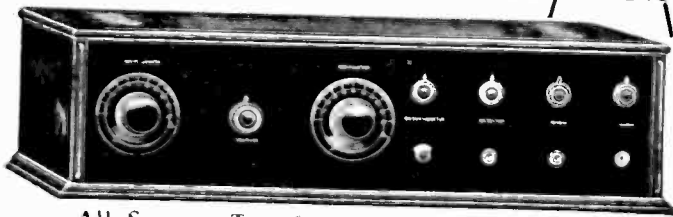

All Samson Transformers are made with the
FAMOUS HELICAL WINDINGS

Remember that "Samson" stands for 42 years of leadership in the
manufacturing of electrical specialties. Other
Samson Radio products:

SAMSON		SAMSON	
AUDIO TRANSFORMERS		PUSH-PULL TRANSFORMERS	
HWA2	6-1	HWA2-I	Input
HWA2	3-1	HWA2-T	Output

REPRESENTATIVES:

SAN FRANCISCO, A. S. Lindstrom,
274 Brannan St.
LOS ANGELES, Lombard J. Smith,
324 North San Pedro St.

PORTLAND, H. A. Killam,
140 1/2 North Tenth St.
SEATTLE, G. H. Maitre,
95 Connecticut St.

Samson Electric Co. Canton, Mass.
Write for proof of Samson superiority

Meter Repairs

on Radio and Electric Meters, such as
General Radio, Jewell, Roller Smith,
Brown, etc. in fact any kind, any make,
under guarantee and at reasonable cost.
FARRIG ELECTRIC WORKS
182 Fourth Street, San Francisco, Calif.
Phone Garfield 1548

"Bruno" Ultra Vario Condenser

LOW-LOSS
Originated Multiple Tuning
3 in 1—.0005, .00025, .000125 mf. \$5.50
5 in 1—(4 sections) from .0001 to .001
mf. \$7.50
BRUNO RADIO CORP., New York
A. S. Lindstrom, San Francisco, California

Two Feature Articles

On SUPER HETERODYNE
Receiver Construction will be
published in

February "RADIO"

Subscribe now to insure get-
ting your copy.

\$1.00 Brings "RADIO"
for Six Months

By 6BJX-6CVE, E. O. Knoch, 2823 E. 6th
St., Los Angeles, Calif.

Short Waves: 1abf, 1abq, 1bhn, 1bkr,
(1bsd), 1er, 1fd, 1gv, 1il, (1kc), (1my),
(1sf), 1xam, 1xav, 1xw, 1xz, (1zt), (2aay),
2abn, 2anm, 2brb, 2bsc, 2byw, 2cej, 2cjj,
2cjr, 2cqz, 2cra, 2cvj, 2gk, (2mu), 2pl,
(3alh), 3bdo, 3bfe, 3bg, 3bhv, (3bhw),
3bwj, 3bz, 3cdg, 3che, 3cjn, 3hh, (3og),
3wb, 4fs, 4fz, 4lo, (4jr), 4ku, 4my, 4oa,
4qf, 4rr, (4sa-Porto Rico), 4tj, 4uk, 4xe,
4zd, 5aal, 5aaq, 5acl, 5ad, 5aec, 5aef, 5aex,
5afn, 5agl, 5ags, (5aj), 5ail, (5aiu), 5ajb,
(5ajh), 5ajj, (5am), (5ame), (5amg), 5amu,
5amw, 5sa, (5be), 5cn, 5dw, (5gk), 5hl,
5ln, 5jf, 5ka, 5li, 5ml, 5nw, 5oq, 5ot, (5ov),
5ow, 5ox, (5ph), (5pv), 5qy, 5rh, 5se, (5uj),
5uk, 5wy, 5xat, 5za, 5zas, 5zav, 7abb, 7acl,
7ain, 7ahl, 7ajy, 7alp, 7akh, 7akk, (7bj),
7cw, 7dy, 7fd, (7fq), 7fr, (7gb), 7gd, 7gk,
7gm, 7gq, (7gr), 7lj, 7lw, 7lx, 7jq, 7ku, 7lq,
(7ls), (7ly), 7mf, 7mg, 7mp, 7mv, 7ob,
(7oy), 7ot, 7qd, 7rh, 7rk, 7to, 7zm, 8abm,
8ada, 8aev, 8ah, 8aju, 8amr, 8atp, 8ayu,
(8bau), 8bit, 8bql, (8bpa), 8bte, 8bwa,
8byn, 8cbp, 8cel, 8cfp, 8cml, 8cxp, 8cyl,
8dgp, 8dhu, 8dhw, 8doo, 8dqf, (8gz), (8kc),
8pl, 8up, (8wo), 8ze, 8zg, 8zy, 8zz, (9abf),
9aey, 9aim, 9aol, 9aud, (9axs), 9bcj, (9bdu),
9bdw, 9bfg, 9bht, 9bhx, 9ble, 9bje, (9bjl),
(9bm), 9bmr, 9bnu, 9bmx, 9bnk, 9brx, 9bvz,
2bzig, 9cap, (9cbf), 9ccx, 9cdv, 9cca, 9cf,
(9efy), 9eii, 9cip, 9cjc, 9cjs, (9cju), 9cjl,
9eld, 9elj, 9clq, 9cov, (9ctr), 9cvo, 9cva,
(9cxa), 9cyk, 9dbp, 9ddp, (9ded), 9dfh,
9dfq, 9dfz, 9dix, 9dlr, 9dmj, 9dms, 9dpx,
9dqu, (9dxn), 9dyt, 9eak, 9efg, 9efh, 9efo,
9efm, 9efy, 9egh, 9egu, 9egz, 9eht, 9el,
9ek, 9ekf, 9eky, 9en, 9ih, (9hk), (9hn),
(9jc), 9nv, 9ny, 9rd, 9yb, 9xi, (9zb), 9zd
(9zt).

Canadian: 4cr, 5an, 5gf, 5go.

New Zealand: (2ac), 4aa, (4ag), 4ak.

Others: (nfv), nkf, wgh.

By Albert E. Searlett, Jr., 23 Cooley Place,
Mount Vernon, N. Y.

1alk, 1ary, 1bhr, 1bni, 1bub, 1cru, 1cx,
1ef, 1ga, 1hb, 4al 4bq, 4ch, 4cl, 4du, 4eh,
4fs, 4io, 4jf, 4jr, 4ke, 4ku, 4nu, 4oa, 4pl,
4qy, 4rr, 4sb, 4sl, 4su, 4tj, 4tn, 4uk, 4ux,
4xe, 5aaq, 5aaz, 5abn, 5ac, 5acl, 5aef, 5agl,
5agq, 5ags, 5ail, 5ajb, 5ajh, 5alj, 5alz, 5ame,
5aom, 5ap, 5aqy, 5cn, 5cv, 5dm, 5fk, 5gk,
5in, 5jf, 5ka, 5kc, 5li, 5lu, 5ml, 5mz, 5nm,
5nw, 5ov, 5ox, 5ph, 5qy, 5rg, 5rh, 5se,
5uj, 5uk, 5za, 6adt, 6age, 6ahp, 6ajl, 6akw,
6alo, 6ao, 6aob, 6arb, 6arx, 6aws, 6awt,
6ber, 6bdt, 6blw, 6bm, 6bon, 6bql, 6bur,
6cdn, 6eel, 6ego, 6chl, 6cix, 6cmi, 6cms,
6cmu, 6cnl, 6cto, 6cw, 6ea, 6gt, 6lj, 6ol,
6qs, 6rm, 6rn, 6zp, 7afn, 7gr, 7kr, 8amb,
8ada, 8add, 8aes, 8afn, 8afq, 8afs, 8ago,
8ajn, 8ajc, 8ajz, 8alf, 8aly, 8amr, 8anb,
8apo, 8arb, 8art, 8ase, 8atz, 8aua, 8avj,
8awe, 8awj, 8ayu, 8bau, 8bec, 8ber, 8ben,
8bge, 8bgn, 8bhj, 8bit, 8blg, 8blp, 8bml,
8bnh, 8bni, 8boq, 8boy, 8bpa, 8bpl, 8bpv,
8bqa, 8bqr, 8brc, 8btu, 8btv, 8buk, 8bxp,
8bxt, 8bxv, 8byb, 8byt, 8caz, 8cbm, 8cbp,
8eel, 8eer, 8eed, 8ejk, 8cjp, 8cic, 8coj, 8eow,
8cpk, 8eql, 8ese, 8etz, 8cyl, 8cvt, 8czy, 8dae,
8dal, 8dbm, 8dbo, 8def, 8dev, 8dey, 8dgl,
8dgo, 8dgp, 8dgt, 8dhw, 8dnf, 8doo, 8doq,
8dse, 8es, 8gz, 8jq, 8kc, 8kk, 8nt, 8or, 8pl,
8pu, 8rv, 8ry, 8tr, 8tt, 8tw, 8up, 8vp, 8vt,
8vx, 8wo, 8xb, 8xs, 8ze, 8zf, 8zg, 8zw, 8zz,
9abf, 9adq, 9adx, 9aey, 9auf, 9agj, 9agy, 9alo,
9aju, 9akd, 9amx, 9aod, 9aor, 9apy, 9ark,
9ash, 9auw, 9axx, 9azl, 9azr, 9bcd, 9bcj,
9bcy, 9beg, 9bfg, 9bf, 9bht, 9bht, 9bht,
9bie, 9biq, 9biz, 9bje, 9bjl, 9bjl, 9bkl, 9bmv,
9bmx, 9bnk, 9brx, 9buk, 9bva, 9bw, 9byd,
9byj, 9byl, 9bzg, 9cap, 9ccm, 9cee, 9cga,
9cgn, 9cgs, 9cjo, 9cjs, 9cju, 9ckl, 9clj, 9clq,
9clx, 9cp, 9cpm, 9cro, 9csn, 9ctr, 9cvo,
9cxg, 9cxq, 9cxw, 9cxa, 9cyd, 9czv, 9dae,
9db, 9dbj, 9dbm, 9dbp, 9ded, 9dfz, 9dlj,
9dlm, 9dlw, 9dmx, 9dng, 9dnn, 9dox, 9dpl,
9dpx, 9dq, 9dqu, 9dva, 9dxy, 9dyt, 9dzv,
9dzw, 9ead, 9eak, 9eas, 9ebh, 9efc, 9efh,
9efy, 9efz, 9eht, 9ehy, 9ej, 9ejl, 9ek, 9eky,
9elb, 9em, 9ep, 9es, 9hk, 9kb, 9mn, 9nv,
9ny, 9oa, 9of, 9ql, 9ro, 9tc, 9vz, 9xbg, 9xbp,
9xi, 9yb, 9zd, 9zt, ncg, nff, nfv, nht.

Canadian: 1ar, 2ax, 2az, 2be, 2cg, 2fo,
3aa, 3ly, 3vh, 3wu, 3xl, 3zb, 5ge, 9bw.

Mexican: bx.

New Zealand: 2ac, 4aa, 4ak.

Porto Rican: 4sa.

By Deen W. Imel. 6B01-Ex 9BZZ, care of
U. S. S. Wood, Vallejo, Calif.

1bgc, 1bvl, 1er, 1ow, 1xam, 1lxw, 2aay, 2be, 3bhv, 4cb, 4cr, 4iz, 4ku, 4tj, 4pb, 4pd, 5afh, 5ef, 5ew, 5gu, 5hk, 5jf, 5nj, 5og, 5oq, 5ox, 5ph, 5qk, 5ue, 5xa, 5yd, 5za, 6aff, 7abb, 7acf, 7adf, 7adr, 7afb, 7afk, 7afo, 7ahc, 7aho, 7ahs, 7aim, 7aix, 7aiy, 7ajt, 7ajy, 7akk, 7akx, 7ao, 7ar, 7au, 7ax, 7cf, 7cw, 7dd, 7df, 7do, 7fd, 7fg, 7ff, 7fr, 7gb, 7gh, 7gj, 7gk, 7gq, 7gv, 7gw, 7ho, 7ij, 7iw, 7ku, 7kz, 7le, 7ls, 7lw, 7mf, 7mp, 7mv, 7nh, 7no, 7nx, 7ob, 7ok, 7pj, 7qc, 7qf, 7ry, 7sf, 7sy, 7un, 7uv, 7vn, 7zm, 7zu, 8aav, 8ah, 8bgn, 8ced, 8cne, 8cse, 8cva, 8dat, 8dea, 8dpn, 8gh, 8mr, 8tt, 8vq, 8vy, 8xs, 8zz, 9ado, 9aiw, 9and, 9atl, 9azr, 9bcd, 9bce, 9bcf, 9bch, 9bji, 9bkx, 9bkz, 9bnk, 9bob, 9bof, 9bqi, 9brb, 9bso, 9bus, 9bv, 9ca, 9caa, 9cek, 9cfl, 9cfy, 9ciii, 9cjs, 9ciu, 9cid, 9clt, 9del, 9dfw, 9dhw, 9dte, 9dun, 9dvi, 9camt, 9eat, 9eff, 9ejn, 9eky, 9hn, 9me, 9wo, kds, ndf, nfv, wgh.

Canadian—4aa, 4br, 4cr, 4cv, 4go, 4hh, 4as, 4ba, 4bf, 4bz, 4cp, 4fi, 4go, 4hs.

Foreign—16a.
Received on one tube through NPG arc
mush.

By 9CVL, 938 S. 4th St., Atchison, Kans.

9CVL, QSL's to all hrd from QRK, 5
watts.

1abf, 1abn, 1agx, 1akz, 1all, 1aqm, 1ars, 1aur, 1bc, 1bgq, 1bjg, 1bsd, 1cuc, 1er, 1fd, 1iu, 1my, 1pq, 1rv, 1se, 1te, 1ts, 1vj, 1wr, 1xae, 1xax, 1zab, 2acs, 2al, 2ats, 2bkn, 2bkr, 2bm, (2bqb), 2brb, 2by, 2cbk, 2ce, 2cee, 2chz, 2cgr, 2ck, 2cnk, 2cnp, 2coh, 2cqz, 2crp, 2ctq, (acty), 2cv, 2cvi, (2czr), 2kb, 2kf, 2mu, 2ov, 2rb, 2rd, 2sy, 2wu, 2wz, 2xbf, 2xd, 3ach, 3acr, 3ad, 3adp, 3aha, 3api, 3auv, 3avj, 3bio, 3bg, 3bi, 3bj, 3bec, 3bng, 3bsb, 3bta, 3buf, 3buk, (3bva), 3bz, 3cdn, 3cg, 3cgc, 3ch, (3cjin), 3co, 3cpn, 3hw, 3jo, 3ig, 3lj, 3me, 3mo, 3qt, 3qw, 3tf, (3wb), 3xx, 4af, 4ai, 4bx, 4cl, 4cr, 4dx, 4eg, 4fa, 4fb, 4gq, 4gw, 4es, 4eq, 4hs, 4if, 4ii, 4ik, 4jr, 4jw, 4kk, 4kl, (4mb), 4mi, 4my, 4oi, 4gu, 4pd, 4rr, 4sb, (4si), 4sh, 4sn, 4tn, 4tw, 4wi, 4yy, 6aam, 6aan, 6aao, 6abk, 6acl, 6acm, 6acu, 6ad, 6adh, 6adx, 6adt, 6afq, 6afs, 6agk, 6agl, 6ahm, 6ahp, 6ahu, 6aia, 6aie, 6air, 6aiu, 6aiw, 6aja, 6ajf, 6ajh, 6ajo, 6ak, 6aka, 6akn, 6aks, 6akz, 6ale, 6alk, 6alo, 6alw, 6ams, 6amw, 6anb, 6ane, 6anl, 6ano, 6anp, 6anq, 6ao, 6aol, 6aoo, 6aos, 6aou, 6ape, 6apw, 6arb, 6arf, 6aro, 6aru, 6asa, 6asj, 6asp, 6asw, 6aue, 6aup, 6aut, 6auy, 6auv, 6av, 6ab, 6aw, 6awr, 6aws, 6awt, 6ab, 6bah, 6ban, 6bbc, 6bbq, 6bbt, 6bbu, 6bbw, 6bca, 6ayg, 6bcb, 6bel, 6bcz, 6bd, 6bd, 6bdt, 6bdu, 6bel, 6beo, 6beq, 6bez, 6bfb, 6bh, 6bh, 6bh, 6bic, 6bid, 6bih, 6bip, 6bis, 6bft, 6bjj, 6bjq, 6bjx, 6bkj, 6bkx, 6blb, 6blm, 6blw, 6bm, 6bma, 6bmd, 6bnc, 6bnt, 6bnu, 6bo, 6bpf, 6bpm, 6bpz, 6bp, 6bq, 6bqr, 6brf, 6brg, 6bri, 6brm, 6bse, 6bsh, 6bsj, 6bsn, 6bsw, 6bwt, 6bts, 6btt, 6bua, 6buf, 6buh, 6bui, 6bum, 6buo, 6bur, 6bus, 6buy, 6bve, 6bv, 6bvs, 6bvz, 6bwe, 6bwp, 6by, 6cai, 6eaw, 6ebb, 6ccf, 6cbi, 6cbu, 6cbw, 6bdz, 6cc, 6cci, 6ccy, 6cde, 6cdg, 6cdm, 6cef, 6cej, 6cek, 6cep, 6ceu, 6cfe, 6cfm, 6cfq, 6cfy, 6cfz, 6cgd, 6cgg, 6cgo, 6cgr, 6cgs, 6cgw, 6chl, 6che, 6chu, 6chw, 6chx, 6chv, 6chz, 6cia, 6cid, 6cih, 6cix, 6jb, 6jv, 6cka, 6cke, 6cki, 6clr, 6cmr, 6emt, 6cmu, 6cng, 6cuh, 6cn, 6cod, 6cqe, 6crx, 6cua, 6bdb, 6eto, 6ea, 6eb, 6ec, 6egl, 6ej, 6en, 6eo, 6eq, 6ev, 6fh, 6fp, 6fm, 6fy, 6gg, 6gj, 6gk, 6gl, 6gr, 6gt, 6im, 6ip, 6iw, 6ja, 6js, 6jt, 6ka, 6kj, 6ll, 6ln, 6lu, 6lw, 6mh, 6ms, 6nb, 6ne, 6nx, 6od, 6ol, 6pe, 6pl, 6pu, 6ql, 6qj, 6rd, 6rn, 6su, 6tu, 6tv, 6uo, 6ul, 6uw, 6ux, 6vd, 6vf, 6vk, 6wt, 6wv, 6xe, 6xl, 6yb, 6xbn, 6za, 6zah, 6zar, 6zb, 6zh, 6zg, 6zo, 6zr, 6zl, 6zu, 6zar, 6zb, 6zh, 6zg, 6zo, 6zr, 6zl, 6zu, 6zbt, 6zbi, 6zbo, 6zca, 6zz, 7aa, 7aas, 7acf, 7ach, 7acl, 7adi, 7adr, 7ads, 7aea, 7af, 7afn, 7afo, 7afs, 7afu, 7afy, 7agi, 7agr, 7agv, 7ah, 7ahs, 7ahr, 7adk, 7aiy, 7age, 7aj, 7ajd, 7ajt, 7ak, 7akh, 7akk, 7ald, 7alk, 7ame, 7ant, 7asv, 7ao, 7at, 7be, 7bj, 7co, 7cz, 7dd, 7ss, 7em, 7ey, 7fd, 7fq, 7fr, 7ga, 7gi, 7gk, 7go, 7gr, 7gs, 7gw, 7ha, 7hg, 7hw, 7ig, 7ig, 7io, 7it, 7iw, 7id, 7kg, 7kk, 7ks, 7kv, 7kz, 7ln, 7ls, 7lu, 7lw, 7ma, 7mr, 7mr, 7ms, 7ny, 7ob, 7no, 7om, 7ot, 7pl, 7qb, 7qc, 7qd, 7qi, 7aj, 7no, 7rd, 7ry, 7se, 7sf, 7sh, 7to, 7tv, 7tx, 7uc, 7ue, 7uf, 7ve, 7wm, 7wp, 7xaf, 7xg, 7xi, 7yc, 7zd, 7zo, 7zu, 7zv, 7zl.

Canadians—1ad, 1ar, 1bj, 1bq, 1bv, 1ef, 2be, 2bg, 2bn, 2cg, 2co, 2dn, 2fc, 2hv, 2ic, 3aa, 3abc, 3abn, 3ad, 3ada, 3adn, 3ads, 3adv, 3ae, 3aec, 3aft, 3aiy, (3ak), 3aq, 3at, 3av, 3ba, 3bg, 3bi, 3bj, 3bq, 3ck, 3cy, 3db, 3dn, 3dz, 3fc, 3gg, 3he, 3hi, 3hp, 3hy, 3ir, 3iv, 3jt, 3kg, 3ko, 3kp, (3kq), 3kw, 3mi, 3mn, 3ms, 3nm, 3ni, 3oh, 3oi, 3om, 3pg, 3pz, 3qn, 3qs, 3sp, 3tb, 3ti, 3un, 3vh, 3wg, 3ws, 3ww, 3xl, 3xn, 3xx, 3yh, 3yv, 3zl, 3zs, 3zt, 4aa, 4ag, 4aj, 4ao, 4aw, 4cb, 4co, 4cr, 4er, 4fz, 4hh, 4nf, 4ta, 4dy, 5cn, 5go, 9al, 9ar, 9bg, 9bj, 9bx, 9ce.
Cuban—2by, 2ww.
"JU PU."

They say~

- 1 "Greater clarity and volume. Amplification is always at a maximum in each stage for any wave-length. Three stages audio frequency amplification."
Zenith amplifies with Thordarsons!
- 2 "The Kennedy tone quality is superb; full-rounded, musically pure reproduction of any program within a good long range. No hollow tones or distortion. For the Kennedy is a musical instrument. A musician will enjoy its purity of tone."
Kennedy amplifies with Thordarsons!
- 3 "To hear the real voice of the nation full and clear—you want volume... Volume that floods your room... Distant stations can be tuned in with remarkable clearness and volume."
Murdock amplifies with Thordarsons!
- 4 "It secures the finest tone and high selectivity with increased volume and distance. It brings to the home—a reproduction of music really comparable to the original. In volume the Deresnadyne will give anything from a mute tone to a volume that fills a large hall."
Deresnadyne amplifies with Thordarsons!

NOTE:— that Thordarson makes a 2:1 audio—also an Inter-stage Power Amplifying Transformer. Prices below.

Superiority Proved!

ZENITH
KENNEDY
Radiodyne
Pathé
ULTRADYNE
MURDOCK
MICHIGAN
Howard
OSARKA
MUSIO
PANSTIEHL
PHOENIX
ANDREWS
MALONE LEMON
AUDIOLA
GATES
GLOBE
HARMONY
ODELL FERRY
PEERLESS
DUCKS DELUXE
SAAL
AND MANY OTHERS USE
THORDARSONS

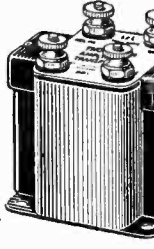

Note the emphasis placed upon tone quality in the advertising of the finest sets—the sets that have Thordarson amplification. People want radios that are musical instruments. Leading makers are responding with sets embodying the best audio amplification. That is why more Thordarsons than all competitive transformers combined are now used in high-grade radios.

Is your present set disappointing? Buy a Thordarson-equipped set—or replace your audio frequency transformers with a pair of Thordarsons—or follow the lead of the leaders and build with Thordarsons. You will be delighted with the even volume they deliver over the entire musical range. All stores can now supply Thordarsons. If your dealer is sold out, you may order from us by mentioning his name. Interesting bulletins sent free. Write.

THORDARSON ELECTRIC MANUFACTURING CO.
Transformer specialists since 1895
WORLD'S OLDEST AND LARGEST EXCLUSIVE TRANSFORMER MAKERS
Chicago, U.S.A.

Unconditionally Guaranteed

THORDARSON

Super
AMPLIFYING TRANSFORMERS

Standard on the majority of quality sets

TYPES AND PRICES: Thordarson "Super" Audio Frequency Transformers are now to be had in three ratios: 2-1, \$5. 3½-1, \$4. 6-1, \$4.50. Thordarson Power Amplifying Transformers are \$13 the pair. Thordarson Interstage Power Amplifying Transformer. \$8.00. Write for latest hook-up bulletins—free!

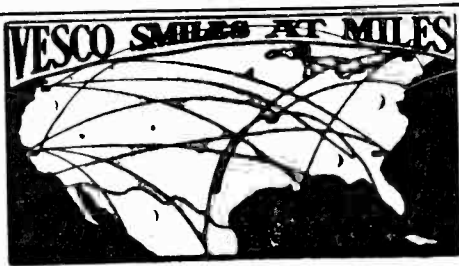

ON ONE TUBE

BIG FREE BOOKLET tells the story. California users of CROSS COUNTRY CIRCUIT hear Atlantic Coast, Canada, Cuba, Mexico and Hawaii. Atlantic Coast users hear England to California. Our new plan makes this set easiest and cheapest to build. One hour puts in operation. One tuning control. No soldering. Any novice can do it. Big Booklet Free or complete instructions for 25c stamps or coin. VESCO RADIO CO., Box R-117, Oakland, Calif.



Build a Super-Heterodyne with the Improved "Airkore" Transformer

Points of Construction

1. Each transformer is shielded with a NON-MAGNETIC SHIELD, which prevents interaction between the radio frequency stages and does away with using bulky shields, thus simplifying the construction of a Super-Heterodyne. A binding post is furnished on each shield for connection to Neg. A. Battery.
2. Accurately matched in sets of four.
3. Moulded of genuine Bakelite.
4. Kit includes 3 matched intermediate transformers, 1 matched input transformer. Complete Blue Prints giving every detail for the making of an eight tube set.

PRICE \$20.00
Jobbers and Dealers write.
THE RADIOPHONE EQUIPMENT CO.
Write for Booklet. 1409 W. York St., Philadelphia, Pa.

The FEBRUARY ISSUE of "RADIO" will be a knockout

Tell them that you saw it in RADIO

The Last Word in Radio McCall Compensated Circuit

Air
Roamer



All requirements of a modern receiving set are met in the "Air Roamer"—a McCall Compensated Circuit set of advanced design, electrically and mechanically perfect. Being non-regenerative it does not re-radiate. Superior in Selectivity, quality of Reproduction, Volume, and Logs Accurately. These four much-desired features now combined in this ONE set.

Manufactured by the long-established

Kilbourne & Clark Mfg. Co.

SEATTLE

BRANCHES: 1103 W. Tenth Street, Los Angeles
171 Second Street, San Francisco
53 4th Street, Portland, Ore.

Australian Distributors: Pacific Electric Co., Sydney

A sensation among radio fans!

Like countless others, you too will welcome the results given by Airtron Tubes. Due to their improved, scientific construction, every syllable and note comes in on an Airtron flawlessly clear, round, full and natural in tone. And they're guaranteed for stamina—good, long, active service. Used and endorsed by Radio Authorities.

Type 200—6 Volt, 1 Amp. Det.
Type 201A—5 Volt, 25 Amp. Det. and Ampl.
Type 12—1½ Volt, 25 Amp. Det. and Ampl.
Type 199—¾ Volt, .06 Amp. Det. and Ampl.

List Price, \$4.00

Sold by all dealers, or shipped C.O.D. direct by parcel post.
Mention type when ordering.

H. & H. RADIO CO.

Dept. 106, 514 Clinton Avenue, Newark, N. J.



DEALERS—Write
for Discounts

AIRTRON

RADIO TUBES

RADIO IN NEW ZEALAND

By IVAN M. LEVY

Down here in the Southern Seas we are just emerging from what may be termed the "wooden age" of radio, but the advance is rapid, and ere long we will be as up-to-date, if not in advance, of any other country in the world. New Zealand, it must be understood, is a country entirely apart from the great Commonwealth of Australia, both physically and in government. The nearest port of New Zealand is about four days steaming from Sydney, the nearest port of Australia, which is distant some 1,200 miles from Wellington. New Zealand has a population of about 1,300,000, and Australia's population is somewhere about 6,000,000.

In New Zealand during the past eighteen months we have had broadcasting carried on by about eight stations. They have been maintained in nearly every instance by the radio "trade" of each center, without any direct payment by listeners-in, who now number about 3,500. These stations have been of low power, excepting in the case of two in the city of Dunedin, which closed down owing to the heavy cost of maintenance.

There are now two "trade" broadcasting stations in the city of Auckland—one of about 110 watts output, and the other of about 15 watts. They have arranged things so that there is broadcasting in Auckland every night of the week, only one station operating on each night. The programs vary from gramophone items to proper concerts by amateur and occasionally professional performers, none of whom, however, receive payment for appearing at the broadcasting stations.

This system obtains in the other New Zealand cities also. In Wellington, the "trade" maintained two separate stations of 15 watts input, operating every night excepting on Saturdays, only one station transmitting on any night. The cost of maintenance of two stations prompted the "trade" to get together, and as a result one station has been shut down, and the upkeep of the other is now contributed to by the whole local "trade."

In Christchurch, a member of the "trade" transmits with about 15 watts input, on two or three nights a week. In Dunedin the proprietor of the 500-watt station, a member of the "trade," has become so disgusted with the lack of support from any other member of the local "trade" that he has closed down his station. In the township of Gisborne a member of the "trade" is transmitting on two or three nights a week with about 50 watts input, and another dealer in the township of Nelson also operates two or three nights a week with a 15-watt plant.

There are about 60 amateur transmitters spread over the two islands of

New Zealand. They employ power varying from 5 watts up to 50 watts, and one or two use as much as 100 watts occasionally. Spark transmission by amateurs is prohibited by the Government regulations, which, in this country and in Australia, are administered by the State Post and Telegraph Department, with a Minister of the Crown, the Postmaster General, as the head.

Wellington, the capital, is geographically about the center of New Zealand, and is the chief seaport. The distance of the various cities from Wellington are as follows: Auckland, 304 miles; Christchurch, 175 miles; Dunedin, 390 miles. It may be that the insular character of this country has a considerable influence on DX reception, and many Wellington listeners-in receive the concerts from the 500-watt broadcasting station in Dunedin, employing the popular three-coil regenerative receiver, with only one valve. Indeed, many New Zealanders using only one valve regularly receive the concerts from KGO, California, and, employing three-valve regenerative three-coil receivers KGO is brought in on a loud speaker.

With regard to wavelengths, the Government regulations, following the United States (very wisely) provide for broadcasting on a waveband below 500 meters. The amateur transmitters are restricted to wavelengths of from 140 to 180 metres. This, of course, enables the average imported American variometer receiver to be of good practical value in New Zealand.

While this situation does not appear very promising, it merely marks the transition to greater things. An empowering bill will be submitted to the House of Representatives which will enable the Post and Telegraph Department to increase the present listeners-in license fee from 5/- (a few cents more than a dollar per annum to about £1 9/6 (about seven dollars), out of which a national broadcasting company will receive from the Department about £1 5/- (about six dollars). The broadcasting company, which is about to be floated, will be required to erect a thoroughly up-to-date station of 500 watts output in Auckland, Wellington, Christchurch and Dunedin. The initial capital of the company is to be £30,000. Investors are to be offered stock, or debentures, at a fixed interest of about 7%. The radio dealers are to be asked to subscribe a substantial proportion of the capital, but the Government proposes to limit the possible return on the capital as in Great Britain.

Listeners-in throughout New Zealand are eagerly awaiting the inauguration of the scheme, and are quite prepared to pay the added cost of their license fees. Under the new scheme professional talent will be paid for performing at the broadcasting stations.

Anti-capacity JACKS

Anti-capacity SWITCHES

Lower-Loss Vernier VARIABLE CONDENSERS

Lower-Loss PHONE PLUGS

Lower-Loss RHEOSTATS

Lower-Loss SOCKETS

Lower-Loss VARIO-COUPPLERS

Lower-Loss GRID LEAKS

Lower-Loss INDUCTANCE SWITCHES

Lower-Loss POTENTIOMETERS

No Soldering Scientifically Built Less Drilling

DX—but not only DX— Volume and Tone!

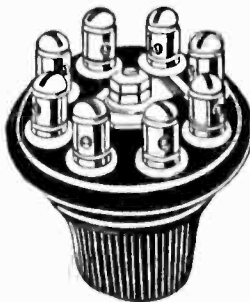

JOS. W. JONES
Low Loss
INDUCTANCE
SWITCH

All Jos. W. Jones radio parts are low loss. So a set built with these parts bring in longer DX with greater clarity, selectivity and more natural tone.

Jos. W. Jones parts make set-building easier, too, for they require *less drilling* and *no soldering*.

Jos. W. Jones Jacks and Switches are *anti-capacity*. Made for radio use only. No long parallel leads; which means no capacity effects.

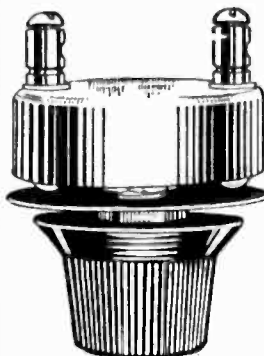

JOS. W. JONES
Low Loss
GRID LEAK

For Best Results Build
with JOS. W. JONES

Jacks	Rheostats
Switches	Vario-couplers
Sockets	Potentiometers
Grid Leaks	Inductance
Variable	Switches
Condensers	Phone Plugs

Always ask for the switches with the little red button

JOS. W. JONES TRADE MARK "IMPROVED"

radio parts

JOS. W. JONES RADIO MFG. CO., INC.
40-42-44-46 W. 25th St., New York
(Formerly Radio Improvement Co.)

Headed by Jos. W. Jones—for 28 years a successful engineer and builder of precision instruments

Branch Offices
Philadelphia: 1011 Chestnut Street Boston: 99 Bedford Street

GET STATIONS YOU NEVER HEARD BEFORE

Tune your tubes and get volume without distortion.

Send 2c stamp for booklet, "Improved Reception Through Scientific Tube Tuning." Dept. R 125.
D X Instrument Co., Harrisburg, Pa.

RADIO Buyers' GUIDE

For Consumers 100 Pages
Get it now—before you buy any set or parts to build one. **FREE** Just send your name.

Business in all kinds of complete Sets, Parts and Accessories (Will you be so kind as to add the name of one or more friends you believe will soon want radio goods? Thank you!)

Liberty M. O. House, Dept. A675 106 Liberty St., N.Y.

Use RESISTANCE!

DURHAM

Grid Leaks **75¢**

Variable:—
No. 101—1.10 to 5 megs.—soft tubes
No. 221A—2 to 10 megs.—hard tubes
No. 100—1000 to 100,000 ohms by-pass.

Metalized Fixed:—
Over 1/2 meg. 50¢; under, 75¢.

at dealers or postpaid
DURHAM & CO., INC. 1936 Market Street, Philadelphia

Each Instrument of the Orchestra in PERFECT TUNE

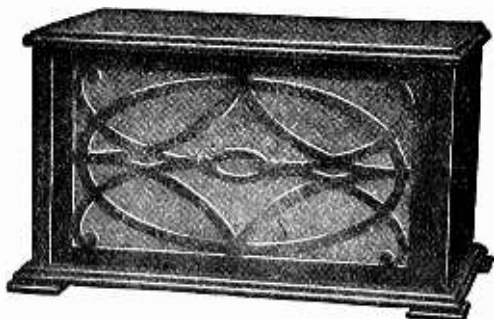

CABINET MODEL—\$30.00
Size 17x10x10¼". Beautifully finished mahogany. Full-floating wooden horn. Cast metal throat.

It makes all the difference in the world with the enjoyment you get out of radio whether the high notes of voice and orchestra are in tune or just a little "off."

A big point of the Bristol Audiophone is that each instrument, and each vocal note, comes in in proper pitch. You will love your Audiophone for its pure harmony of reception.

There are four Bristol Audiophones, priced from \$12.50 to \$25.00, and a cabinet model at \$30.00. If not at your dealer's, write for Bulletins Nos. 3011, 3017 and 3022 -R.

THE BRISTOL COMPANY
Waterbury, Conn.
BRISTOL AUDIOPHONE
LOUD SPEAKER

BRISTOL TRADE MARK AUDIOPHONE MADE IN U.S.A. Loud Speaker

CORRESPONDENCE COURSE IN RADIO

The addition of radio instruction courses by correspondence to the long list of home study subjects offered by the Pennsylvania State College has turned out to be one of the most popular movements ever undertaken by the college Department of Engineering Extension.

Inquiries by the hundred followed the initial announcement about a year ago that the college would offer courses for novices as well as for advanced students of radio. Enrollment of students for the favorite subject followed in large numbers when it was found that because the college is a state institution the courses were offered at mere cost of preparation and correction of lessons. The radio courses had the largest enrollment of all the 127 miscellaneous home-study courses offered last year by the engineering extension department.

Professor N. C. Miller, who is head of the department, stated that he received so many requests for radio correspondence courses that last fall it was decided to offer two, in radio reception and transmission, one elementary and the other advanced.

"The Penn State courses in radio were prepared with the idea that amateurs are desirous of something more than blindly following blue-prints and pictured hook-ups. The fundamentals and advanced theory are made very plain.

"The short elementary course can be studied profitably by anyone who has a grammar school education.

"For the advanced course a knowledge of algebra sufficient to use formulas and an ability to understand data presented in the form of curves and tables is all that is needed. Enrollments in either course may be made at any time; there are ten lessons in each course." The courses are not primarily of the "how to build" variety, Professor Miller further explains. It is realized that the construction field is covered splendidly by such mediums as "Radio." This decision seems to have been a wise one as the student concentrates on fundamentals unhampered by mechanical details. In addition, it is obvious that hardly two persons would wish the same set out of the hundreds of hook-ups available through various other sources.

For the same reason casual queries on individual sets are eliminated to enable the instruction to be concentrated on the principles presented.

The first course costs \$10 and teaches: What radio is, the principles of radio electricity, how telephone, crystal and vacuum tube receiving sets work, how to get proper amplification, to select the right type of receiving set, to operate and care for radio receiving sets, to construct radio receiving sets, to test them, to locate common troubles and how to remedy them.

EASIER - BETTER TUNING WITH B-T PARTS

That's just what you get. Stronger signals, greater distance, surpassing selectivity with little or no effort. It's being done by hundreds of others. Why not you?

The sixth edition of our 40-page book, "Better Tuning," tells you why and shows you how. Hook-ups, construction, tuning and general information on crystal to five tube R. F. circuits. Sent postpaid for 10c.

See the B-T parts at your dealers, or write for detailed information today.

BREMER-TULLY MFG. CO.

532 SO. CANAL ST., CHICAGO, ILLINOIS

Type	Plates	M.M.F.	Price
7-L	7	125	\$4.25
11-L	13	250	4.50
23-L	23	500	5.00
35-L	35	750	6.50

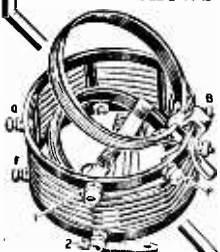
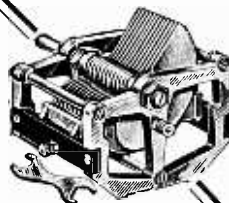

B-T LOW LOSS TUNER
Made for Broadcast or Short Wave
Type B, 200 to 565 \$5.00
Type SW, 50 to 150 5.00

A Dozen Thrilling Yarns

Read the Story of the Life of a Sea-going Radio Operator—
"THE RADIOBUSTER"

SENT POSTPAID ANYWHERE

PACIFIC RADIO PUB. CO.
Pacific Bldg., San Francisco, Cal.

\$1.00
Per Copy

\$1.00
Per Copy

One supplementary section gives accurate working drawings (as actually used in radio shops) together with complete lists of materials required for constructing eight typical radio receiving sets.

It also gives up-to-date information on such topics as: Control of static, atmospheric and directional effects, radio maps, thermo-electric A and B batteries, radio photography, methods of locating open and short circuits, testing for defects in transformers, vacuum tubes, antennas, ground wires, etc.

This is a popular course, especially suited to amateurs, radio salesmen and others who wish a thorough knowledge of the fundamentals of the science, without the mathematical treatment necessary to Part II.

The second course costs \$15 and is intended for technical men and amateurs desiring the mathematical treatment of the subject together with the electrical theory involved.

It covers: Elementary electricity, radio circuits, electro-magnetic waves, damped wave transmission, the electron tube, apparatus for reception, the tube as a generator, radio telephony.

The text-book of Part II is a 600-page volume which will be very valuable as a reference book after the student finishes the course. It is the work of a number of eminent physicists and electrical engineers, compiled by the U. S. Bureau of Standards.

The assignment pamphlets for Part II, in addition to the questions, etc., contain other matter not included in the text-book furnished with the course. These are of assistance in clearing up the more difficult parts of the text.

Those taking this course will need sufficient algebra to handle formulas and solve ordinary equations. The student must also be able to read tables and curves.

HOOVER SUGGESTS SHORT BILL FOR CONTROL OF RADIO

Secretary of Commerce Herbert Hoover has submitted to Representative Wallace H. White a suggestion for a very short bill to be passed by Congress. This bill is intended merely to clarify the powers of the Department in regulating interference, postponing further legislation until more definite data are available.

It declares and re-affirms the fact that the ether "is the inalienable possession of the people" and "that the authority to regulate its use in interstate and foreign commerce is conferred upon Congress by the Federal Constitution." It further provides that "the wave length of every radio transmitting station for which a license is now required by law, its power, emitted wave, the

Continued on page 110



B.M.S. fan tail JACK

LUGS both cupped and fantailed! These two exclusive features reduce the work of soldering connections to the absolute minimum. No more fussing and fuming with busbar leads to the jack! Your dealer has

B.M.S. JACKS In All Styles

If you want compactness use TRI-JACKS. A zero capacity dust-proof, solderless Jack that combines three jacks in one. Fits any standard plug.

Ask your dealer!

TRI-JACK

BROOKLYN METAL STAMPING Corp.
718 Atlantic Ave.,
Brooklyn N.Y.

90¢



One Pull on the Jones MULTI-PLUG instantly disconnects antenna, ground, A and B batteries from your set. One push reconnects. And it can't be plugged in wrong! Eight foot cable permits placing batteries out of way—in basement, closet or elsewhere. Makes your set portable. All leads plainly coded.

Jones MULTI-PLUG

THE STANDARD SET CONNECTOR

Nothing else like it. Enables anyone to connect your set with safety. Prevents burning out tubes or shorting batteries. 100 per cent foolproof. Standard on Zenith, Workrite and many other leading sets. Ask your dealer to put one on the set you buy, if it isn't already equipped. Carried by all jobbers. Any dealer can supply you. May be ordered direct by stating dealer's name. Folder mailed free.

Blinding Post Type complete with seven coded leads for attaching to binding posts of any set and 8 foot coded cable \$5.00

Patent Applied For

Lombard J. Smith,
24 North San Pedro St.,
Los Angeles, California

Mr. A. S. Lindstrom,
111 New Montgomery St.,
San Francisco, California

Mr. H. A. Killam,
146 1/2 North Tenth St.
Portland, Oregon

Mr. G. H. Maire,
95 Connecticut St.,
Seattle, Washington

HOWARD B. JONES, 614 S. Cana Street, Chicago

Used Radio Apparatus For Sale at Low Prices
Read the "RADIOADS"
Page 111

5c

brings you a copy of "Radiocast Weekly" for Pacific Coast **RADIO-CAST WEEKLY** 433 Pacific Bldg. San Francisco

Photos
Programs
Schedules
Humor
Reviews
News, Etc.

Takes the MYSTERY out of RADIO!

Just one book answers every question about this modern miracle



100,000 SOLD
514 PAGES

Compiled by **HARRY F. DART, E.E.**

Formerly with the Western Electric Co., and U. S. Army Instructor of Radio.

Technically Edited by **F. H. Doane**

BE A RADIO expert—it's easy for the 100,000 who own this compact, complete Radio Handbook. Written in good, plain, understandable language. Crammed full of facts, every one useful and important. Explains how receivers and transmitters work, how to build and operate them. Whatever you or your friends want to know, it's here. Will save you many times its small cost.

TELLS ALL ABOUT: Electrical terms and circuits, antennas, batteries, generators and motors, electron (vacuum) tubes, every receiving hook-up, radio and audio frequency amplification, broadcast and commercial transmitters and receivers, super-regeneration, codes, license rules. Many other features.

Nothing else like it. Make this extraordinary book your radio library—just this one little giant is all you need! Everything in one index, under one cover, in one book, for one dollar. The biggest dollar's worth in radio to-day. Combines the knowledge of many expensive works. Buy this and save the difference. Stop experimenting in the dark. Before you spend another cent on parts or even touch a dial, sign and mail the coupon below and get this unique guide to successful radio. More than 100,000 sold.

Send \$1 to-day and get this 514-page I. C. S. Radio Handbook—the biggest value in radio to-day. Money back if not satisfied.

TEAR OUT HERE
INTERNATIONAL CORRESPONDENCE SCHOOLS
Box 8264-B, Scranton, Penna.

I enclose One Dollar. Please send me—post-paid—the 514-page I. C. S. Radio Handbook. It is understood that if I am not entirely satisfied I may return this book within five days and you will refund my money.

Name.....

Address.....

Check here and enclose \$1.50 if you wish the deluxe edition, bound in Leatheroid.

LATEST RADIO MARVEL THE PARAMOUNT LOOP

A Master Product that by virtue of its unique, scientific construction, gathers and sends to the receiver, without customary absorption, every electron of current.
SPIDER-WEB wound with silk over phosphor-bronze wire, mounted on genuine Bakelite frame.

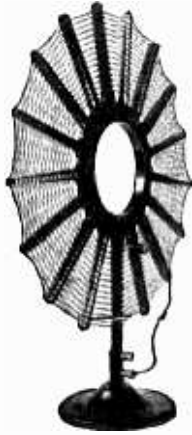

Develops greater
Volume
Clarity
Directional Effect
Receivability
"A Loop
Eventually—
Why Not the
Best?"

Dealers and
Jobbers—
Write Today

LIST
PRICE
\$12.00

Patent
Pending

Paramount Radio Corporation
23 Central Avenue, NEWARK, N. J.

DONGAN

Perfect Balance

This is the
Audio Frequency
Transformer
Selected

by Popular Radio

to use in building the "Low Loss Short Wave" Receiver described in the November issue.
Dongan Type C Audio Frequency Transformer possesses that happy Transformer combination—the quality of maximum amplification with minimum distortion. Built for all tubes and hook-ups—

Ratios 3½ to 1 and 6 to 1.

VOLTMETER

Positively accurate and reliable—saves its cost in short while. Ask about Dongan Double Duty High Resistance Voltmeter.

A REALLY BEAUTIFUL
INSTRUMENT

Details and Discounts on Request.
DONGAN ELECTRIC MFG. CO.
2981 Franklin St., Detroit, Michigan
Distributors for Western Coast:
SIERRA ELECTRIC COMPANY,
515 Market St., San Francisco
443 S. San Pedro St., Los Angeles
222 Hinkley Bldg., Seattle
ROBINSON SALES CO.,
53 Fourth St., Portland, Oregon
Transformers of Merit for 15 Years

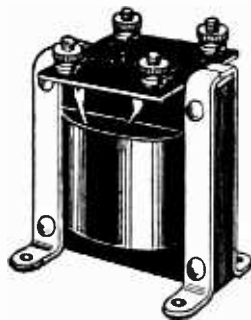

If you missed the big December issue of "RADIO," containing the article by Mathison, "On the Trail of the Tube Sharks," we will mail you a copy for 25c.

DeForest
License



HONEYCOMB COILS

The Universal all-wave inductance. Back and front panel mountings. Send 25c for Super Het., R. F. and Honeycomb Coil Circuits and Complete Catalog.

Chas. A. Branston, Inc.
819 MAIN ST. BUFFALO, N. Y.
DEPT. 12

Radio Conference Recommendations for Frequency or Wavelength Allocations

Kilocycles	Meters	Service
95-120.....	3,156-2,499..	Government CW and ICW exclusive.
120-157.....	2,499-1,910..	Marine CW and ICW, exclusive.
157-165.....	1,910-1817..	{ Point-to-point CW and ICW, } exclusive. Marine CW and ICW, }
165-190.....	1,817-1,578..	{ Point-to-point CW, ICW, spark, } exclusive. Marine CW and ICW, }
160.....	1,874.....	Government, nonexclusive.
175.....	1,713.....	Government, nonexclusive.
185.....	1,621.....	Government, ice patrol broadcasting and navigational aid messages, nonexclusive.
190-230.....	1,578-1,304..	Government CW and ICW, exclusive.
230-235.....	1304-1,276..	University, college, and experimental CW and ICW, exclusive.
235-250.....	1,276-1,199..	Marine, phone, nonexclusive.
250.....	1,199.....	Government, CW, ICW, nonexclusive.
250-275.....	1,199-1,090..	Marine, phone, nonexclusive.
275.....	1,090.....	Government, CW, ICW, nonexclusive.
275-285.....	1,090-1,052..	Marine, phone, nonexclusive.
285-500.....	1,052-600.....	Marine and coastal, including radio compass and radio beacons.
300.....	1,000.....	Radio beacons.
315.....	952.....	Government CW, ICW, spark.
343.....	874.....	Ship-to-ship and ship-to-shore CW, ICW.
375.....	800.....	Radio compass.
410.....	731.....	Ship-to-ship and ship-to-shore CW, ICW, spark, exclusive.
425.....	705.....	Ship-to-ship and ship-to-shore CW, ICW, spark, exclusive.
445.....	674.....	Government aircraft and submarines, CW and ICW.
454.....	660.....	Ship-to-ship and ship-to-shore CW, ICW, spark exclusive.
500.....	600.....	For calling and distress signals and messages relating thereto, exclusive.
500-550.....	600-545.....	Aircraft and fixed safety-of-life stations, CW ICW, phone, exclusive.
550-1,500.....	545-200.....	Broadcasting services, phone, exclusive.
550-1,070.....	545-280.....	Class 1.
1,090-1,400.....	275-214.....	Class 2.
1,420-1,460.....	211-205.....	Class 3.
1,500-2,000.....	200-150.....	Amateur, exclusive.
1,500-1,670.....	200-180.....	Amateur, CW, ICW.
1,670-1,760.....	180-170.....	Amateur, ICW, phone.
1,760-2,000.....	170-150.....	Amateur, CW, ICW.
2,000-2,250.....	150-133.....	Point-to-point, nonexclusive.
2,250-2,500.....	133-120.....	Aircraft, exclusive.
2,500-2,750.....	120-109.....	Mobile.
2,750-2,850.....	109-105.....	Relay broadcasting, exclusive.
2,850-3,500.....	105-85.7.....	Public service.
3,500-4,000.....	85.7-75.0.....	Amateur and Army mobile.
4,000-4,500.....	75.0-66.6.....	Public service and mobile.
4,500-5,000.....	66.6-60.0.....	Relay broadcasting, exclusive.
5,000-5,500.....	60.0-54.5.....	Public service.
5,500-5,700.....	54.5-52.6.....	Relay broadcasting, exclusive.
5,700-7,000.....	52.6-42.8.....	Public service.
7,000-8,000.....	42.8-37.5.....	Amateur and Army mobile.
8,000-9,000.....	37.5-33.3.....	Public service and mobile.
9,000-10,000.....	33.3-30.0.....	Relay broadcasting, exclusive.
10,000-11,000.....	30.0-27.3.....	Public service.
11,000-11,400.....	27.3-26.3.....	Relay broadcasting, exclusive.
11,400-14,000.....	26.3-21.4.....	Public service.
14,000-16,000.....	21.4-18.7.....	Amateur.
16,000-18,000.....	18.7-16.7.....	Public service and mobile.
18,000-56,000.....	16.7-5.35.....	Beam transmission.
56,000-64,000.....	5.35-4.69.....	Amateur.
64,000-infinity.....	4.69-0.....	Beam transmission.

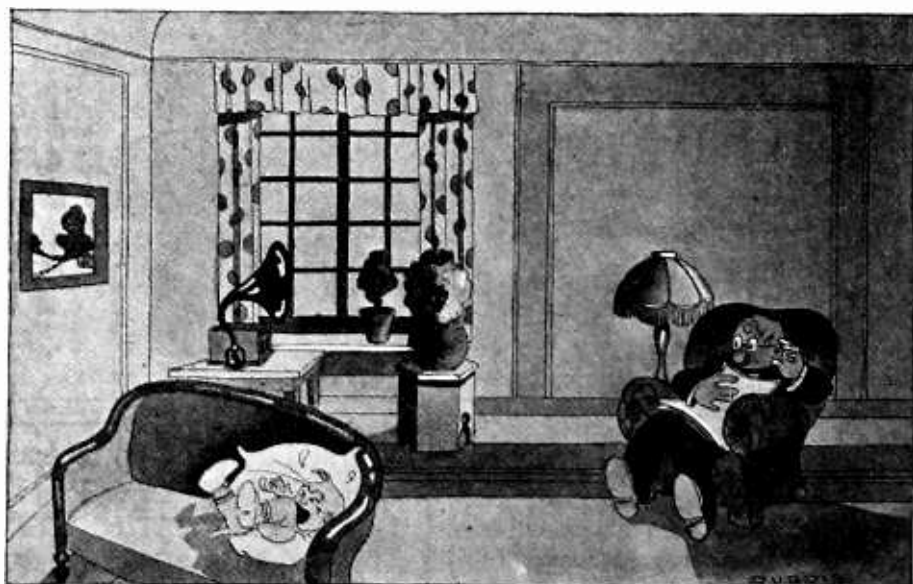

McDuff (slightly hard of hearing): "The radio seems unusually loud this evening."

Bring in the Distant Stations

You can do this only when your conditions are the best. A Weston Filament Voltmeter will tell you instantly if your tubes are receiving proper voltage. Also by operating tubes at correct filament voltage, the life of tubes is increased at least twofold. This Model 301 Weston Voltmeter costs little more than a tube. With a Weston Voltmeter you can always duplicate previous results. For quick tuning and good reception, it is an absolute necessity. Case diameter 3 1/4 in. Every instrument guaranteed. Get one for your set today. The Weston Electrical Instrument Company has pioneered the development and manufacture of electrical indicating instruments for 36 years in every branch of the electrical industry.

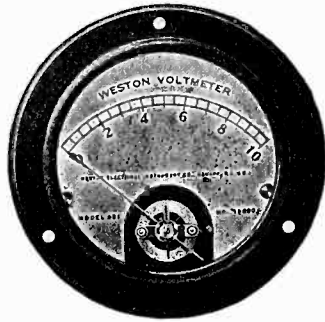

Weston Filament Voltmeter

Booklet J is a splendid 24-page booklet discussing the proper operation of a radio set. Instrument connections for the various hookups are shown. Get this book. It will be sent free on request.

Electrical
Indicating
Instrument
Authorities
Since 1888

WESTON

STANDARD - The World Over

The Quiet NILES

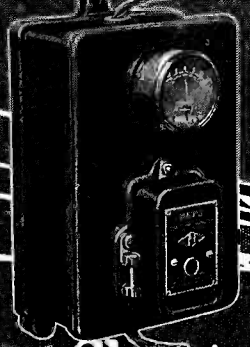

Battery Charger

IT'S EASIER TO DO IT AT HOME

Charge your batteries at home with a Quiet Niles. It's easier, quicker and cheaper. No bulbs. No liquids. No fumes. Light to handle. Delivers 72% of the current. Model A for 6-volt batteries \$19.00; Model AB for 6-volt and 24-volt batteries \$21.00. Add \$1.00 west of Rockies. Write for Literature

NILES MANUFACTURING COMPANY
Dept. 71, Ypsilanti, Mich.

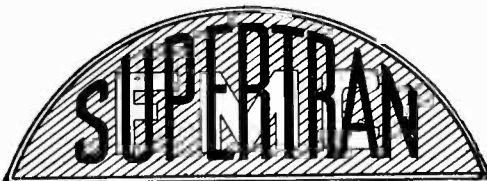

Registered U. S. Patent Office

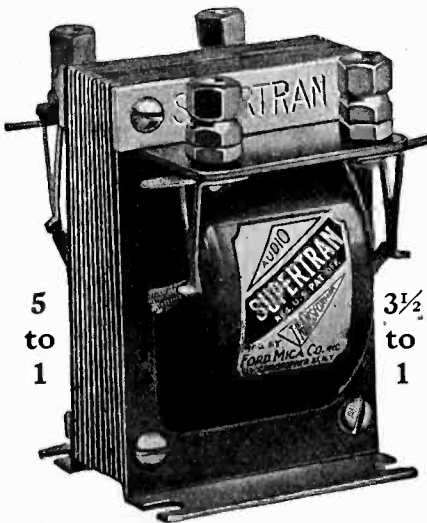

5
to
1

3 1/2
to
1

It's up to the audio transformer to amplify without distorting—to increase the volume without affecting exactness in reproduction. That's just what Supertran Audio Transformers do. They are unequalled for volume, clarity, purity and quality of tone.

An exclusive feature of the Supertran is its shield, insuring absolute protection against damage to the coil while mounting. With any amplifying tube Supertran gives excellent results.

At good dealers everywhere.
Write for interesting literature.

Price \$6.00

Distributed by

The Beckley-Ralston Co., Chicago
Coast Radio Supply Co., San Francisco
Radio Ltd., Montreal, Canada
Phillip Chandler & Co., Boston
L. W. Cleveland & Co., Portland, Me.
Gray Sales Co., Philadelphia
Waite Auto Supply Co.
Providence, R. I.

Manufactured by

FORD MICA CO., Inc.

33 East 8th St.

New York



Just what
you need

Valley Battery Charger

Here is just what you need to increase the pleasure and entertainment of your radio. With the Valley Battery Charger as part of your equipment, you need never miss a program because of a dead battery.

The Valley Battery Charger will completely recharge 2-volt peanut tube cells, 6-volt A batteries and from 1 to 4 B 24-volt batteries. It is the only charger necessary for all radio batteries.

Quiet in operation
Full 6-ampere charging rate
No liquids. No bulbs.

Plugs into the ordinary light socket like a fan or other household necessity. Just as easy to operate. Takes only about a dime's worth of current to bring your battery up to full charge.

It has grained and engraved Bakelite panel which harmonizes with any radio set. Clear glass top shows the simple, patented working parts at all times.

At radio dealers everywhere.

VALLEY ELECTRIC CO.

101 Rialto Bldg., San Francisco, Cal.



Puts the Joy in Radio

After all, what is sweeter to your ears than the music from some DX Station coming in on the loud speaker, clear and undistorted? To insure amplification without distortion, use the "HEGEHOG." This marvelous little audio transformer, half the size of any other made, is different in design—the most efficient construction known—for transformers. It has an exclusive self-shielding feature that shuts out foreign noises. Unsurpassed for volume and tone quality. Saves space, mounts anywhere and easy to connect. Ideal for portables.

Ratios 1 to 3, 1 to 4 and 1 to 5...\$3.50

Ratio 1 to 10..... 4.50

Write for Free Bulletin No. 94, showing complete line of Premier Quality Radio parts. Ask your dealer for Premier free hook-ups. If he does not have them send his name and receive a set free.

Premier Electric Company

PREMIER

Quality Radio Parts

3813 Ravenswood Ave.,

Chicago, Ill.

Subscribe to "RADIO" Now—\$1.00 Brings it to You for Six Months.

No bulbs to buy
No acids-No fumes

THE SILENT FRANCE MULTI-DUTY SUPER-CHARGER

No sticking or
sparking contacts

SPEED AND ECONOMY

In speed and economy, as in numerous other ways, the France Multi-Duty Super-Charger sets a new standard in battery charging. 2, 4, 6 or 8 volt Radio "A" or Auto batteries are quickly charged at a 5 to 7 ampere rate, which tapers as the battery is charged. It also charges up to 120 volts of "B" battery IN SERIES, at varying rates as desired, without attachments—a remarkable achievement. The France Multi-Duty Super-Charger is noiseless, non-critical, non-heating and exceptionally efficient. And there are no bulbs to break and replace nor acids to spill and spoil clothing or woodwork.



Now is the time to put your batteries in order. Write for name of nearest dealer. Price West of the Rockies, \$23.00.

Dealers and Jobbers:—Write us today for description and prices.

THE FRANCE MFG. CO.

10323 Berea Rd. Cleveland, Ohio

PACIFIC COAST BRANCHES:

LEE H. CRAIG CO. 75 Fremont St. San Francisco, Calif.
NORMAN COWAN CO. 53 Fourth St. Portland, Oregon

Single
Hole Mount

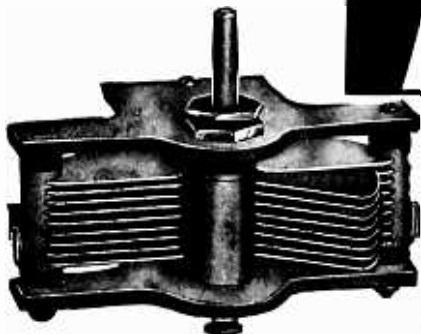

"NOL-LOS"

Variable Condenser \$4.00

Capacity .0005 M.F.

Perfection Reached at Last

"Nol-Los" is the acme of Radio development
"NOL-LOS CONDENSER"

Is the result of the most intensive study of radio experimenters to construct a Condenser that would co-ordinate mechanical designing and Radio designing so that losses are negligible. A single mount Condenser! Only one hole needed in panel. Mechanically rugged. Built almost entirely of aluminum, insuring rigidity as well as lightness. The "Nol-Los" condenser has been tested by some of the foremost technical laboratories in the world and proved to be equal in resistance to the standard condensers used by these laboratories.

SIMPLE AND ACCURATE TUNING

The "Nol-Los" condenser is so perfectly constructed that tuning is remarkably sharp, losses practically eliminated and reception made clearer. Made in three sizes. Capacities .0005, price \$4.00. .00035, price \$3.75. .00025, price \$3.50. When buying a condenser ask your dealer for "Nol-Los." If he cannot supply you, send direct to

B. Grosser Sons Co., Inc., Manufacturers

55A Sudbury Street

Dealers and Jobbers Write for Terms

Boston, Mass

AMERICAN BRAND CONDENSERS

with the

~100 to 1~

Worm Drive Vernier
Finest Condenser Made

and the

Greatest Radio Value
Offered the Public

23 PLATE, only \$5.00 In Canada \$7.00

AMERICAN BRAND CORPORATION
NEWARK, N.J.

REDUCE STATIC

Pat.
Pending
690459

by using our super-sensitive
Omni-Directional Aerial



Collapsible, Ornamental,
Mechanically Perfect

Can be used either as a loop
or antennae inside or outside.

A wonderful value featured at a
price within the range of all.

Ask your dealer or send order direct

\$10.00

Prepaid in U. S.

The Portable Globe Aerial Co.
1602 Locust Dept. 45 St. Louis

\$1.00 Brings "RADIO" for
6 Months

HOOVER SUGGESTS CON- TROL OF RADIO

Continued from page 107

character of its apparatus, and the time of transmission, shall be fixed by the Secretary of Commerce as in his judgment and discretion he shall deem expedient, and may be changed or modified from time to time in his discretion."

In the accompanying letter of transmittal Secretary Hoover states that "there is no monopoly in the radio world at the present time, there being over 500 broadcasting stations of which not more than four are the property of any one institution. With only 57 wavelengths and 500 stations—rapidly increasing—we are today forced to certain duplication of waves and to the division of time between stations.

"Beyond this three major things have developed during the last twelve months. The first is the interconnection of stations by which a single voice may be broadcast from all parts of the United States.

"During the past year there have been discoveries in the use of higher power and therefore larger areas of broadcasting, which may result in a single station being able to cover a large portion if not all of the country. This raises questions of the rights of local stations and the rights of local listeners.

"Still another development has been the fact that it has been found possible by indirect advertising to turn broadcasting to highly profitable use. If this were misused we would be confronted with the fact that service more advantageous to the listeners would be crowded out for advertising purposes.

"Because of this situation there is growing up a demand for the limitation of the number of stations in a given area and that such a limitation would be based on the service needs of the community.

"From all of this it seems to me that there is a tendency which may require an entirely different basis in character, theory and extent of legislation than any we have contemplated in the past. The basis of regulation and the fundamental policies to be followed must be finally declared by Congress, not left to an administrative officer. Hitherto, we have conceived the problem to be one of interference but there is now opening before us a whole vista of difficult problems. The development of the art is such that the whole situation is changing rapidly and the opinion of today on the solution for a given difficulty is worthless tomorrow. I hope that another year's experience will show what direction of legislative course must be pursued. Meantime I feel that we would be actual gainers by allowing the industry to progress naturally and unhampered except by the maintenance of a firm principle of government control of the ether and the elimination of interference so far as it is possible."

RADIOADS

A Classified Advertising Section Read by Better Buyers

The rate per word is five cents net. Remittance must accompany all advertisements.
Include name and address when counting words.

ADS FOR THE FEBRUARY ISSUE MUST REACH US BY JANUARY FIRST

C. W. and RADIO PHONISTS—Our new converters will satisfy your need for a more efficient and durable direct current plate supply. No armatures to burn out. Output from seven hundred to two thousand volts at .4 amperes. Synchronous Motors, Transformers and other parts sold separate. Write immediately, Kimley Equipment Mfg. Co., 290 Winslow Ave., Buffalo, N. Y. (to)

ARC & SPARK SYSTEMS
Send for Descriptive Circular QRD.
Interesting and Instructive (to)
Pacific Radio School 433 Call Bldg., San Francisco

Vacuum Tube Hospital
We repair and guarantee them.
Agents, Dealers, and Customers Wanted.
Radiotube Co., 903 Broad St., Newark, N. J. to

BIG Money and Fast Sales—every owner buys gold initials for his auto. You charge \$1.50, make, \$1.44. 10 orders daily easy. Samples and information free. World Monogram Co., Dept. 68, Newark, N. J. (SAS)

RADIO GENERATORS—500V 100 watt \$28.50
Battery Charging Generator \$8.50. High Speed Motors. Motor Generator Sets, all sizes. **MOTOR SPECIALTIES CO.**, Crafton, Penna. (to)

AGENTS WANTED TO ADVERTISE OUR GOODS
and distribute free samples to consumers; 90c an hour; write for full particulars. American Products Co., 2132 American Bldg., Cincinnati, O.

TELEGRAPHY—Morse and Wireless taught at home in half usual time and at a trifling cost. Omnigraph Automatic Transmitter will send, on Sounder or Buzzer, unlimited messages, any speed, just as expert operator would. Adopted by U. S. Government and used by leading Universities, Colleges, Technical and Telegraph Schools throughout U. S. Catalog free. Omnigraph Mfg. Co., 16 J. Hudson St., New York City.

AGENTS WANTED TO ADVERTISE OUR GOODS
and distribute free samples to consumers; 90c an hour; write for full particulars. American Products Co., 2132 American Bldg., Cincinnati, Ohio.

New Receiving Sets, fully guaranteed, at much below cost prices, because our customers are almost entirely BCL'S, who do not take to amateur receivers:
Zenith 1-R Receiver and 2-M Amplifier... \$90.00
Jones No. 503-J Detector and 3-step... 125.00
Kennedy Intermediate with Amplifier... 100.00
Grebe CR-5 Receiver... 50.00
Grebe CR-8 Receiver... 50.00
Grebe CR-12 Receiver... 125.00
Grebe RORN Radio Frequency Amplifier... 25.00
Federal No. 8 Detector and 1 step... 20.00
THE RADIO STORE,
560 E. Colorado Street, Pasadena, Calif.—(TC).

STORAGE "B" BATTERIES are easily made in one evening. Use my genuine Edison elements.
A. J. Hanks, 107 Highland Ave., Jersey City, N. J. (3T)

EVERYTHING FOR THE HAM
8BIN

1407 First North Street - Syracuse, N. Y. (2T)

RADIO Parts at Cost. Send for list. E. S. Morrison, Ashland, Oregon. (2)

Purest Virgin Aluminum for sale. Particulars upon request. 2EM.—(2T)

MAKE BIG MONEY OUT OF RADIO

Thousands of People want to buy a good Radio instrument. They have read that vast improvements have been made and they are ready to buy now if you show them the best.

It is one thing to make a good radio instrument for your own amusement, but why not cash in now on your experience? Let us send you full particulars of the Ozarka Plan which shows you how to

"MAKE \$120 WEEKLY"

selling long-distance Radio sets. The season is on right now. Let us tell you how to combine the clear signal of the crystal detector with the distance of the vacuum tube. Write today and don't fail to give the name of your county.

OZARKA INCORPORATED
814 Washington Blvd., Chicago

Model "C" super-heterodyne, loop, ten "A" tubes, Willard "A" and "B" batteries, large Magnavox. Complete outfit, \$325.00. Write for description.
E. S. Morrison, Box 22, Ashland, Oregon. (2t)

MAKE YOUR NEUT REACH OUT—Same panel, same layout, fewer parts. Our \$5.00 kit includes the one different part, 22 feet real gold sheathe wire, lithographed print of Kladag Coast To Coast Circuit, and complete, simple instructions. Nothing else to buy. Gives selectivity with deep, resonant volume. NOT obtainable elsewhere. We originated this and can name scores of buyers it has delighted. Satisfaction Guaranteed. Retail at 10c. Kit prepaid anywhere, \$5.00. New 48-page catalog, thousands of items, many exclusive, for stamp. We accept postage stamps, same as cash.
KLADAG RADIO LABORATORIES, Kent, Ohio.

1500 VOLTS FOR \$45!!!!!! Brand New General Electric ball bearing dynamotors, made for U. S. Naval Air Service, 24 volts D.C. input, 1500 volts 233 M.A. rated output for \$45.00. Will actually deliver about 600 M.A. for reasonable periods. With shafts extended, make fine D.C. double current generators, and will give above from low and high tension ends. Shafts extended for \$3.00 extra. Make fine battery chargers. Also fine for portable sets, and can use on lower input voltages and get lower plate supply. 6 volts will give approximately 375 volts, 12 input 750 volts, etc. Also with 750 volt tap for regular operation on smaller tubes. Prices F.O.B. San Francisco, Cal. D. B. McGown, 1247 47th Avenue, San Francisco, Calif.

WESTERN ELECTRIC 7A Amplifier, 216A Tubes, 518W Speaker, \$100.00. 216A Tubes \$8.00. 14 Giblin-Remler Coils \$12.00. Wendell Fletcher, 334 West Islay, Santa Barbara, Calif.

SENTINAL RADIO FUSES in all capacities from 5 ampere for the filament lines to MINIMUM capacity for the plate circuit cost ten cents each, or one dollar per doz. postpaid. Why take chances? Put a Sentinal in every battery line and be safe.
Davis Electric Co., Springfield, Ohio.

Why not build your own Edison rechargeable "B" battery? A few hours time will do it!—Large size, clean Edison elements, wired with pure nickel wire, electrically welded connections, .07 1/2 per pair prepaid, anywhere. Sample and "dope" sheet, 10 cts. Unwired elements .05 pair; nickel wire .01 1/2 per foot; rubber separators, 1/2 cent each. Orders shipped same day received.
Arthur Chapelle, Woodburn, Ore. 7NX

2650 MILES DISTANCE with one tube. Any novice understands our Simplified Instructions including Panel Layout, picture diagrams, etc. Write for **BIG FREE BOOKLET.** **VESCO RADIO CO., BOX 117-RC, OAKLAND, CAL. (TC)**

QSL Cards—Samples and prices cheerfully furnished
8BJT, 701 Walnut Ave., Scottsdale, Pa.

RADIO PARTS: Four genuine 6 volt Radiotron tubes \$3.50 each, 2 Acme vernier variable condensers \$4.50 each, 3 Remler intermediate frequency transformers \$5.00 each, 1 Remler tuned stage radio frequency transformer \$4.00, 2 Eveready 45 volt B Batteries \$3.00 each. Entire lot postpaid \$45.00. All new equipment and guaranteed satisfactory. R. S. Clayton, 109 Daniels Ave., Vallejo, Calif.

VOLUME WITHOUT DISTORTION. Use "NORMA" 1-1 Power Transformers after first stage. Guaranteed. Postpaid, \$9.00. \$6.50 unmounted. Agents wanted. 4424 View Street, Oakland, Calif.

FOR SALE. Paragon RA-10 Tuner with detector and 2 stage amplifier, \$60.00. Magnavox AC-2 2 stage power amplifier \$32.00. Weston 0-200 milliammeter new \$5.25. RCA R.F. ammeter 0-25 \$2.15. RCA Filter Reactor 150 milliamp. \$6.00. William Gray, Jr., Milford, Delaware.

Motor and Generator Bargains: One 1/4 HP Westinghouse 1750 RPM 110 volt single phase motor, new, \$35.00. One two HP single phase Century Motor, 1750 RPM, 110 or 220 volts, second hand, but in good shape, with sliding base and pulley, \$50.00 (list about \$110.00). One 8 and 600 volt GE generator, 5000 RPM, made for British air service, \$20.00. Several other good bargains. Also 500 cycle generators, from 1/4 to 2 KW, priced right.
D. B. McGown, 1247 Forty-seventh Avenue, San Francisco, Cal.

PRINTING—Radio QSL cards. Many different styles 60c per hundred and up. **LARGE RED** call letters. Also Radiograms, Stationery and BCL Cards. Send for complete set of samples. The **ARTHUR PRESS, 1453 Arthur Ave., LAKEWOOD, Ohio.**

Radio parts at cost. Send for list. E. S. Morrison, Ashland, Oregon. (6TJ25)

MAGNADYNE REFLEX COILS

TWO DOLLARS A PAIR

Adaptable to every reflex set

Advantages

Efficiency of operation
Reduces dielectric losses
Minimizes distributed capacity

Get more enjoyment from your radio set. Mail us check for \$2.00 and receive a pair of coils, post paid.

Dealers write for our Proposition

COAST COUPLER CO.

EAST SEVENTH ST.
Long Beach, California

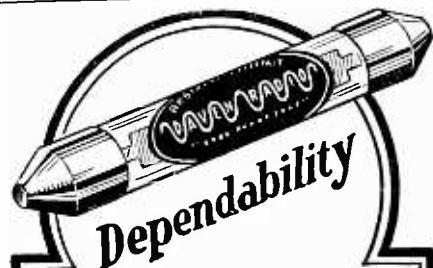

Dependability is another word for Reputation.

Have you noticed how many prominent writers and engineers specify

Daven Grid Leaks?

SOLD EVERYWHERE

Read the "RESISTOR MANUAL," a 32-page handbook on Resistance Coupled Amplification with interesting data and hook-ups.

Price 25 cents
At your dealers

DAVEN RADIO CORP.

Resistor Specialists"

Newark, New Jersey

Pacific Representative:
W. J. RHYNSBURGER
500 Citizens Nat. Bk. Bldg.,
Los Angeles

CLARK & TILSON INC.

Wholesale Distributors
of Nationally Known

RADIO SUPPLIES

Since 1921

DEALERS send for price list
and discount sheet

554-A Seventh Ave.
New York City

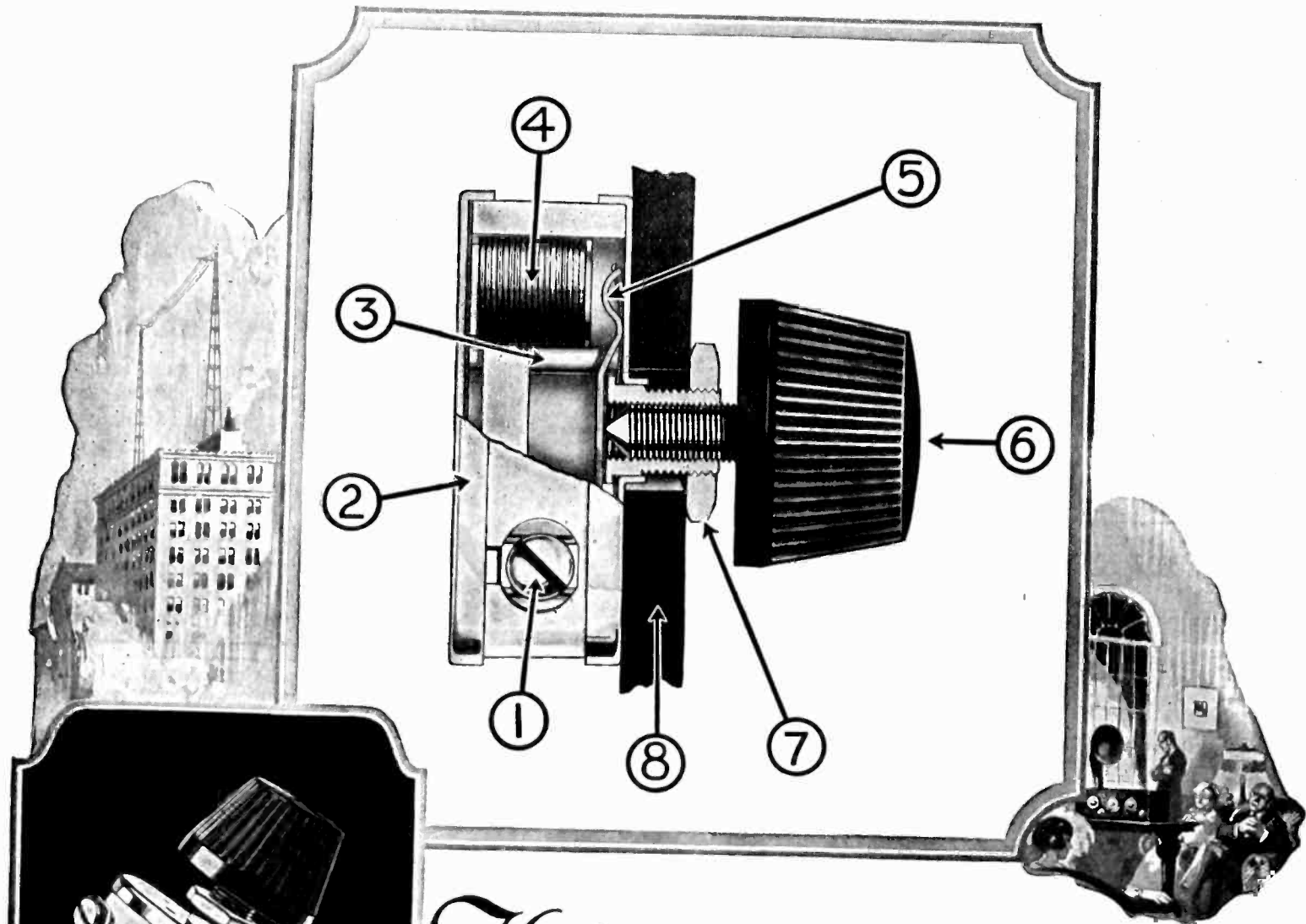

The New Bradleystat

Supreme in design and performance

ASIDE from the novel "one-hole mounting" that characterizes the Allen-Bradley line of radio devices, the most striking new feature is the extreme compactness of the graphite disc container. When mounted on panel, the new Bradleystat extends less than three-quarters of an inch behind the panel. The same is true of the Bradleyleak and the Bradleyohm. And the Bradleyometer extends only seven-eighths of an inch. You can improve your radio set immensely by substituting a Bradleystat for your present wire rheostat or a Bradleyleak for your old grid leak. There's plenty of room. Try it!

Important Features

- 1 Two terminals suffice for ALL Tubes.
- 2 Back-panel extension is 11/16 inch.
- 3 Holes for table mounting are provided.
- 4 Graphite discs give stepless, noiseless control.
- 5 Internal switch opens battery circuit.
- 6 One knob provides control from 1/4 to 100 ohms.
- 7 One locknut holds Bradleystat securely in position.
- 8 Drill only one hole in panel.



Allen-Bradley Co.
 Electric Controlling Apparatus
 288 Greenfield Ave. Milwaukee, Wis.

- | | | | | | |
|------------|------------|-----------|-------------|--------------|---------------|
| Baltimore | Buffalo | Cleveland | Knoxville | Philadelphia | Saint Paul |
| Birmingham | Chicago | Denver | Los Angeles | Pittsburgh | San Francisco |
| Boston | Cincinnati | Detroit | New York | Saint Louis | Seattle |

NEW GENERAL RADIO PRODUCTS

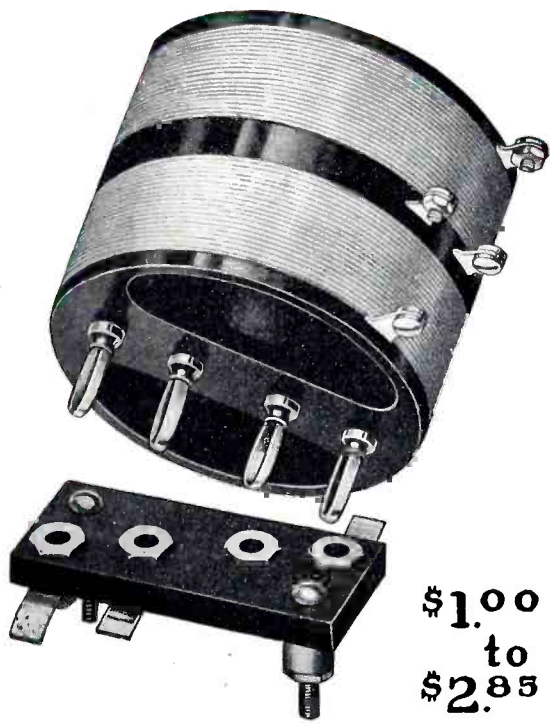

\$1.00
to
\$2.85

New Low Loss Coils

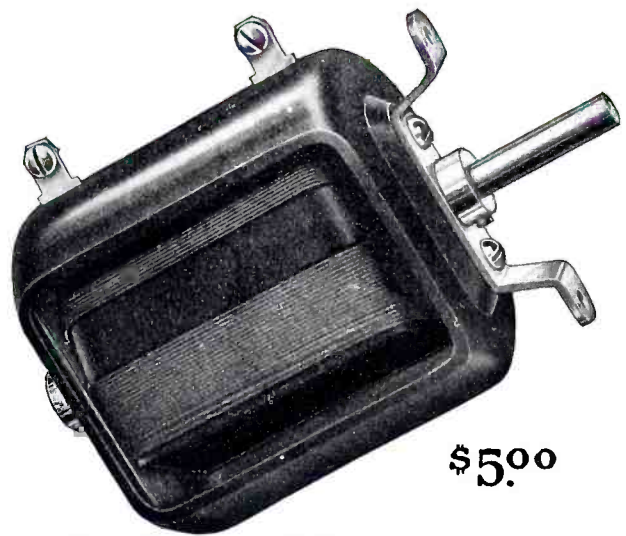

\$5.00

A New Variometer

Radio Builders and Experimenters—here are the newest additions to the well known General Radio line of Quality Parts!

A Variometer unusually compact in size and efficient in operation.

Low Loss Coils that mount as easily as a vacuum tube—ideal for oscillator and antenna coupling coils for superheterodyne circuits.

The New General Vernier Dial—an improvement in the appearance and operation of any well planned set.

They are all popular instruments selling at popular prices.

See them at your dealers or write for our new radio catalog 919-U

GENERAL RADIO CO.
CAMBRIDGE, MASS.

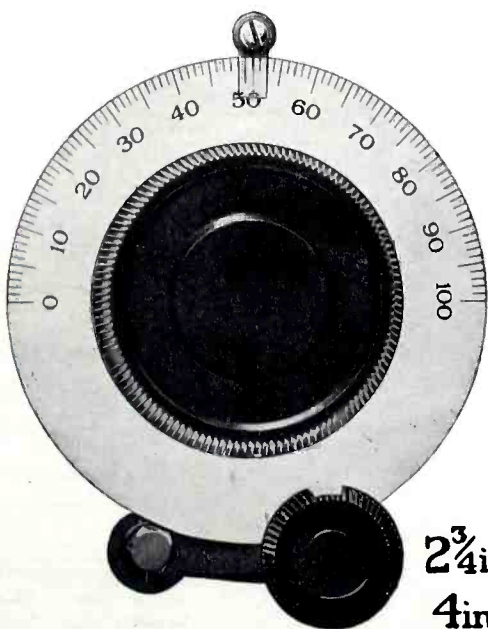

2 3/4 in. \$1.50
4 in. \$2.50

New Geared Vernier Dials



Radiotron WD-11.
The ideal dry cell
tube.

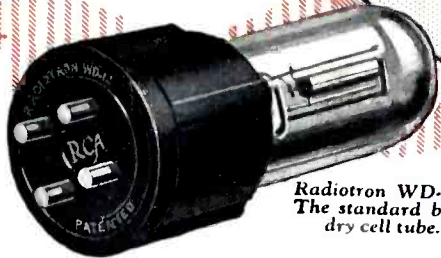

Radiotron WD-12.
The standard base
dry cell tube.



Get a good detector

Radiotrons WD-11 and WD-12 are the same tube but with different bases.

Radiotron WD-12 has a standard navy-type base. With it, you can change your set to dry battery operation. Ask your dealer today.



This symbol of quality
is your protection

What will Radiotron WD-11 and WD-12 do as detectors? First—they are sensitive to weak signals—superlatively sensitive, as remarkable distance performances show in thousands of one-tube sets. Second, they are good “oscillators”—and that is important in regenerative circuits. And third, they are quiet in operation—add no electrical noises to the music, or speech. Radiotrons WD-11 and WD-12 are famous as audio and radio frequency amplifiers—too—and have made possible the hundreds of thousands of dry battery receivers that are in use today. They mean clear, true reception—over big distances—with dry batteries. Be sure to get a genuine Radiotron.

Radio Corporation of America

Sales Offices: Suite No. 51

233 Broadway, New York 10 So. La Salle St., Chicago, Ill. 28 Geary St., San Francisco, Cal.

Radiotron

REG. U. S. PAT. OFF.